

SURPAD 4.2

USER GUIDE

For Android Platform

V1.1

Copyright © Shanghai eSurvey GNSS Co., Ltd. 2021. All rights reserved.

No part of this document may be reproduced or transmitted in any form or by any means without prior written consent of Shanghai eSurvey GNSS Co., Ltd.

Trademarks and Permissions

 and other eSurvey trademarks are trademarks of Shanghai eSurvey GNSS Co., Ltd.

All other trademarks and trade names mentioned in this document are the property of their respective holders.

Notice

The purchased products, services and features are stipulated by the contract made between eSurvey and the customer. All or part of the products, services and features described in this document may not be within the purchase scope or the usage scope.

The information in this document is subject to change without notice. Every effort has been made in the preparation of this document to ensure accuracy of the contents, but all statements, information, and recommendations in this document do not constitute a warranty of any kind, express or implied.

Contents

1	SurPad at a Glance	1
1.1	Status Bar	2
1.2	Menu Bar	2
2	Quick Start	3
2.1	Prepare before Start	4
2.1.1	Install the SurPad	4
2.1.2	Activate the SurPad	5
2.2	Create a New Project and Set Coordinate Parameters	6
2.3	Connect to the Receiver	8
2.4	Set the Static Station	9
2.5	Set the Base Station	10
2.6	Set the Rover Station	11
2.7	Do Surveying	11
2.8	Export Data	13
4	Project	14
4.1	Project Manager	14
4.1.1	Modify the Project Directory	15
4.1.2	Create a New Project	16
4.1.3	Select a Existed Project	16
4.1.4	Export a Project	16
4.1.5	Check / Modify Project Information	17
4.2	Project Data Manager	18
4.2.1	Create a New Data File	18
4.2.2	Import a Data File	19
4.2.3	Delete a Data File	20
4.2.4	Switch between Different Data Files	20
4.3	Coordinate System	20
4.3.1	Set Coordinate Parameters	21
4.3.2	Use Existing Coordinate Parameters	22
4.3.3	Export Coordinate Parameters	22
4.4	Calibrate a Point	23
4.4.1	Do Base Point Calibration	24
4.4.2	Do Marker Point Calibration	27
4.5	Point Database	30
4.5.1	Find the Existed Point	30
4.5.2	Add a New Point	31
4.5.3	Edit a Point	33
4.5.4	Check Point Information	34
4.5.5	Import a Point	35

4.5.6	Delete a Point.....	38
4.5.7	Filter Points	39
4.5.8	Recover Points	40
4.5.9	Share a Point.....	41
4.5.10	Modify Antenna Parameters	42
4.6	Export File	43
4.6.1	Export a File in a Specified Format	43
4.6.2	Export a File in a User-defined Format.....	44
4.6.3	Export Road Cross-section.....	46
4.7	Scan QR Code.....	47
4.8	Cloud Settings	48
4.9	Software Settings	49
4.10	About Software	49
4.10.1	Write Feedback	50
4.10.2	Activate the SurPad.....	50
4.10.3	Check the Latest Version	50
5	Device	51
5.1	Communication	51
5.2	Rover	52
5.2.1	Set the Data Link.....	52
5.2.2	Set Advanced Settings	54
5.3	Base.....	55
5.3.1	Set the Startup Mode	56
5.3.2	Set the Data Link.....	58
5.3.3	Set Advanced Settings	59
5.4	Static.....	60
5.4.1	Set Option Settings	60
5.4.2	Set Antenna Parameters	61
5.4.3	Set Advanced Settings	62
5.5	Work Mode Status	63
5.6	Configurations	64
5.6.1	Create a New Configuration File	65
5.6.2	Check Details	66
5.6.3	Apply the Configuration File	66
5.7	Device Information	67
5.8	Inspection Accuracy	68
5.8.1	Inspect Accuracy of Tilt Measurement	68
5.8.2	Calibrate the Pole.....	70
5.9	Calibrate Sensor	71
5.10	Device Settings.....	72
5.11	Default Radio Settings	73
5.12	Restart Positioning.....	73
5.13	Device Activation.....	74

6	Survey	75
6.1	Point Survey	75
6.1.1	Enable IMU Tilt Measurement	81
6.1.2	Manage Point Database	81
6.1.3	Set Display Information	81
6.1.4	Start Point Survey	84
6.2	Detail Survey	97
6.3	CAD	99
6.3.1	Manage the Layer	100
6.3.2	Import / Export a CAD File	103
6.3.3	Draw an Object	104
6.3.4	Start Survey	105
6.3.5	Use CAD Tools	106
6.3.6	Delete CAD Data	108
6.3.7	Check Object Information	109
6.3.8	Explode a Polyline	110
6.3.9	Check Coordinates	110
6.3.10	Start Stakeout	111
6.4	Point Stakeout	113
6.4.1	Manage Stakeout Point Database	115
6.4.2	Set Display Information	116
6.4.3	Start Point Stakeout	117
6.5	Line Stakeout	119
6.5.1	Manage Line Database	120
6.5.2	Set Stakeout Settings	121
6.5.3	Set Display Information	122
6.5.4	Add a Stake	123
6.5.5	Start Line Stakeout	125
6.6	GIS Data Collection	126
6.6.1	Add an Entity Element	128
6.6.2	Start GIS Data Collection	131
6.7	Stake Road	131
6.7.1	Add a New Road Stakeout	132
6.7.2	Manage Road Stakeout Database	151
6.7.3	Switch the Road Stakeout Mode	151
6.7.4	Set Display Information	152
6.7.5	Start Road Stakeout	153
6.8	Stake Road by Point	155
6.8.1	Set Stakeout Settings	156
6.8.2	Add a New Road Stakeout	156
6.8.3	Manage Road Stakeout Database	156
6.8.4	Set Display Information	157
6.8.5	Start Road Stakeout by Point	157
6.9	Cross Section Measurement	157

6.9.1	Set Stakeout Settings	158
6.9.2	Add a New Stakeout Road	159
6.9.3	Manage Road Stakeout Database	159
6.9.4	Set Display Information	159
6.9.5	Start Cross Section Measurement.....	159
6.10	Layers Settings.....	160
6.10.1	Set Drawing Layer	160
6.10.2	Set Background Layer	161
6.11	Survey Range Settings	163
6.11.1	Add a Survey Range	165
6.11.2	Draw a Survey Range by CAD	166
7	Tools.....	167
7.1	Localization.....	167
7.1.1	Add a Localization Point	168
7.1.2	Edit a Localization Point	169
7.1.3	Delete a Localization Point	169
7.1.4	Set Localization Settings	170
7.1.5	Get the GPS Parameter Report.....	171
7.1.6	Import Localization Points	172
7.1.7	Export Localization Points	172
7.2	Coordinates Converter.....	173
7.2.1	Convert a Single Point.....	173
7.2.2	Convert a File	174
7.3	Angle Converter.....	175
7.4	Perimeter and Area.....	176
7.4.1	Add a New Point.....	177
7.4.2	Edit a Point.....	177
7.4.3	Calculate Perimeter and Area	178
7.5	COGO Calculation	178
7.6	Calculator	180
7.7	External Radio Configuration	181
7.8	Volume Calculation	191
7.9	Add Offsets to Points at Specified Period.....	195
7.10	FTP Shared Data.....	198
7.11	Share	199
7.12	Grid to Ground.....	200

1 SurPad at a Glance



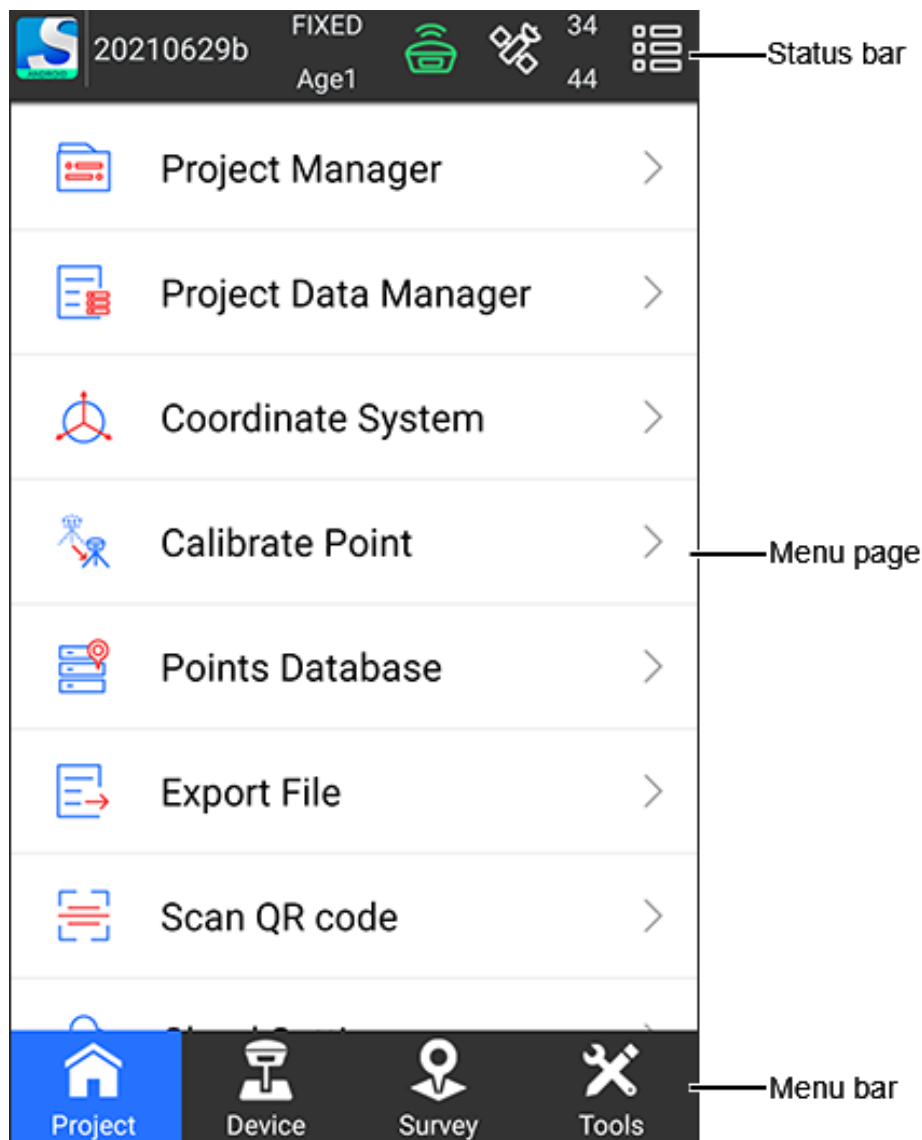

Based on the Android platform, SurPad is a GNSS surveying and mapping software, developed by e-Survey. Combining with the international mainstream of surveying and mapping data acquisition function, it integrates RTK control, GIS data collection and road design and layout into one role.

With graphic interaction, SurPad is very powerful but easy-to-use. Its interface layout is as follows:

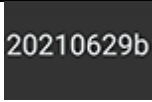
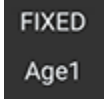

1.1 Status Bar

This part gives information about SurPad and the receiver:

Status icon		What it does
	About software	To submit your feedback about the software, activate the software, and update the software.
	Project name	To show the name of the current project.
	Solution status and delay	To show the solution status (including single, float, differential and fixed) and the differential delay in real-time.
	Communication	To show the connection status between the receiver and device. Green: connection succeeds. White: connection fails.
	Positioning information	To check the current positioning information.
	Satellites count	To show the used satellites number (e.g. 34) and the observed satellite number (e.g. 44).
	Main interface setting	To set the interface style to List or Grid , and set whether to enable general function, road function, electric function and other function which are enabled by default.

1.2 Menu Bar

This part gives access to the software functions:

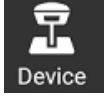
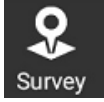
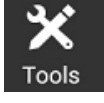
Menu		What it does
	Project menu	To manage project operations. See 3 Project for details.
	Device menu	To set operation mode and check information of the receiver after connecting to the receiver. See 4 Device for details.
	Survey menu	To start your survey work. See 5 Survey for details.
	Tools menu	To select various calculation methods. See 6 Tools for details.

2 Quick Start

To learn how to get your SurPad software up and running.

The process of quick start is as follows:

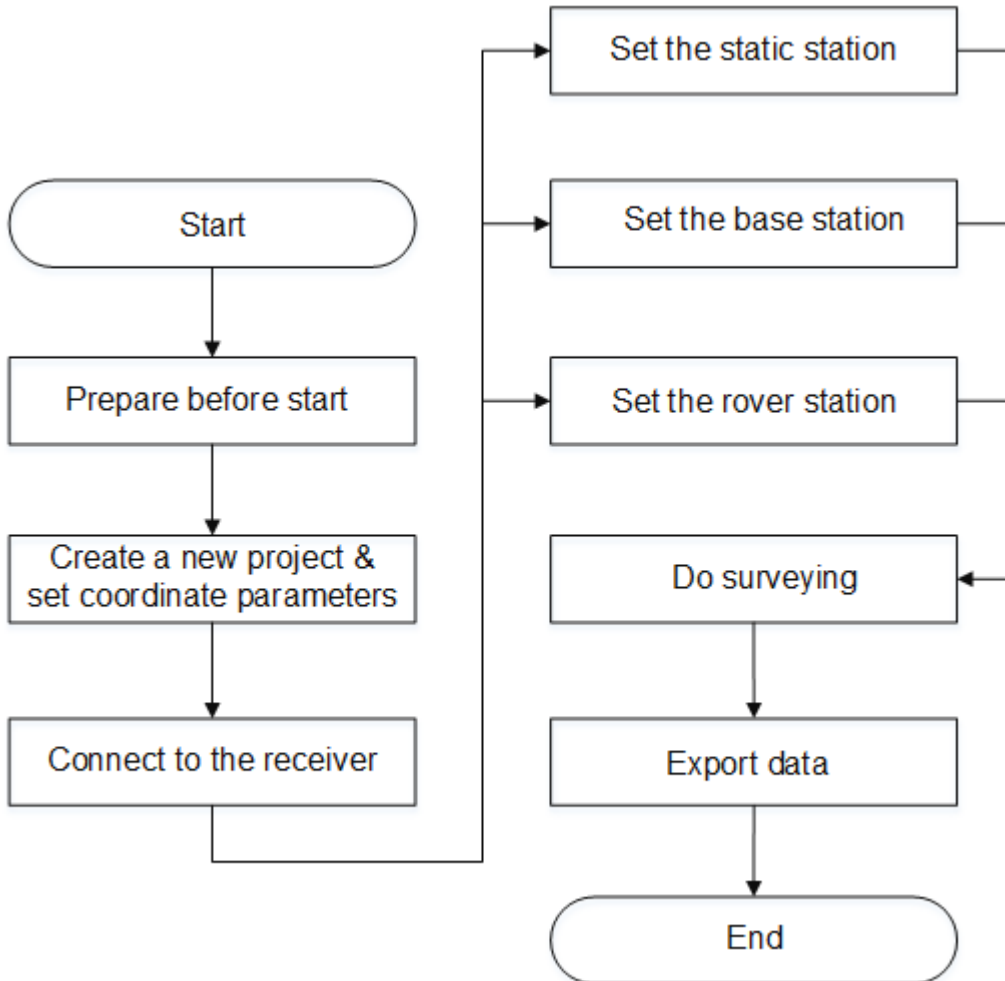

2.1 Prepare before Start

It is used to make sure that your SurPad can work and run normally.

To prepare before start, do the following:

1. Prepare the following:
 - Two GNSS receivers (one base station and one rover station)
 - An Android device with network connected.
2. Install the SurPad.
3. Activate the SurPad.

2.1.1 Install the SurPad

It is used to make sure the SurPad can be correctly installed in your Android device.

To install the SurPad, do the following:

1. Download the Android SurPad installation package (*.apk), and copy it to an Android device.
2. Find the installation package in **File Manager** in Android device.
3. Press the installation package, and press **INSTALL** in the following prompt:

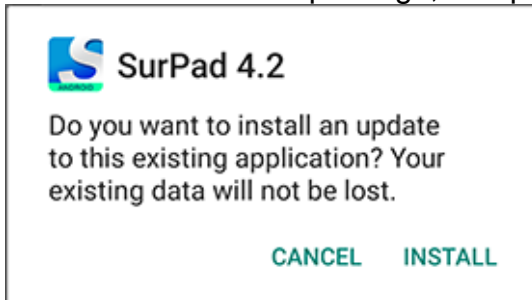

4. After a prompt *App installed* shows, press one of the following:
 - **DONE**: to return to the path where the installation packages puts.
 - **OPEN**: to open SurPad software.

After installing the SurPad, to uninstall it, do one of the following:

- Long press the software icon on the desktop and drag it to **Uninstall** box.
- Press **Settings** → **APPS**, find SurPad, and press **SurPad** and **Uninstall**.

2.1.2 Activate the SurPad

When you start SurPad at the first time, registering your license of the software is required. Otherwise, you cannot use SurPad normally.

To activate the SurPad, do the following:

1. To enter **Software Activation** interface, in the status bar, press  → **Software activation**:

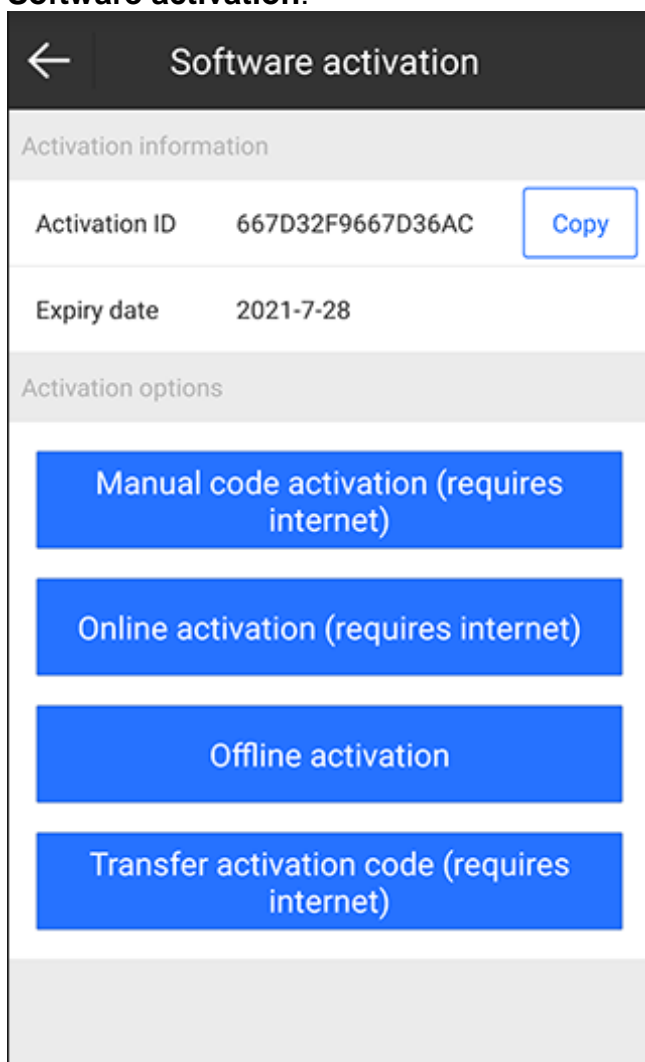

Alternatively, press main menu **Project** → **About Software**, and press **Software Activation**.

2. Select one of the following methods to activate your SurPad:
 - **Manual code activation**: internet is required.
 - **Online activation**: internet is required.
 - **Offline activation**: internet is not required.
 - **Transfer activation code**: internet is required. With this code, you can use SurPad on different devices.

2.2 Create a New Project and Set Coordinate Parameters

In general, when you begin to measure an area at the first time, you need to create a project file matched with the current project coordinates.

After the project has been created, a file folder whose name is the same with the project will be created to save all data under directory *SurPad/Project* in your Android device.

To create a new project and set coordinate parameters, run SurPad, and do the following:

1. To enter **Create Project** interface, press main menu **Project** → **Project Manager**, and press **New**:

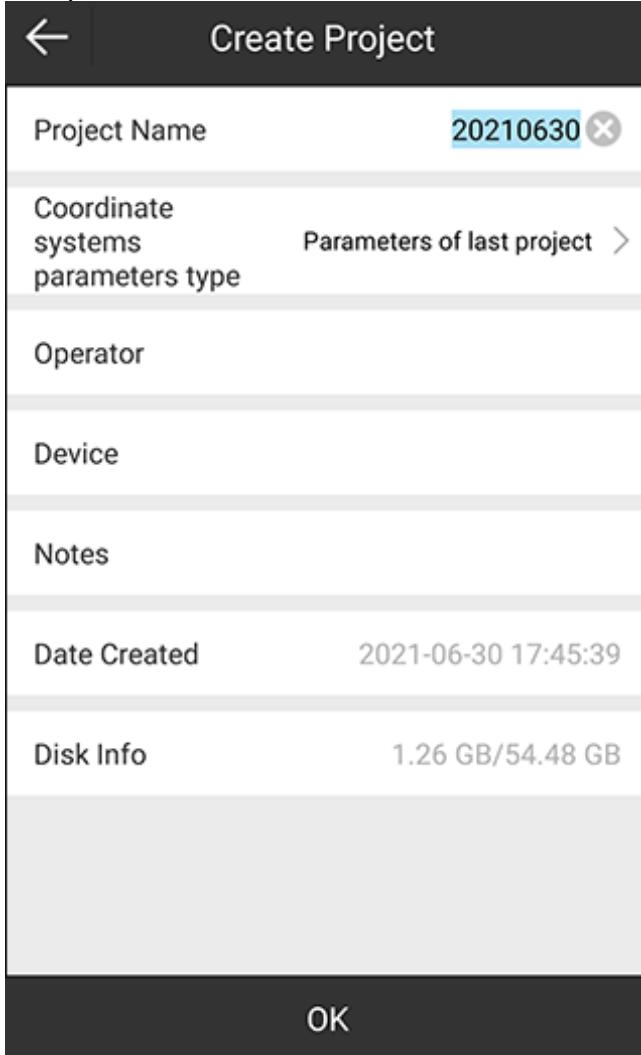

The screenshot shows the 'Create Project' screen with the following details:

- Project Name:** 20210630 (with a clear button)
- Coordinate systems parameters type:** Parameters of last project (with a right arrow)
- Operator:** (empty field)
- Device:** (empty field)
- Notes:** (empty text area)
- Date Created:** 2021-06-30 17:45:39
- Disk Info:** 1.26 GB/54.48 GB
- Bottom Button:** OK

2. Set the following required parameters:
 - **Project Name:** the created date by default.
 - **Coordinate systems parameters type:** including parameter of last project, local parameters, RTCM1021~1027 parameters, and CORS encrypted parameters.
3. **Optional:** Set the following additional parameters based on your need:
 - **Operator**
 - **Device**
 - **Notes**
4. Press **OK**.

5. **Optional:** If **Coordinate systems parameter type** is set to **Parameter of last project** or **Local parameters**, set the coordinate system parameters in **Coordinate Systems Parameters** interface:

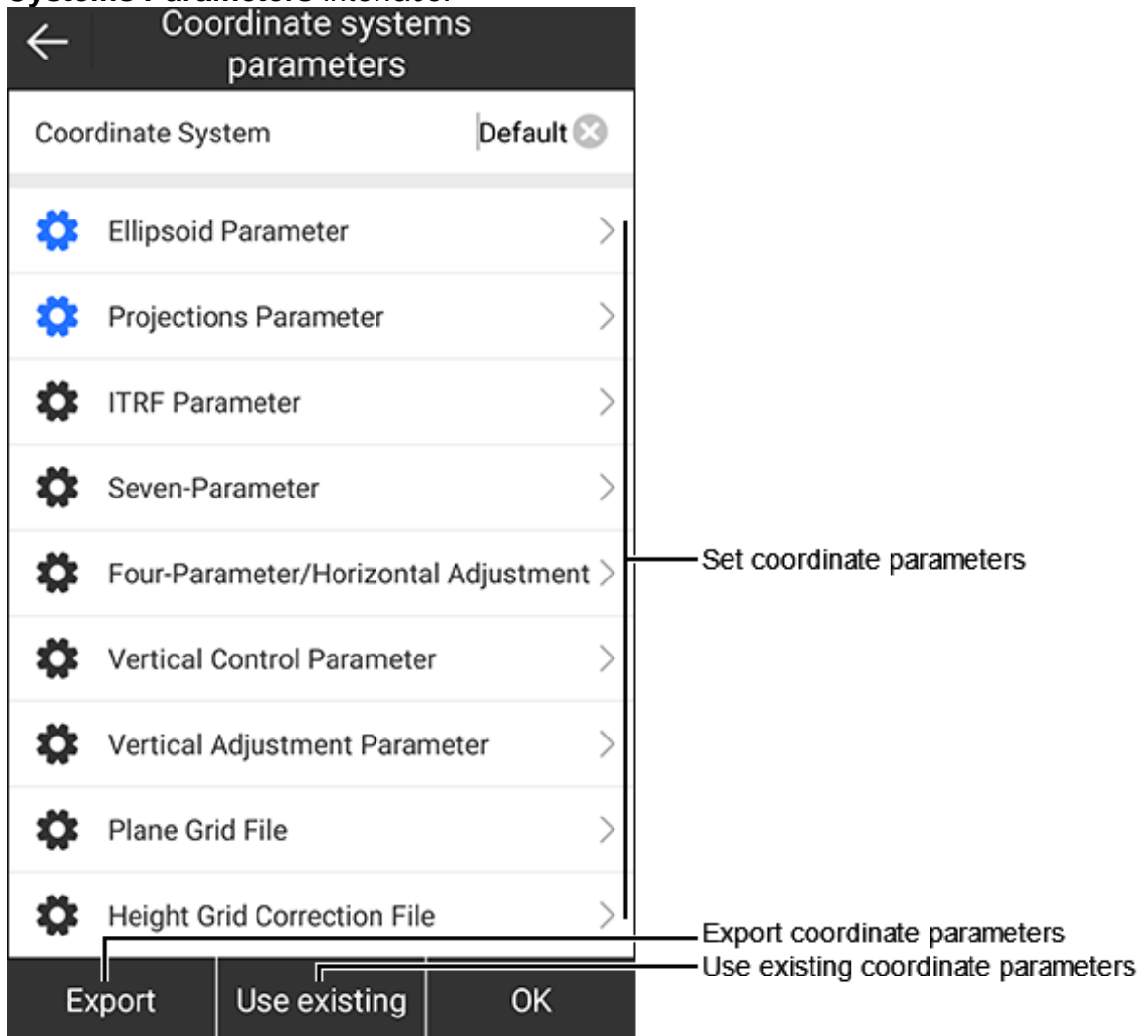

See [3.3](#) Coordinate System for details.

2.3 Connect to the Receiver

It is used to establish the communication between the receiver and the SurPad.

To connect to the receiver, do the following:

1. To enter **Communication** interface, press main menu **Device** → **Communication**:

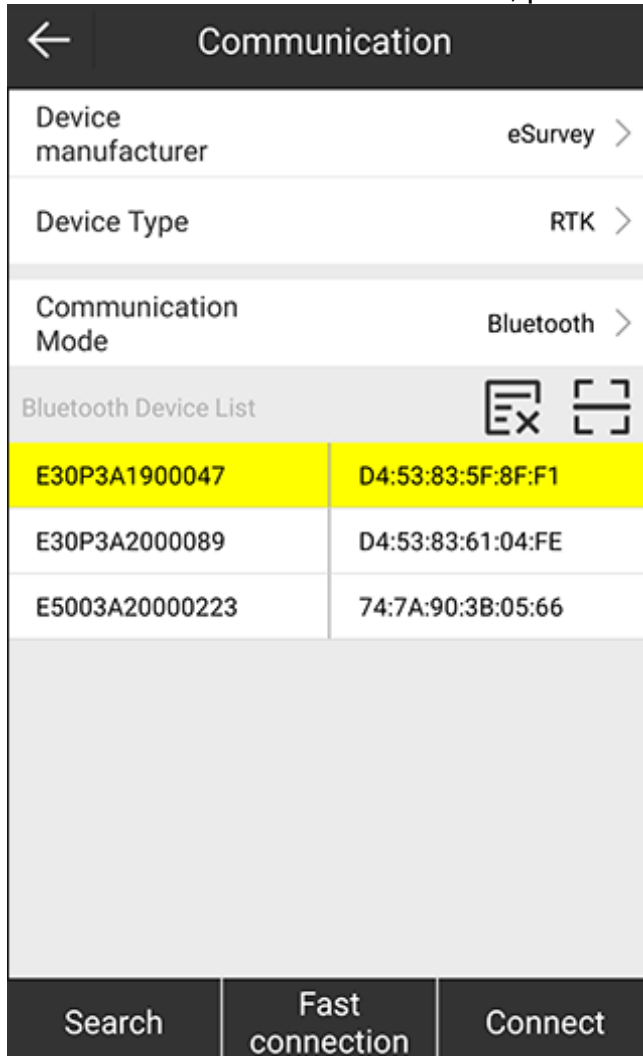

2. Select the device manufacturer and the device type.
3. Select one of the following communication modes:
 - **Bluetooth**: to connect the receiver by Bluetooth. Its operation is the same with WIFI operation.
 - **WIFI**: to connect the receiver by WIFI. Its operation is the same with Bluetooth operation.
 - **Serial port**: to connect the receiver with a data cable by setting port and baud.
 - **Demo**: to check and try out various functions of SurPad in demo mode by setting coordinates of the start point.

4. Taking the communication mode **Bluetooth** as an example, to set the communication mode, do the following:
 - a. To find receivers in **Bluetooth Device List**, press **Search**.
 - b. When the receiver you need to connect shows in the device list, press **Stop**.
 - c. Press the target Bluetooth, and press **Connect**.



CAUTION: Fast Connection is to search the signal around and automatically connect to the strongest one.

- d. **Optional:** Press **Pair** in the pairing prompt if it is the first time to connect to the receiver.

2.4 Set the Static Station

It is used to set the static, including configuration, option settings, antenna parameters, etc.

See [4.4 Static](#) for details.

To set the base station, do the following:

1. To enter **Static Mode Settings** interface, press main menu **Device** → **Static**:

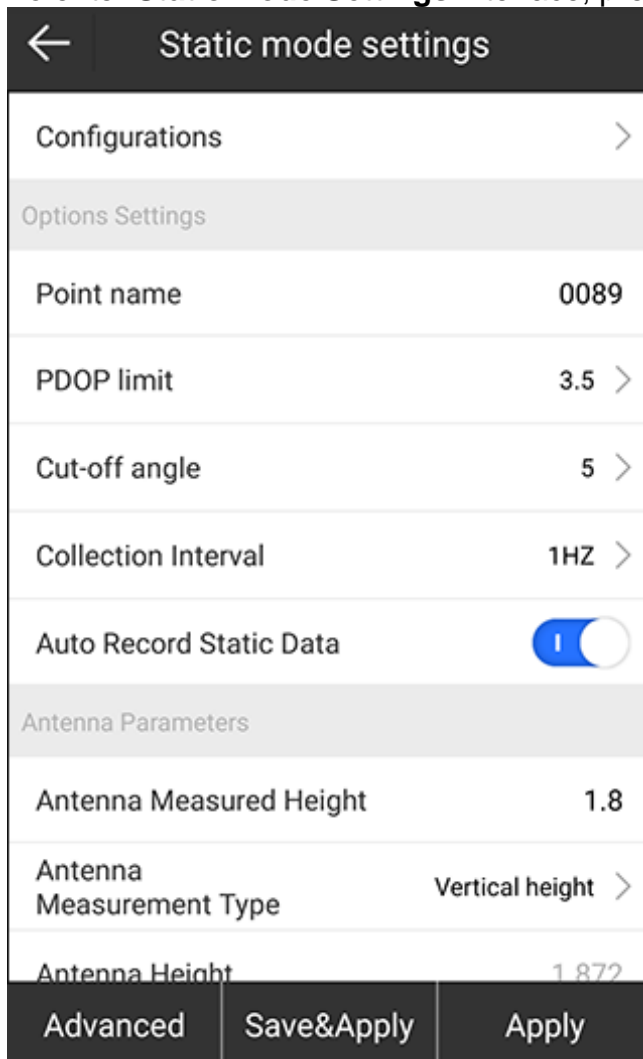

2. Press **Configurations** to select the configuration.

3. In **Options Setting** area, set point name, PDOP limit, cut-off angle, collection interval, and automatic static data recording.
4. In **Antenna Parameters** area, set antenna measured height, antenna measurement type and antenna height.
5. Press **Apply**.

2.5 Set the Base Station

It is used to set the base, including configuration, base ID, start up mode, differential mode, base startup, raw data recording, data link, etc.

See [4.3 Base](#) for details.

To set the base station, do the following:

1. To enter **Base Mode Settings** interface, press main menu **Device** → **Base**:

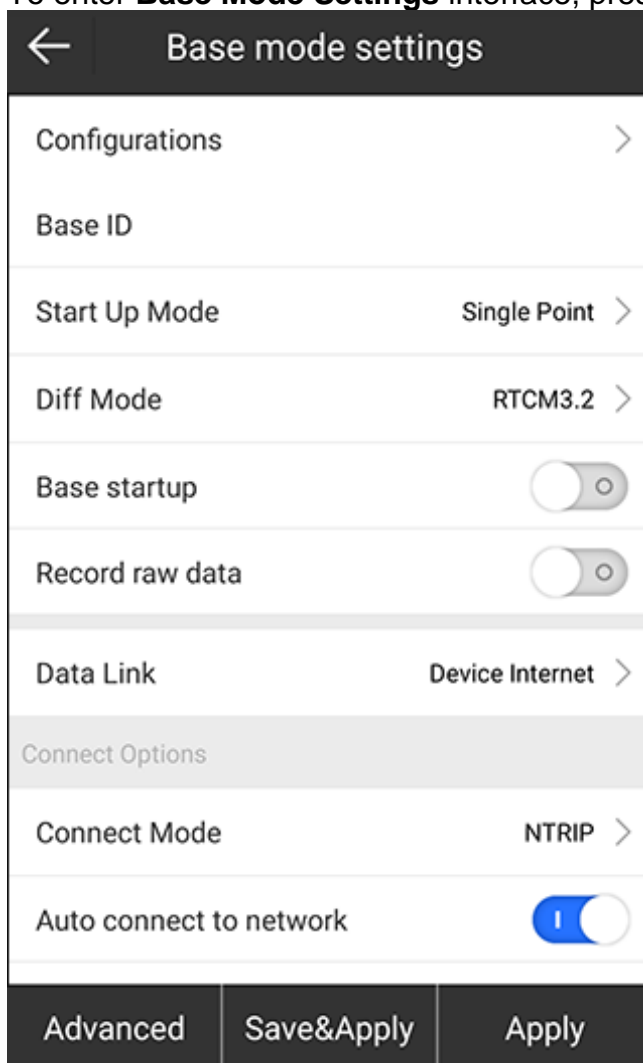

2. Press **Configurations** to select a saved configuration.
3. Set Base ID.
4. Press **Start Up Mode** to set a start up mode.
5. Select whether to enable base startup and record raw data.
6. Press **Datalink** to select a way to transmit differential signals.
7. Press **Apply**.

2.6 Set the Rover Station

It is used to set the rover, including configuration, cut-off angle, raw data recording, aRTK, aRTK age limit, data link, etc.

See [4.2 Rover](#) for details.

To set the rover station, do the following:

1. To **Rover mode settings** interface, press main menu **Device** → **Rover**:

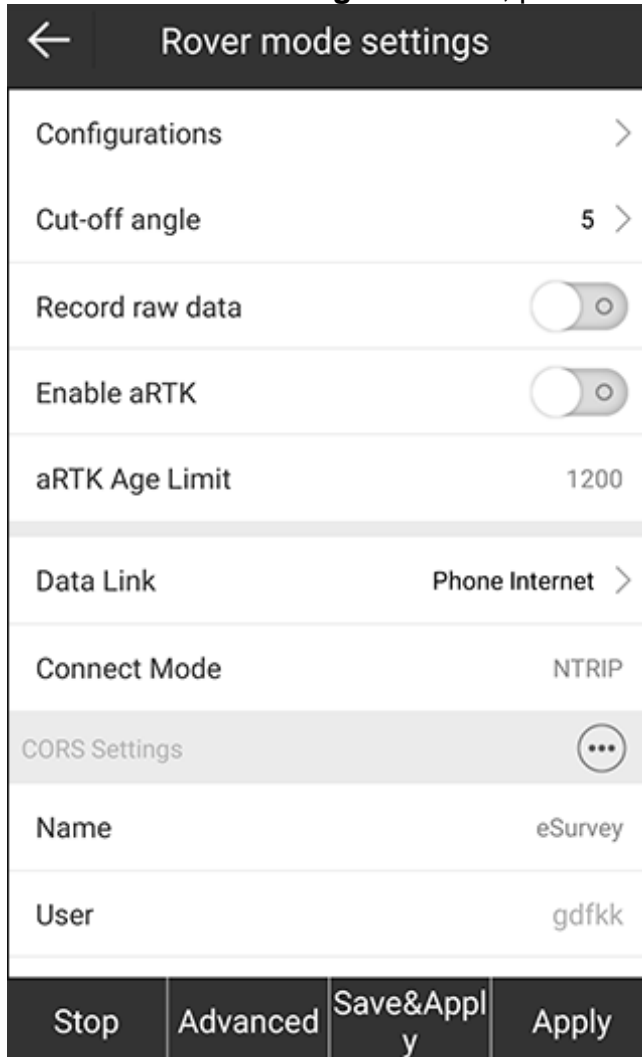

2. Press **Configurations** to select a saved configuration.
3. Set or select the cut-off angle.
4. Select whether to record raw data and enable aRTK.
With raw data recorded, you can input point name and collect post-differential point.
5. Set the aRTK age limit.
6. Press **Data Link** to select a way to transmit differential signals.
7. Press **Apply**.

Return to the main interface to see if the status is fixed solution  in the status bar.

2.7 Do Surveying

It is used to start your surveying work.

See [5.1 Point Survey](#) for details.

To do surveying, do the following:

1. To enter the main interface of point survey, press main menu **Survey** → **Point Survey**:

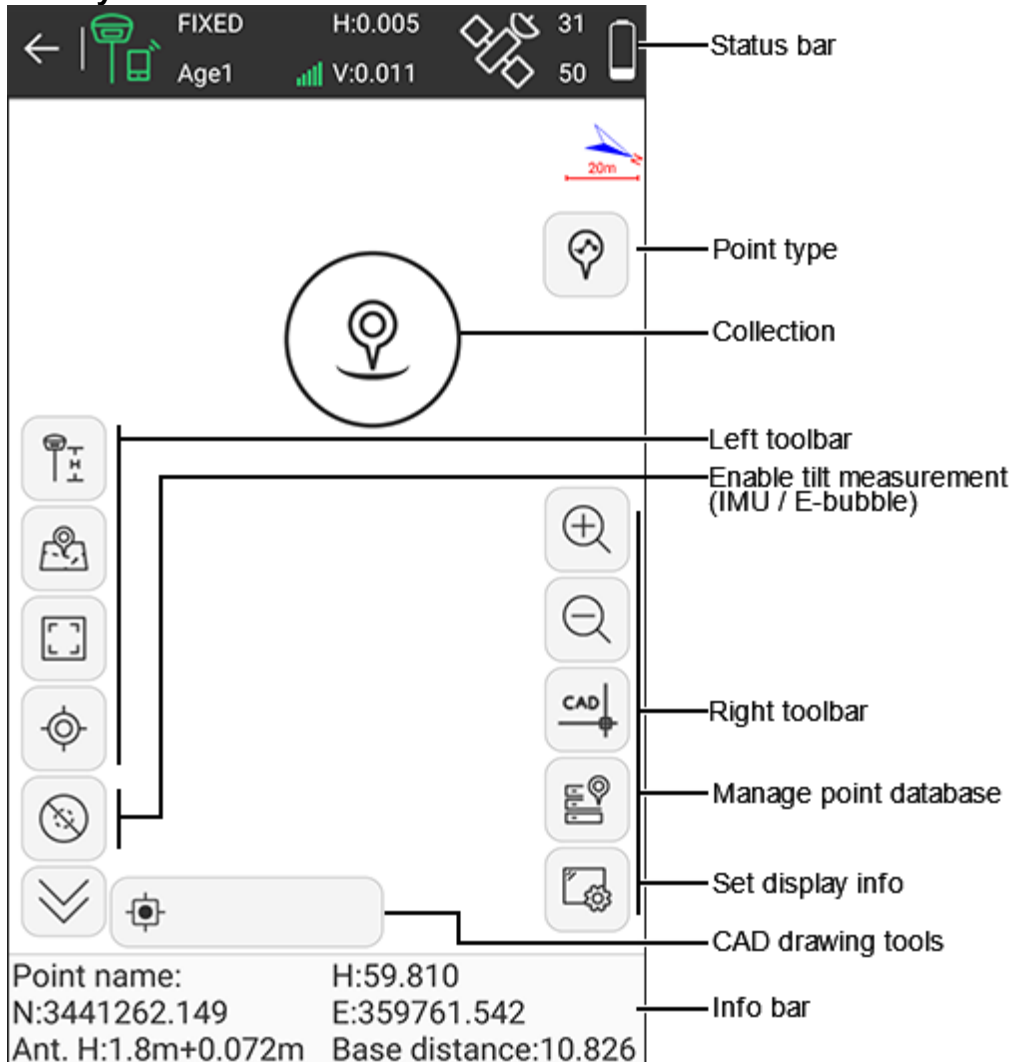

2. Press  and select a point type.

3. **Optional:** Press  and enable tilt measurement.

4. **Optional:** Press  and manage point database.

5. **Optional:** Press , and set display information about the point type.

6. To collect the point, press .

2.8 Export Data

It is used to export measurement data file into your needed data format for later use.

See [3.6](#) Export File for details.

To export data, do the following:

1. Copy the data file that needs to import to SurPad folder.
2. Press main menu **Project** → **Export File**.
3. Select the target data file, enable whether to export road cross-section, file format, and angle format.
4. Press **Export**.
5. Select the target file storage (internal storage root directory or program storage directory).
6. **Optional:** Modify the file name.
The default one consists of the current data and time.
7. Press **Export** again.

A prompt *Export file succeeded* pops up.

3 Project

SurPad manages data in the form of engineering documents, that is, all operations are controlled in a project. Every time you start SurPad, the software will automatically invoke engineering documents used last time.

3.1 Project Manager

Press main menu **Project** → **Project Manager** to enter **Project Manager** interface:

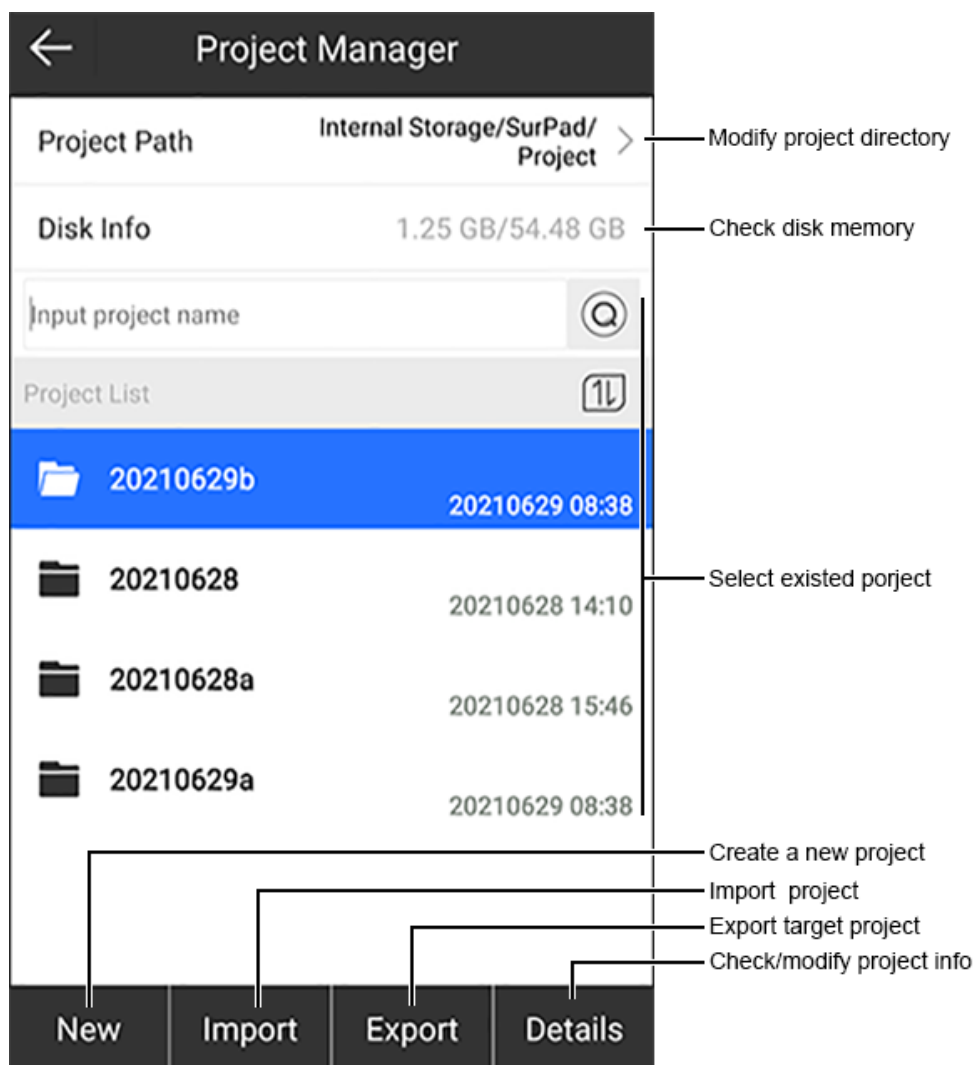

3.1.1 Modify the Project Directory

It is used to change the storage directory of the current project.

To modify the project directory, do the following:

1. Press **Project Path. File Directory** interface shows:

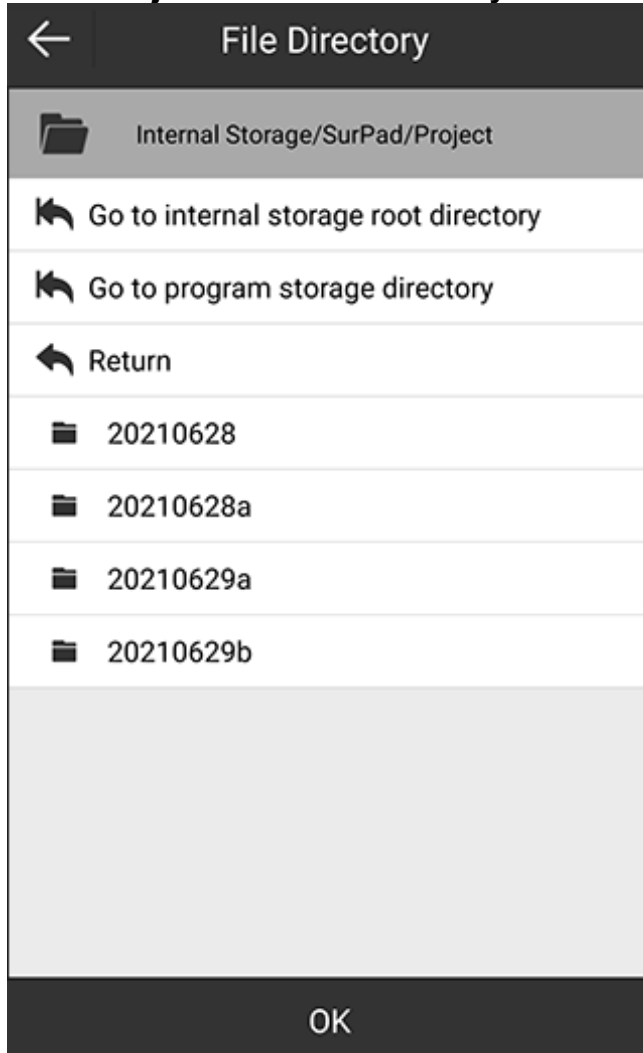

2. Select the target directory.



CAUTION: If the workload is large in survey, please make sure the memory of the target directory is sufficient to save the project.



3.1.2 Create a New Project

To create a new project, see [2.2 Create a New Project and Set Coordinate Parameters](#) for details.

3.1.3 Select a Existed Project

It is used to select a project as the current project if you have created projects before.

To select an existed project, do one of the following:

- To find a project in the local by its project name, input the project name, and press .
- To find a project in the local by the project list, in the **Project List** area, select a file folder.
If there are too many file folders, to quickly find the target one, you can press  and select a sorting method.
- To import a project in other directories, press **Import**, select the target file directory and project.

3.1.4 Export a Project

To export a project, do the following:

1. In the **Project List** area, select the target project.
2. Press **Export** and select the target file directory.

3.1.5 Check / Modify Project Information

To check / modify the project information, do the following:

1. Press **Details**. **Project Details** interface shows:

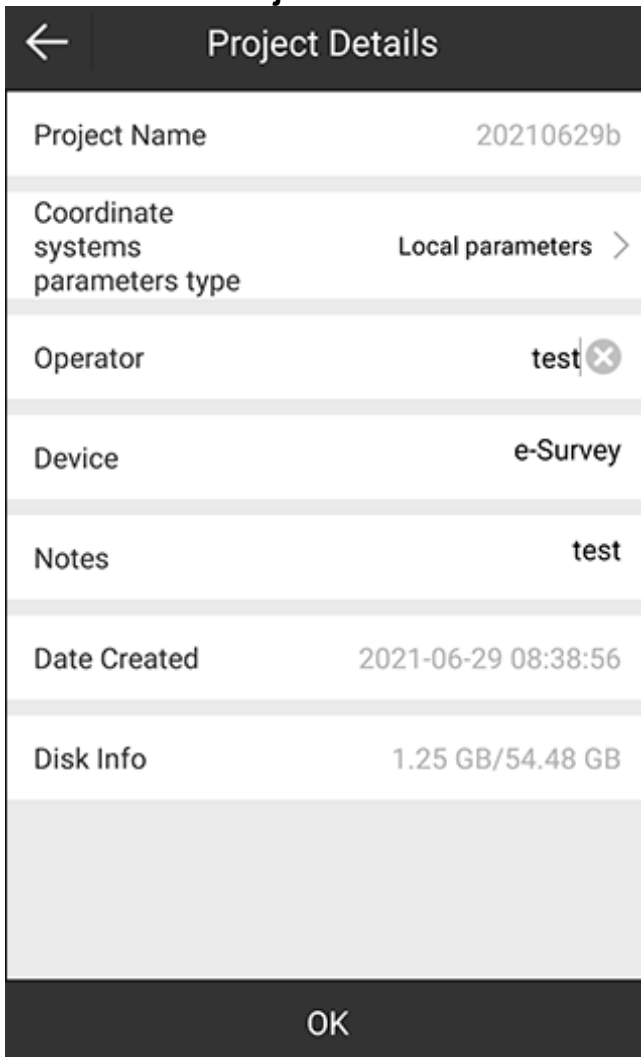

Project Details	
Project Name	20210629b
Coordinate systems parameters type	Local parameters >
Operator	test ✕
Device	e-Survey
Notes	test
Date Created	2021-06-29 08:38:56
Disk Info	1.25 GB/54.48 GB
OK	

2. **Optional:** Modify the following information based on your needs:
 - **Coordinate systems parameters type**
 - **Operator**
 - **Device**
 - **Notes**

3.2 Project Data Manager

It is used in a project where there is too much data or when you want to distinguish between two different coordinate point libraries.

Press main menu **Project** → **Project Data Manager** to enter **Project Data Manager** interface:

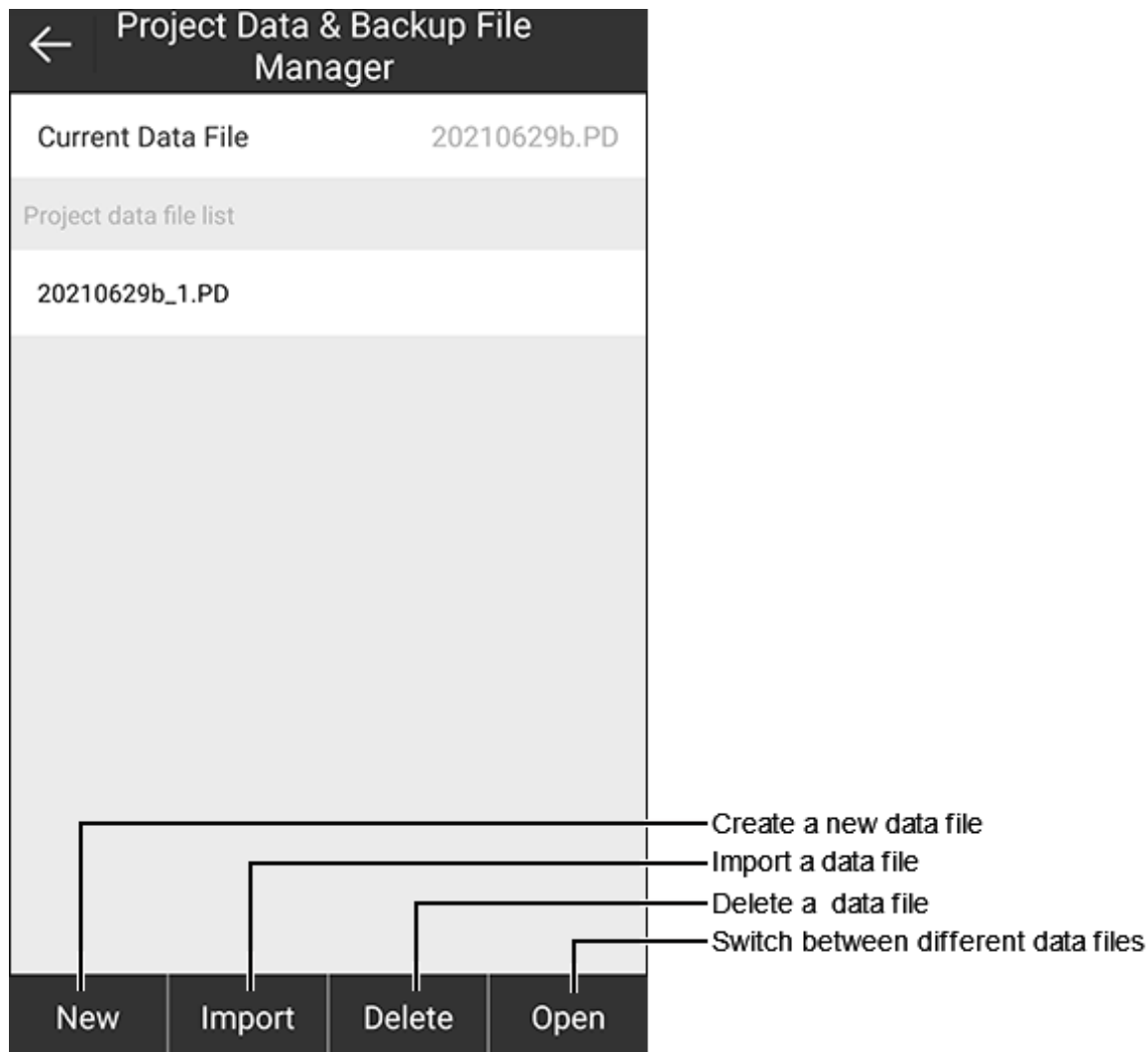

3.2.1 Create a New Data File

It is used to create a new data file with PD format to save the recorded survey data. The new data file is the data file for the storage record of the current project, and it belongs to the current project.

To create a new data file, do the following:

1. Press **New**. A prompt **Create new project data file** shows:

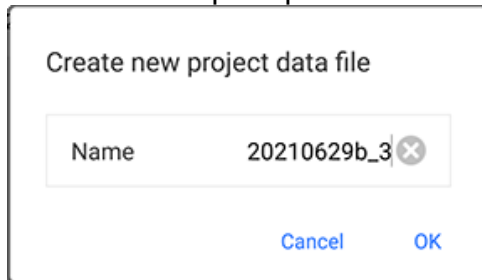

2. Set a name for the created data file.
Default: the current data file name_1/2/3... (accumulating)

3.2.2 Import a Data File

It is used to import a data file with RTK format.

To import a data file, do the following:

1. Select the target data file in **Project data file list** area.
2. Press **Import**. **Import Backup File** interface shows:

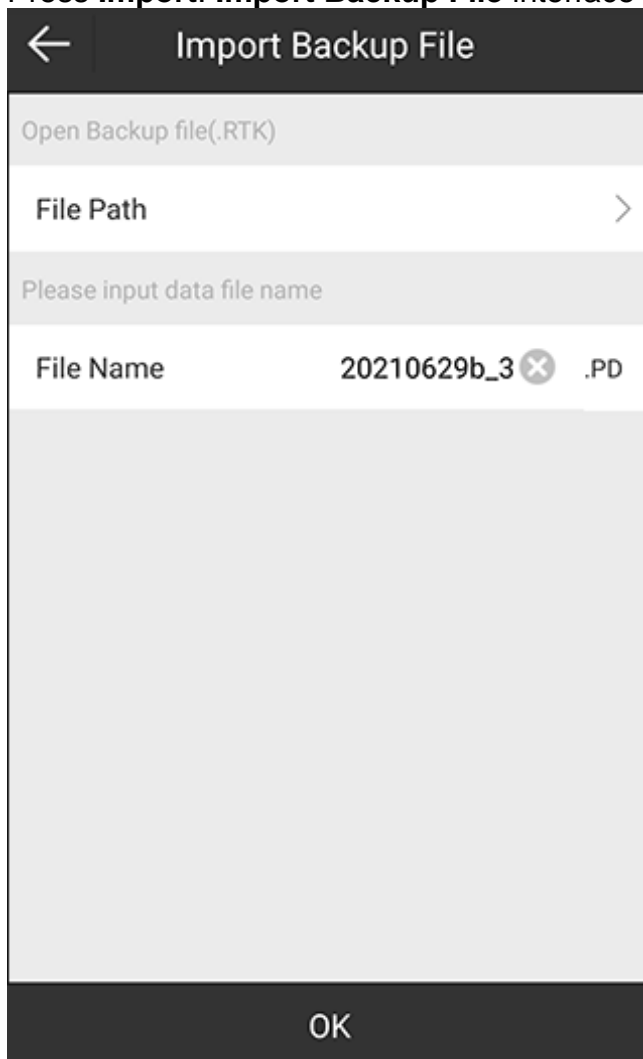

3. Press **File Path** and select the file path.
4. Set a name for the imported data file.

Default: the current data file name_1/2/3... (accumulating)

3.2.3 Delete a Data File

To delete a data file, do the following:

1. In **Project data file list** area, select the target file.
2. Press **Delete**. A prompt for confirmation shows.
3. Press **OK**.

3.2.4 Switch between Different Data Files

It is used to switch between different data files when a project owns multiple data files.

To switch between different data files, do the following:

1. In **Project data file list** area, select the target file.
2. Press **Open**.

3.3 Coordinate System

It is used to set coordinate system parameters.

Press main menu **Project** → **Coordinate System** to enter **Coordinate Systems Parameters** interface.

The interface differs in the coordinate system parameter type when a project is created:

- Local parameters
- RTCM1021~1027 parameters: a way to send coordinate system parameter via differential data. In this way, the software analyses coordinate parameters from received differential data.
The **Coordinate Systems Parameters** interface is unchangeable.
- CORS encrypted parameters: it is mainly used by CORS merchants when they would like to keep coordinate parameters secret.
The **Coordinate Systems Parameters** interface is unchangeable.

Taking parameter type **local parameters** as an example, the interface is as follows:

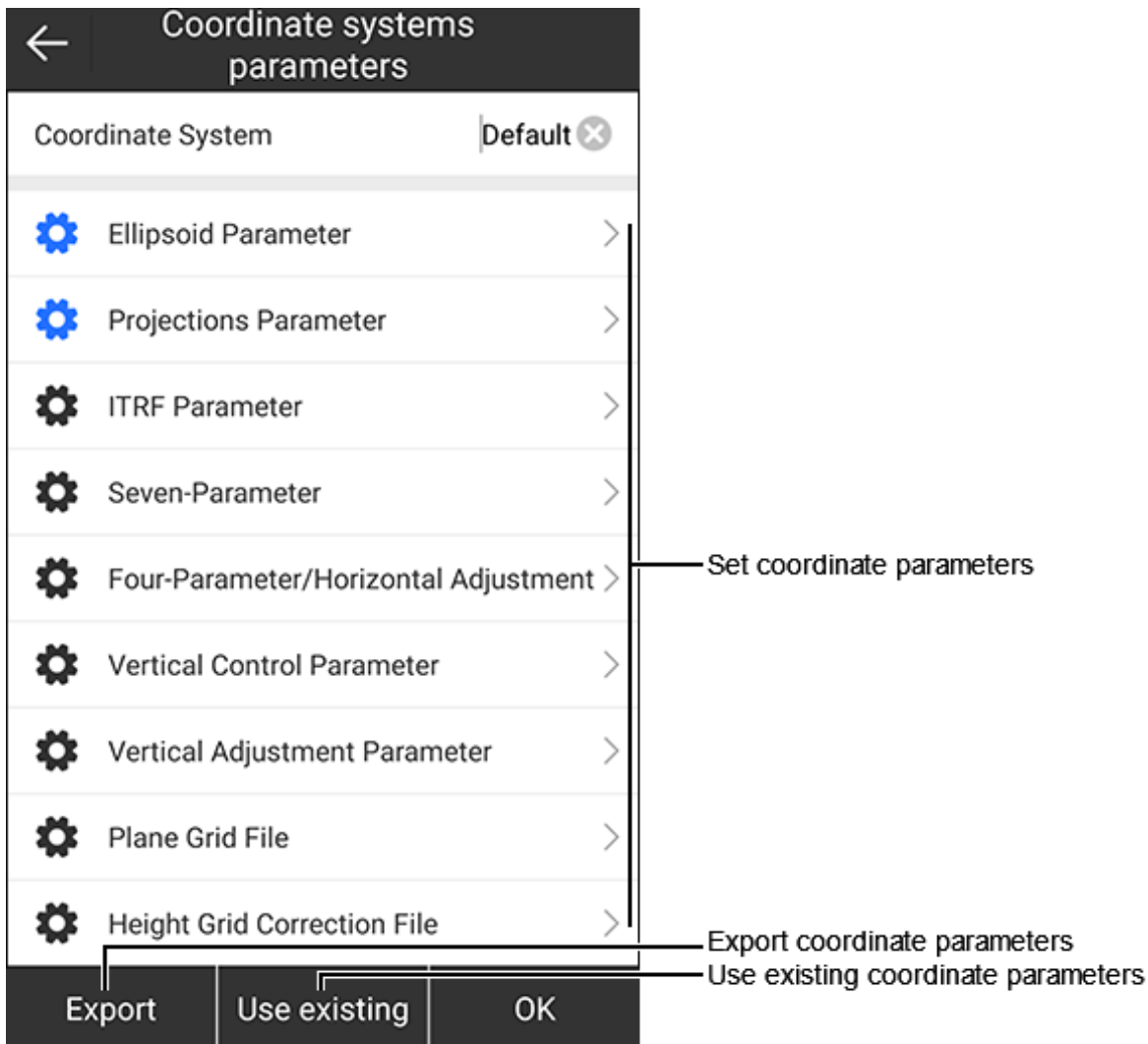

3.3.1 Set Coordinate Parameters

To set coordinate parameters, do the following:

1. Set a name for the coordinate system.
2. Set the following parameters according to the actual situation:
 - **Ellipsoid parameter:** to select the target ellipsoid or customize the ellipsoid. With the customized ellipsoid, please set the semimajor axis and reciprocal of flattening $1/f$, which should be the same with the ellipsoid used for parameter calculation.
 - **Projection parameter:** it contains most of the frequently-used projection modes, such as UTM, Gauss Kruger, Transverse Mercator, Lambert Conic Conformal, etc.
During setting projection parameters, when the central meridian is not the same with the actual situation, you can press  or manually input the current central meridian.
 - **ITRF parameter:** ITRF refers to International Terrestrial Reference Frame.
 - **Seven parameter:** to perform Space rectangular coordinate transformation within two different ellipsoids.

- **Four-parameter/horizontal adjustment:** in general at least two known points and four pairs of XY coordinate values in two different space rectangular coordinate systems are required to calculate the four unknown parameters.
- **Vertical control parameter:** to use some known points to calculate the vertical control parameters, in order to match the elevation of receivers with the local height system.
- **Vertical adjustment parameter:** the elevation transformation model of Trimble TGO software.
- **Grid file:** to match the horizontal difference (North and East) between the local and universal coordinate system, and import the grid file (*.GDS, *.GSB, *.GFS).
- **Geoid file:** to match the earth height (ellipsoid height used in GPS elevation system) with the normal height (used in elevation system in survey), and import the geoid file (*.GGF, *.SGF, *.UGF, *.GSF).
- **Local offsets:** to calculate local offsets based on a known point.

3.3.2 Use Existing Coordinate Parameters

It is used to apply coordinate system parameters stored before.

To use existing coordinate parameters, do the following:

1. Press **Use existing**.
2. Select one of the following methods to apply coordinate parameters:
 - **Local disk:** to apply them in the local. SP and EP formats are supported.
 - **QR code:** to apply them by scanning the QR code.
 - **Cloud server:** to apply them from the cloud server.
See [3.8](#) Cloud Settings for details.
 - **Predefined projections:** to apply predefined parameters saved before.

3.3.3 Export Coordinate Parameters

To export coordinate parameters, do the following:

1. Press **Export**.
2. Select one of the following methods to export the set coordinate parameters:
 - **Local Disk:** to save them in the SurPad files in the local.
 - **QR Code:** to save them as a QR code.
 - **Cloud Server:** to upload them to the cloud server.

3.4 Calibrate a Point

Press main menu **Project** → **Calibrate Point** to enter **Calibrate Point** interface:

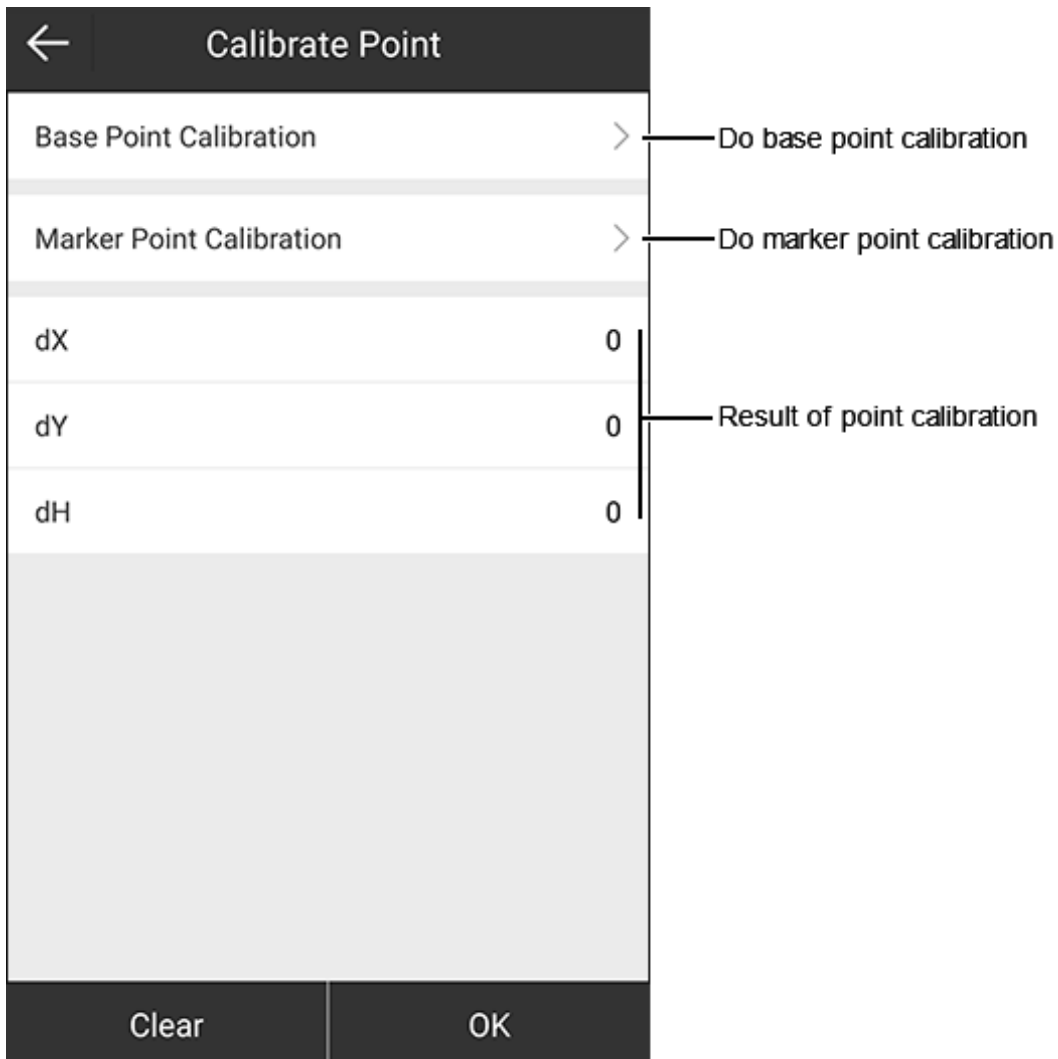

There are the following ways to calibrate a point:

- **Base point calibration:** the base station is set up at known control points and has been leveled and centered.



CAUTION: This function is rarely used in the measurement.

- **Marker point calibration:** the base station is not set up at a known control point when it has been turned on / off or its position has been changed, and the rover station is set up at known control points.

3.4.1 Do Base Point Calibration

By inputting coordinates of a known point and WGS84 coordinate automatically obtained when the base station is started, SurPad will calculate calibration parameters of the base station.

To do base point calibration, do the following:

1. To enter **Calibrate Point** interface, press main menu **Project** → **Calibrate Point**, and press **Base Point Calibration**:

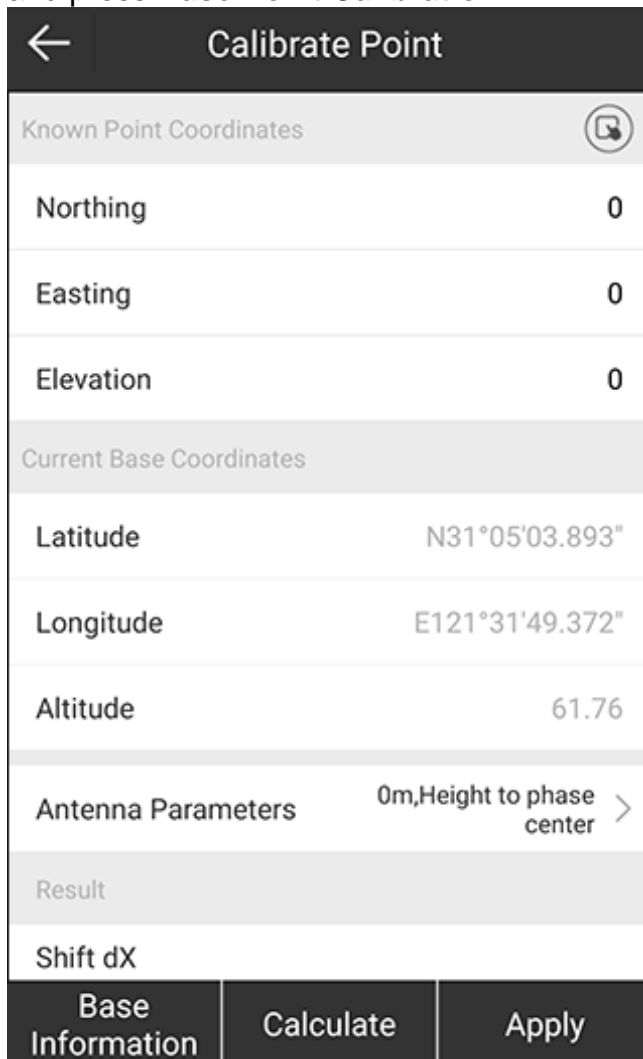

Known Point Coordinates	
Northing	0
Easting	0
Elevation	0
Current Base Coordinates	
Latitude	N31°05'03.893"
Longitude	E121°31'49.372"
Altitude	61.76
Antenna Parameters	0m, Height to phase center >
Result	
Shift dX	
Base Information	Calculate
Apply	

2. To input a known point, do one of the following:

- To select a point from the point database, press  and select the target point.
- To manually input coordinates, set values of **Northing**, **Easting** and **Elevation**.

3. To enter **Base Antenna Parameter** interface, press **Antenna Parameters**:

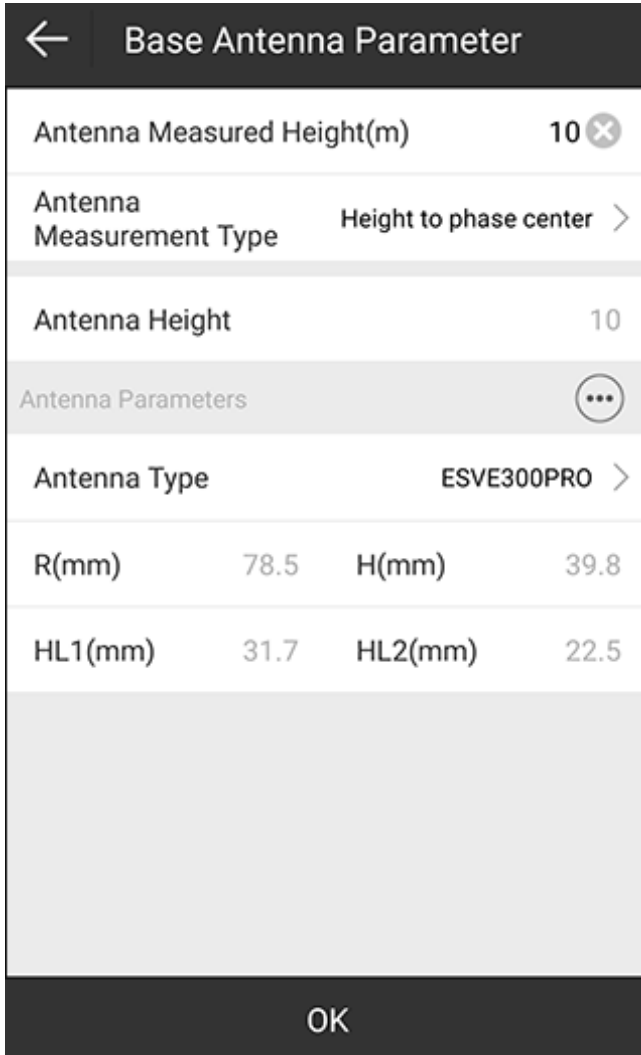

Base Antenna Parameter			
Antenna Measured Height(m)	10		
Antenna Measurement Type	Height to phase center		
Antenna Height	10		
Antenna Parameters	⋮		
Antenna Type	ESVE300PRO		
R(mm)	78.5	H(mm)	39.8
HL1(mm)	31.7	HL2(mm)	22.5
OK			

4. Set the following antenna parameters, and press **OK** to return to **Calibrate Point** interface:
- **Antenna Measured Height**
 - **Antenna Measured Type**: including pole height, height to phase center, slant height, slant height to altimetry.
 - **Antenna Type**: it is automatically set according to the current connected receiver.

5. To check the calculation result, press **Calculate**. The result is shown in **Result** area:

← Calibrate Point		
Known Point Coordinates 		
Northing	3441262.112	
Easting	359761.689	
Elevation	59.887	
Current Base Coordinates		
Latitude	N31°05'03.893"	
Longitude	E121°31'49.372"	
Altitude	51.76	
Antenna Parameters	10m, Height to phase center >	
Result		
Shift dX	0.001	
Base Information	Calculate	Apply

If the calculation result is in red font in **Result** area, it indicates the translation parameter is out of range (the longitude difference or latitude difference over 1°, or the height difference over 1000°).

6. To directly apply the calculation result, press **Apply**.

3.4.2 Do Marker Point Calibration

By inputting coordinates of a known point and the generated WGS84 coordinate, SurPad will calculate calibration parameters of the rover station.

To do marker point calibration, do the following:

1. To enter **Calibrate Point** interface, press main menu **Project** → **Calibrate Point**, and press **Marker Point Calibration**:

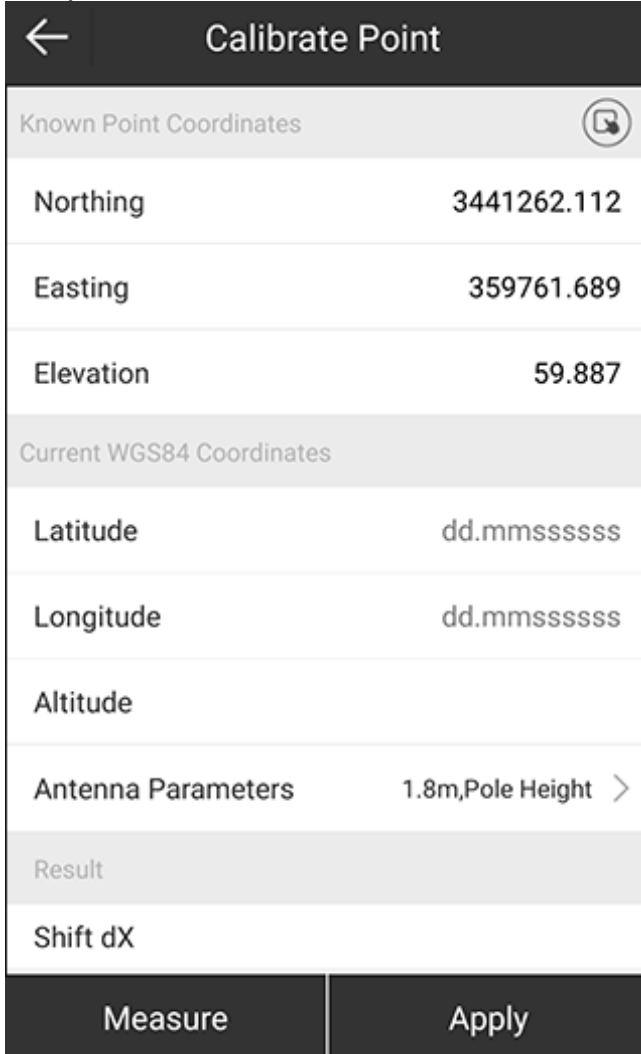

Known Point Coordinates	
Northing	3441262.112
Easting	359761.689
Elevation	59.887
Current WGS84 Coordinates	
Latitude	dd.mmssssss
Longitude	dd.mmssssss
Altitude	
Antenna Parameters	1.8m, Pole Height >
Result	
Shift dX	

2. To input a known point, do one of the following:
 - To select a point from the point database, press  and select the target point.
 - To manually input coordinates, set values of **Northing**, **Easting** and **Elevation**.

3. Press **Measure. Record Point** interface shows:

Record point			
Antenna Parameters	1.8m,Pole Height >		
Name	Pt6 <input type="text"/>		
Code	<input type="text"/>		
Progress	<1/1>Collected		
Solution Status	<35/47>FIXED		
HRMS	0.005		
VRMS	0.01		
Northing	3441262.111		
Easting	359761.69		
Elevation	59.887		
Latitude	N31°05'03.893"		
Longitude	E121°31'49.3721"		
Settings	Restart	Save&Apply	OK

4. Set a name and code.

- To set saved conditions, press **Setting**, and set related parameters in **Saved Conditions** interface, and press **OK** to return to **Record point** interface:

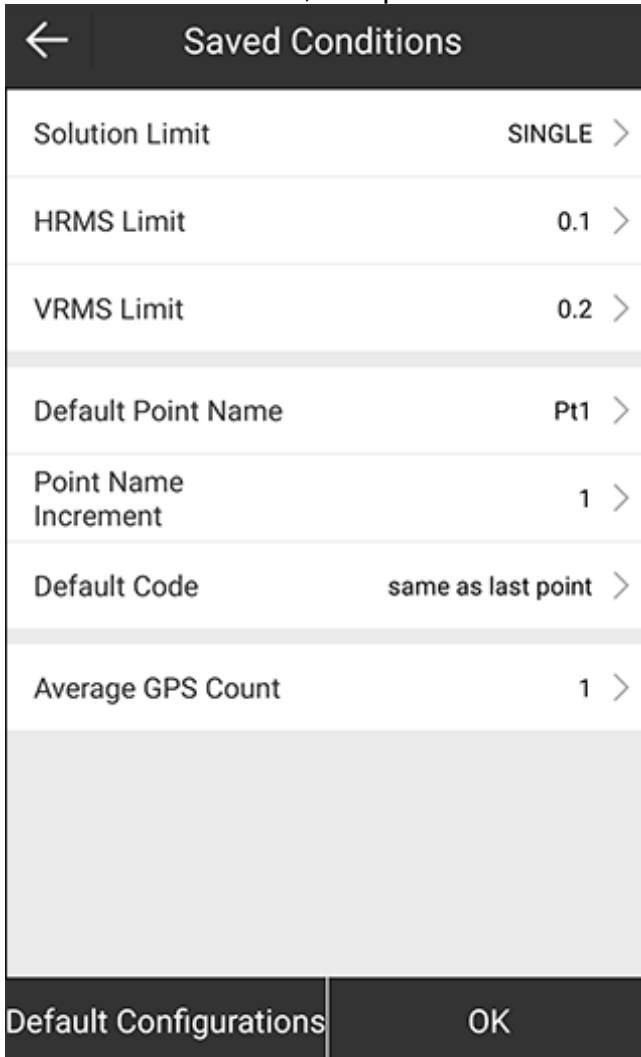

Saved Conditions	
Solution Limit	SINGLE >
HRMS Limit	0.1 >
VRMS Limit	0.2 >
<hr/>	
Default Point Name	Pt1 >
Point Name Increment	1 >
Default Code	same as last point >
<hr/>	
Average GPS Count	1 >
<hr/>	
Default Configurations	OK

- Press **Antenna Parameters**, and set antenna parameters.
- Press **OK** to return to **Calibrate Point** interface. The result shows in **Result** area.
- To directly apply the calculation result, press **Apply**.

3.5 Point Database

It is used to manage all types of coordinate points.

Press main menu **Project** → **Points Database** to enter **Points Database** interface:

The screenshot shows the 'Points Database' interface. At the top, there is a search bar with the text 'Count 5' and 'Input name or code'. Below the search bar is a table with columns: Name, Northing, Easting, Elevation, and Lat. The table contains five rows of data for points Pt1 through Pt5. At the bottom, there is a navigation bar with buttons: Add, Edit, Details, Import, and ...

Callouts from the right side of the image point to various features:

- Find a existed point (points to the search icon)
- Directly select a point (points to the point icons in the table)
- Add a new point (points to the 'Add' button)
- Edit a point (points to the 'Edit' button)
- Check point info (points to the 'Details' button)
- Import a point (points to the 'Import' button)
- Do the following:
 - Delete a point
 - Filter points
 - Recover points
 - Share a point

3.5.1 Find the Existed Point

To find the existed point, do the following:

1. Input a name or a code of the existed point in input box of **Count n**.
2. Press .

3.5.2 Add a New Point

To add a new point, do the following:

1. Press **Add. New Point** interface shows:

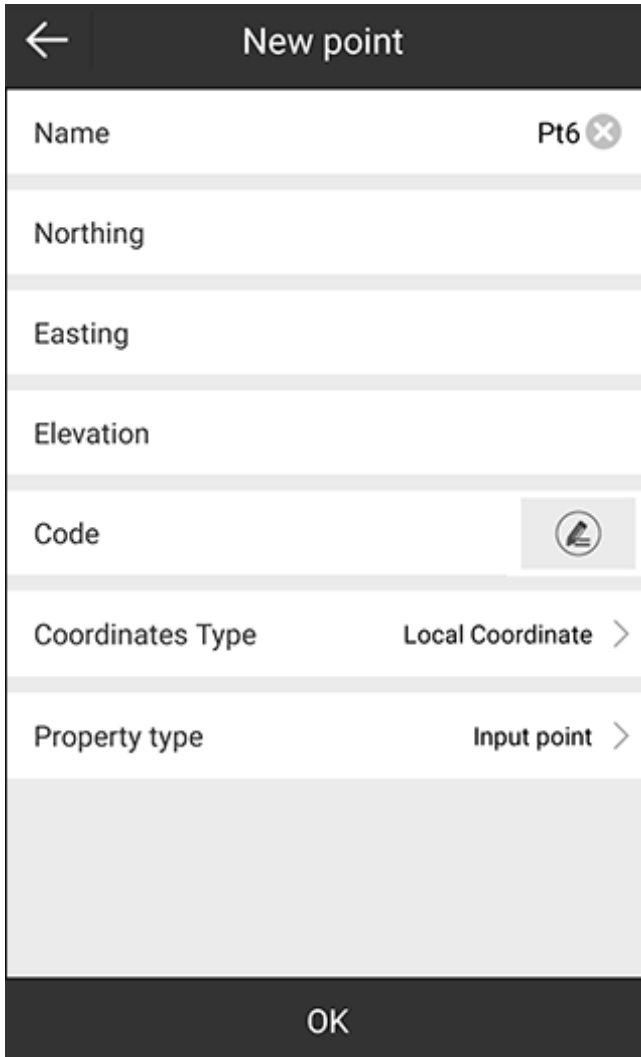

2. Input a name.
3. Select a coordinate type:
 - **Local Coordinate**
 - **Geodetic Coordinate**
4. Set one of the following coordinates:
 - If the coordinate type is set to **Local Coordinate**, set northing, easting and elevation.
 - If the coordinate type is set to **Geodetic Coordinate**, set latitude, longitude and altitude.

5. To set a code, do one of the following:

- Directly input a code name.

- To select a code from the code database manager, press :

← Code Library Manager			
No.	Name	Full Path	
1	a1	Internal Storage/SurPad/Config/a1.txt	
2	a2	Internal Storage/SurPad/Config/a2.txt	
3	a3	Internal Storage/SurPad/Config/a3.txt	

New	Edit	Delete	Import	OK
-----	------	--------	--------	----

6. Select a property type:

- **Assistant point**
- **Control point**
- **Input point**
- **Stakeout point**

3.5.3 Edit a Point

To edit a point, do the following:

1. Select a point.
2. Press **Edit**. **Edit Point** interface shows:

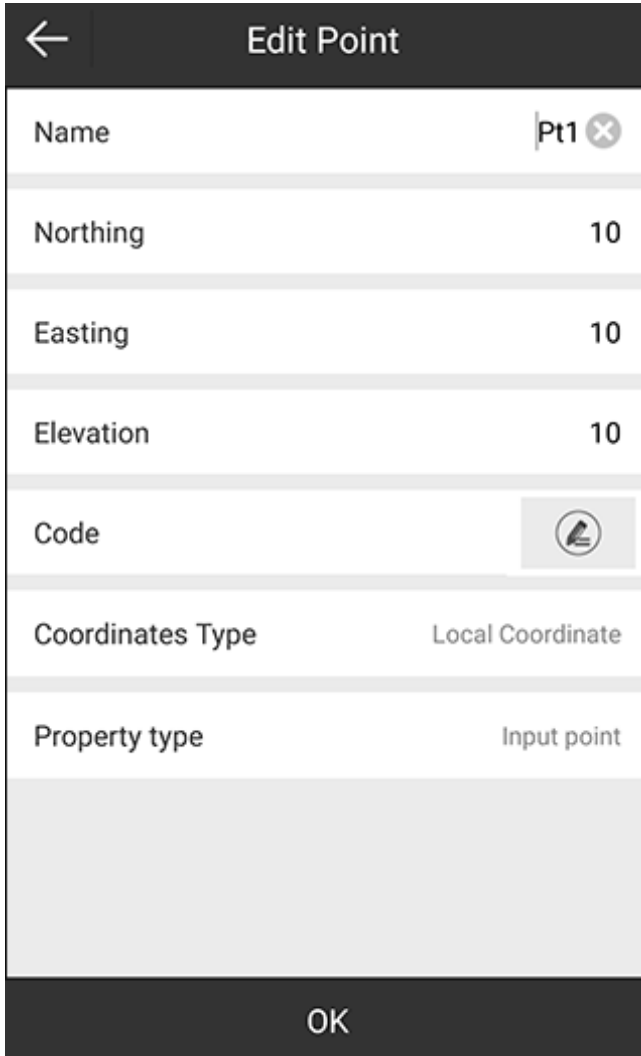

Edit Point	
Name	Pt1 <input type="text"/>
Northing	10
Easting	10
Elevation	10
Code	<input type="text"/>
Coordinates Type	Local Coordinate
Property type	Input point
OK	

3. Modify the following based on your needs:
 - **Name**
 - **Coordinate**: including northing, easting and elevation. It is only for input points. For measured points, this is unavailable.
 - **Code**

3.5.4 Check Point Information

It is used to check the point name, code, latitude, longitude, altitude, northing, easting, elevation, coordinates of X, Y and Z, and property type.

To check point information, do the following:

1. Select a point.
2. Press **Details**. **Point Details** interface shows:

← Point Details	
Title	Content
Point Name	Pt4
Code	
Latitude	N31°05'03.893"
Longitude	E121°31'49.372"
Altitude	59.899
Northing	3441262.11
Easting	359761.689
Elevation	59.899
X	-2859084.051
Y	4660052.802
Z	3273943.182

Photo And Sketch

3.5.5 Import a Point

To import a point, do the following:

1. Press **Import**. **Import File** interface shows:

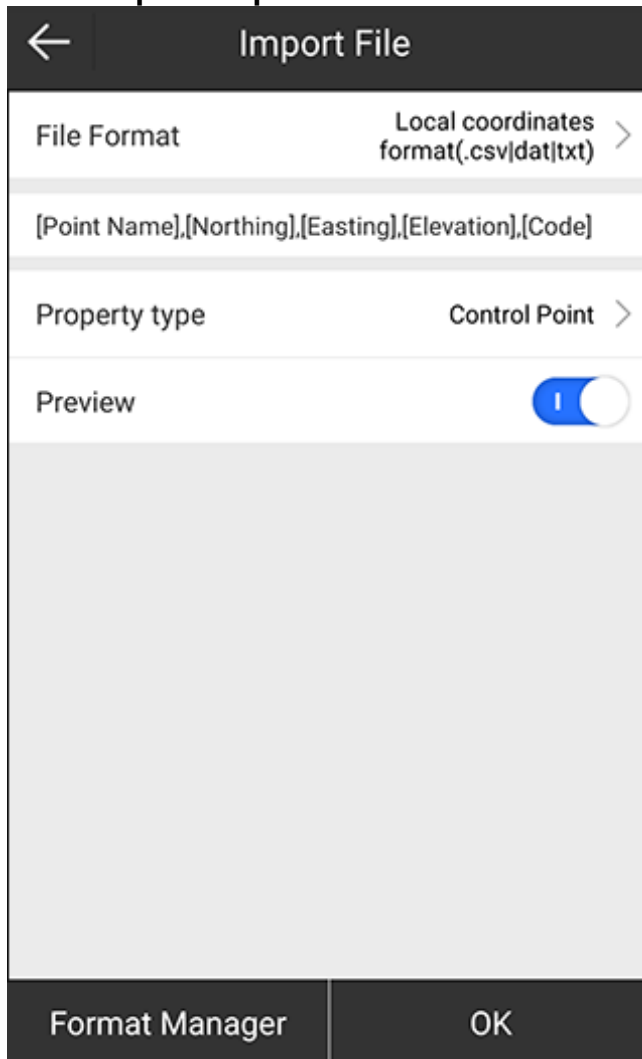

2. **Optional:** To add a user-defined format, do the following:
- Press **Format Manager**:

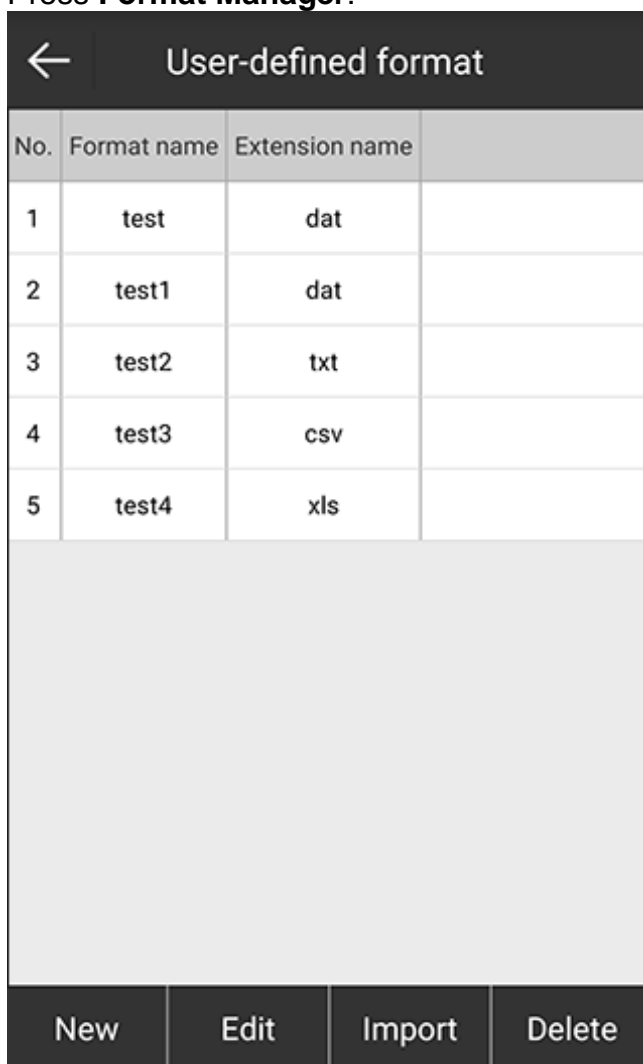

No.	Format name	Extension name	
1	test	dat	
2	test1	dat	
3	test2	txt	
4	test3	csv	
5	test4	xls	

New Edit Import Delete

b. Press **New**:

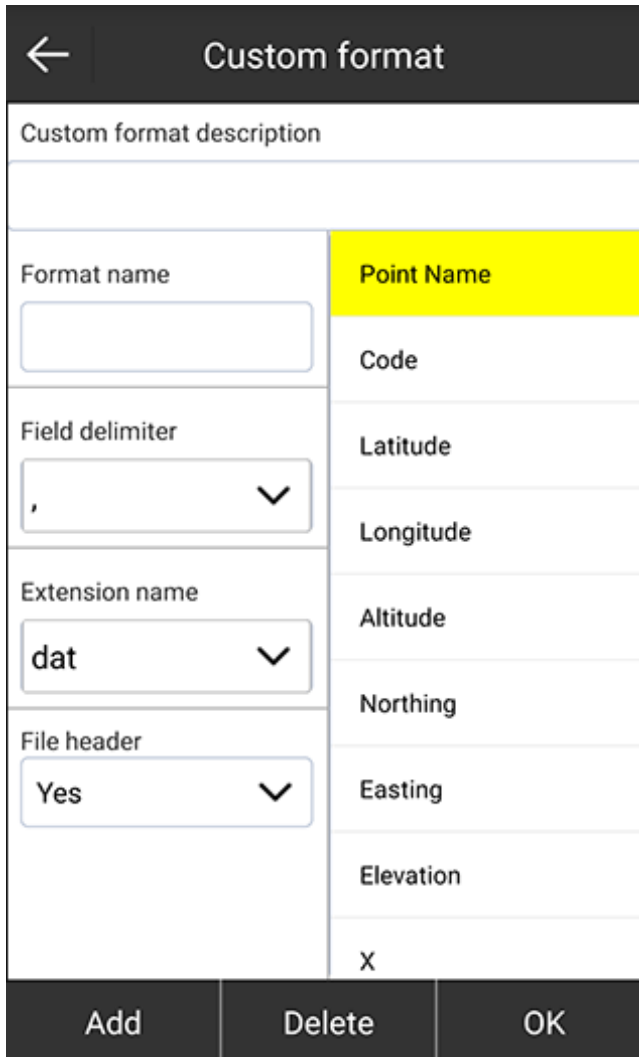

c. Set format name, field delimiter, extension name and add format description.

d. Press **OK**. The add user-defined format shows in the existed file formats.

3. Press **File Format**, and select one of the following existed file formats:

- Measurement data file (.PD): preview is not supported.
- Geodetic coordinates format (.csv / .dat / .txt)
- Local coordinates format (.csv / .dat / .txt)
- COT format (.cot)
- Cass format (.dat)
- AutoCAD format (.dxf)
- GoogleEarth kmz file format (.kmz)
- NETCAD format (.ncn)
- PXY file (.pxy)
- Carlson coordinate file (.crd)
- Spatial coordinate (.csv / .dat / .txt)
- User-defined formats

4. Select a property type.

5. **Optional**: To preview the point, enable **Preview**.

6. Press **OK**.

7. Select the target file directory and the target file.

8. Preview the data, and press **OK** to import coordinates if the data is correct.

3.5.6 Delete a Point

To delete a point, one of the following:

1. Do one of the following:
 - Long press the target point in **Points Database**.
 - Press ... → **Delete**.

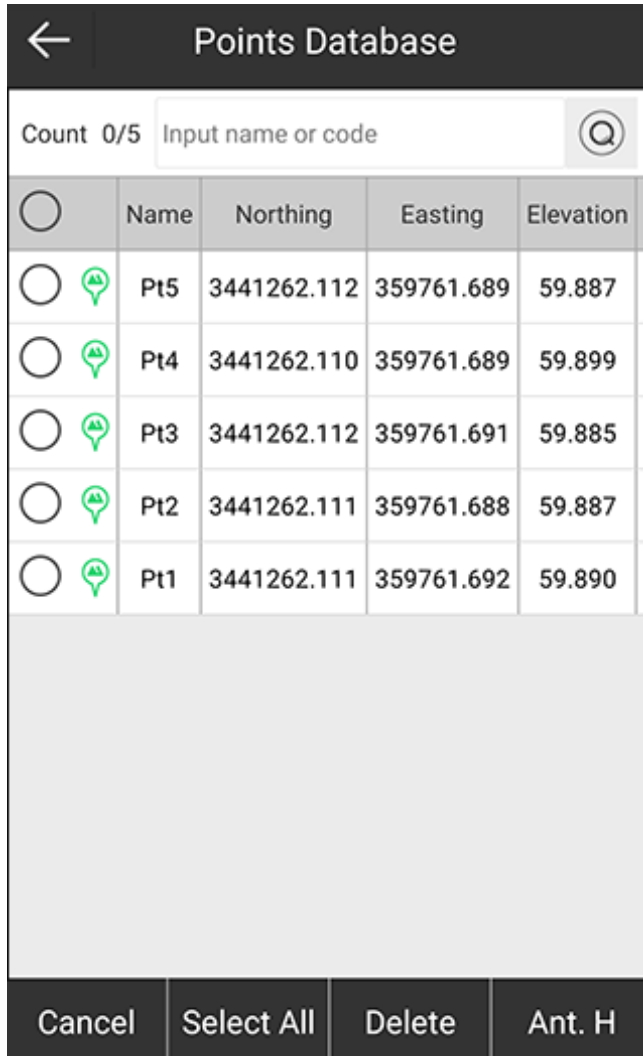

2. To select the target point, do one of the following:
 - Input the name or code of the target point, and press .
 - To select the target point in the point list, check it.

3.5.7 Filter Points

To filter points, do the following:

1. Press ... → **Options**. The **Filter Operation** interface shows:

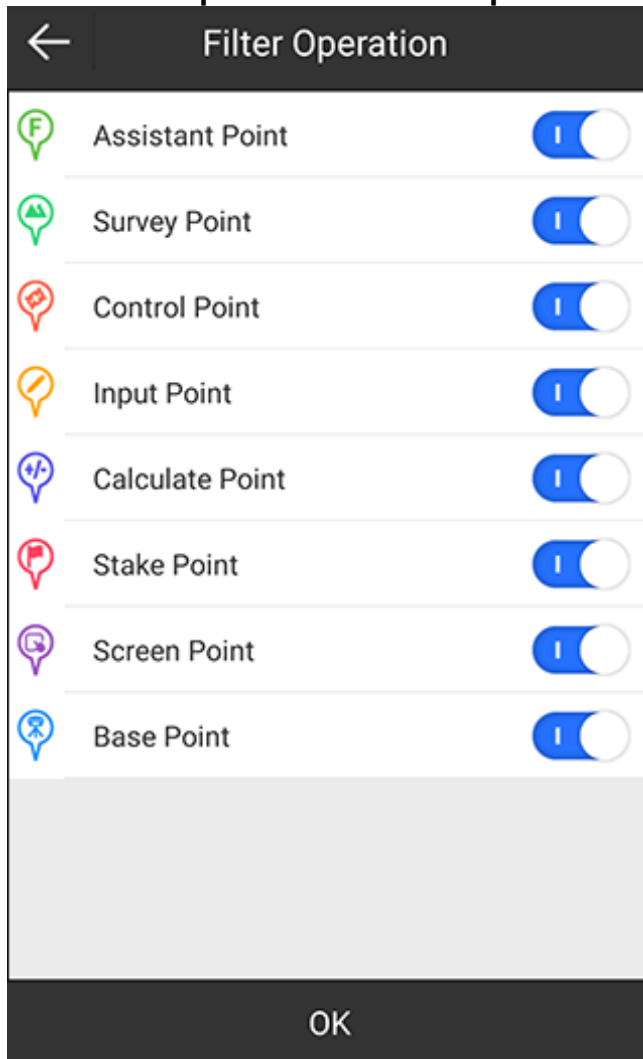

2. Enable or disable the target point type.

3.5.8 Recover Points

It is used to recover points you deleted.

To recover points, do the following:

1. Press ... → **Recover**. The **Deleted Points** interface shows:

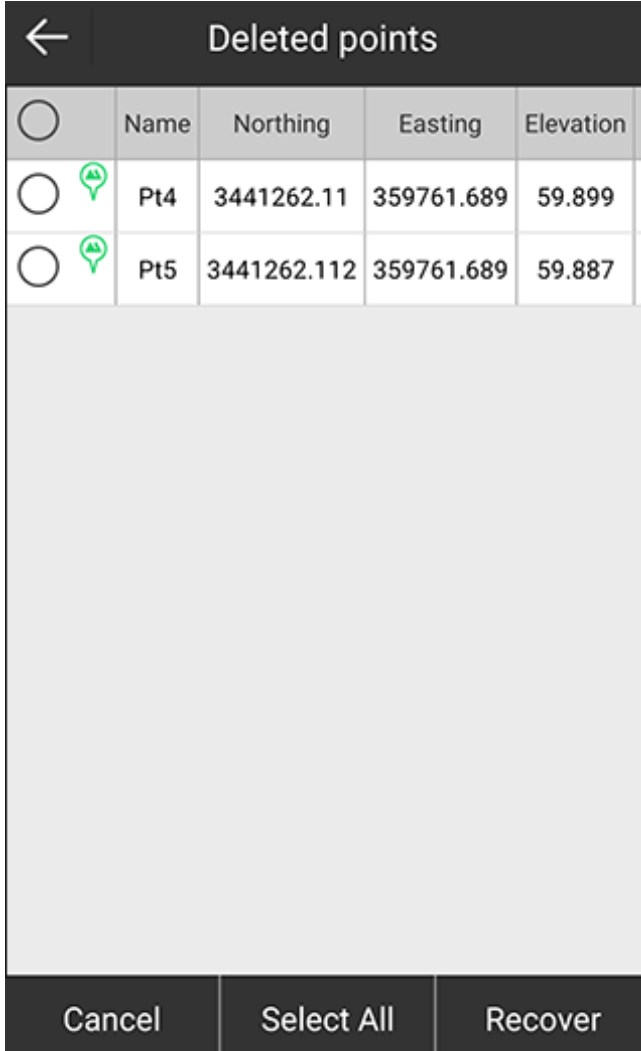

	Name	Northing	Easting	Elevation
<input type="radio"/>	Pt4	3441262.11	359761.689	59.899
<input type="radio"/>	Pt5	3441262.112	359761.689	59.887

Buttons: Cancel, Select All, Recover

2. Do one of the following:
 - Check the target point(s).
 - To select all points, press **Select All**.
3. Press **Recover**.

The target point(s) show(s) in **Point Database** interface again.

3.5.9 Share a Point

To share a point, do the following:

1. Select the target point in **Points Database** interface.
2. Press ... → **Share**. A QR code of the target point is automatically generated:

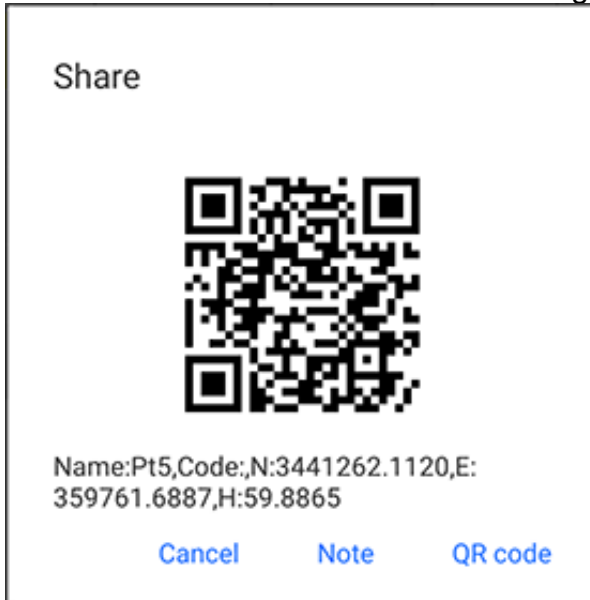

3. Press **QR Code**, and select the target app on your device.

3.5.10 Modify Antenna Parameters

It is used to modify antenna parameters of points except screen points, so as to adjust the coordinates of points.

To modify antenna parameters, do the following:

1. Long press the target point in **Points Database** interface:

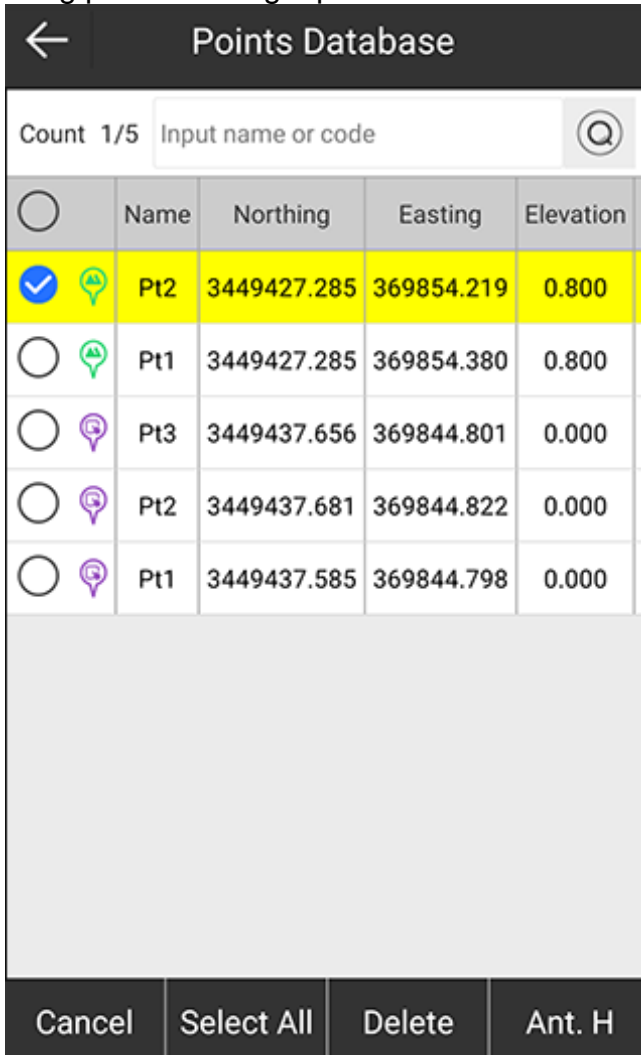

<input type="radio"/>	Name	Northing	Easting	Elevation
<input checked="" type="radio"/>	Pt2	3449427.285	369854.219	0.800
<input type="radio"/>	Pt1	3449427.285	369854.380	0.800
<input type="radio"/>	Pt3	3449437.656	369844.801	0.000
<input type="radio"/>	Pt2	3449437.681	369844.822	0.000
<input type="radio"/>	Pt1	3449437.585	369844.798	0.000

At the bottom of the interface, there are four buttons: Cancel, Select All, Delete, and Ant. H.

2. **Optional:** Check all target points.
3. Press **Ant.H. Antenna Parameters** interface shows.
4. Set antenna measure height and antenna measurement type.

3.6 Export File

It is used to export measurement data file into the data format that you need.

Press main menu **Project** → **Export File** to enter **Export File** interface:

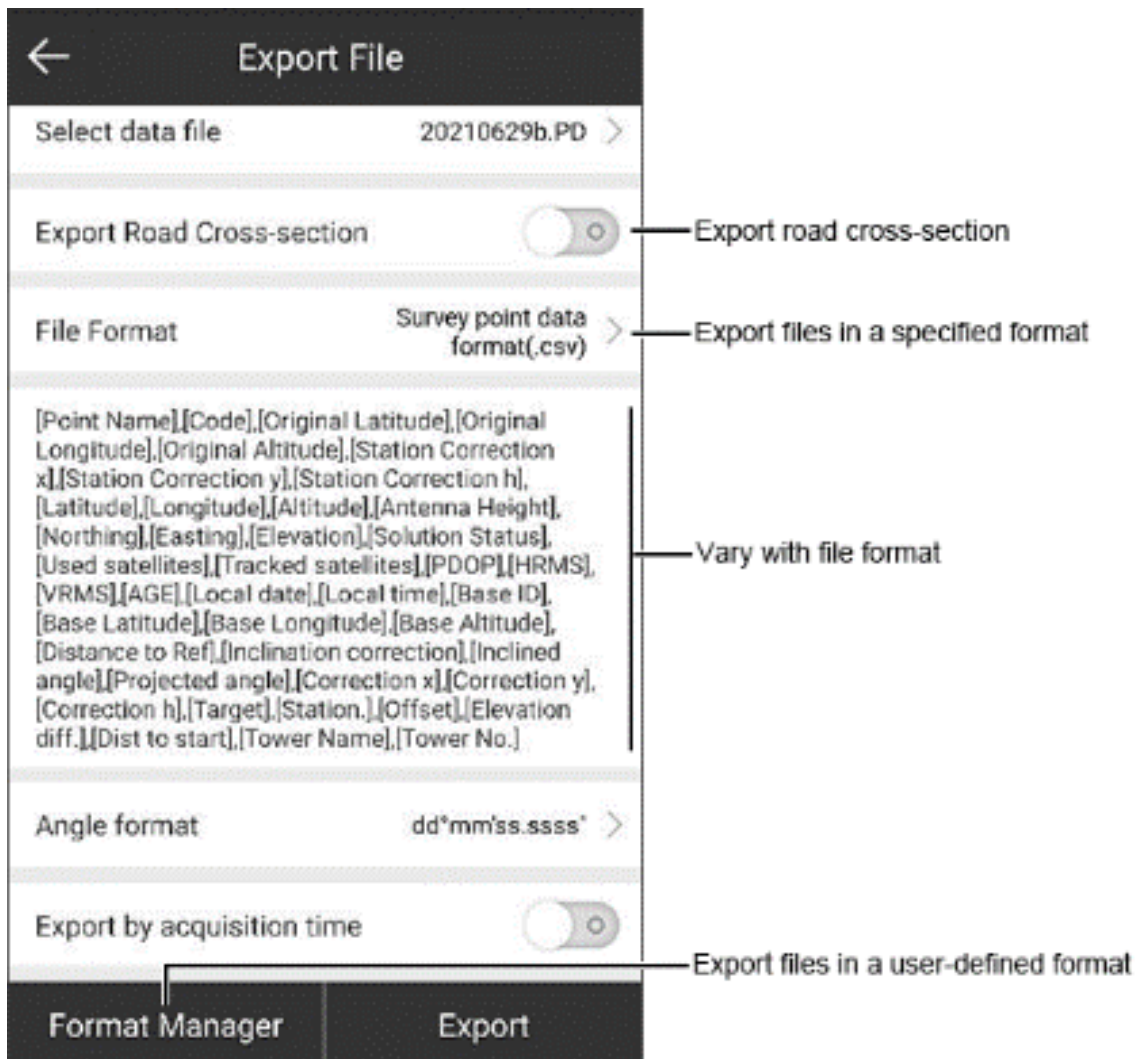

3.6.1 Export a File in a Specified Format

To export files in a specified format, do the following:

1. Select a data file.
2. Select one of the following file formats:
 - Survey point data format (.csv)
 - Survey point data format (.xls)
 - TPS Survey point data format (.csv)
 - Cass format (.dat)
 - KS Scsg2000 (.dat)
 - Local coordinates format (.dat)
 - Geodetic coordinates format (.dat)
 - Name, North, East, Elevation, Station, Offset (.dat)
 - AutoCAD format (.dxf)
 - GoogleEarth kml file format (.kml)
 - GoogleEarth kmz file format (.kmz)

- SW electric file format (.swd)
- Track file format (.gpx)
- DOL file format (.csv)
- DOL file format (.html)
- LSS file format (.001)
- Photo and Skethc (.jpg)
- NETCAD format (.ncn)
- PXY file (.pxy)
- Carlson coordinate file (.crd)
- Cadastral surveying data format (.PD)
- GNSS Survey Report (.xls)

3. Press **Export**.

3.6.2 Export a File in a User-defined Format

To export a file in a user-defined format, do the following:

1. Press **Format Manager**. **User-defined format** interface shows:

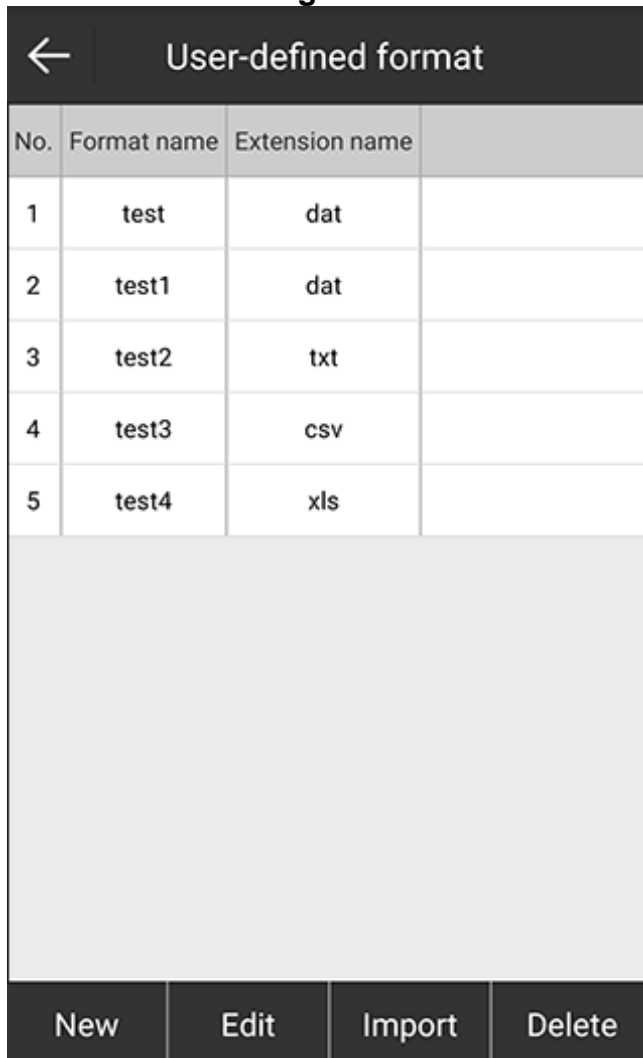

No.	Format name	Extension name	
1	test	dat	
2	test1	dat	
3	test2	txt	
4	test3	csv	
5	test4	xls	

New
Edit
Import
Delete

- **New**: to create a new customized file format.
- **Edit**: to edit the created file format.
- **Import**: to import a customized file format.
- **Delete**: to delete the created customized file format.

2. Press **New**. **Custom format** interface shows:

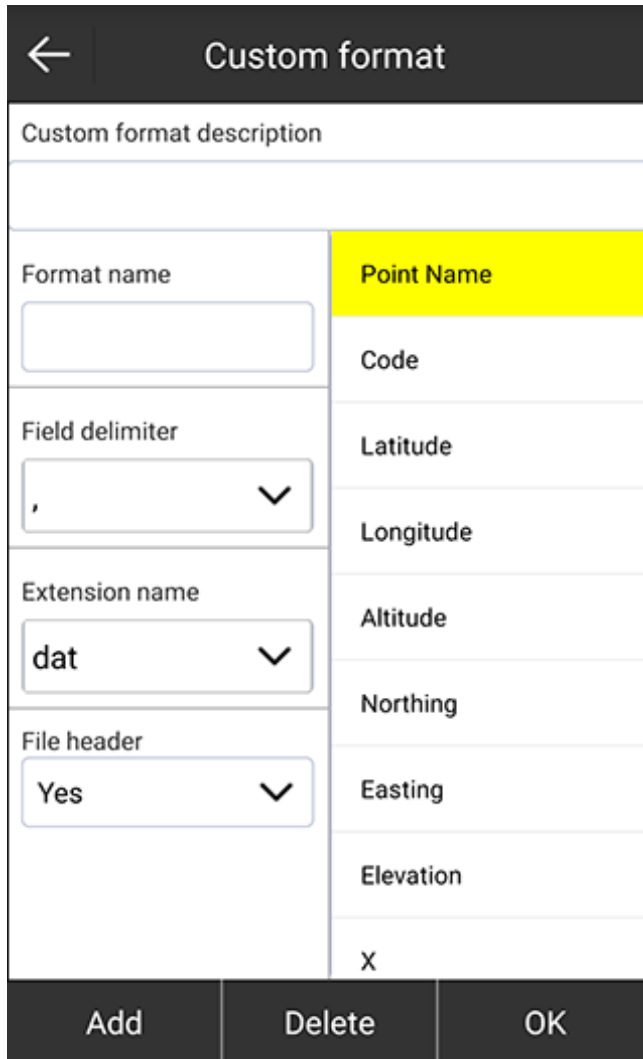

3. Set the following:

- Format name
- Field delimiter: , @ Space Tab Enter
- Extension name: dat, csv, txt, xls
- File header

4. Select the exported format content, and press **Add** to add the content to the input box of **Custom format description**.

5. **Optional:** To delete the content of the custom format description one by one, press **Delete**.

6. Press **OK**. The interface returns to **User-defined format**.

7. Go back to **Export File** interface, and select a data file.

8. Select the customized file format.

9. Press **Export**.

3.6.3 Export Road Cross-section

To export road cross-section, do the following:

1. Enable **Export Road Cross-section**. The following interface shows:

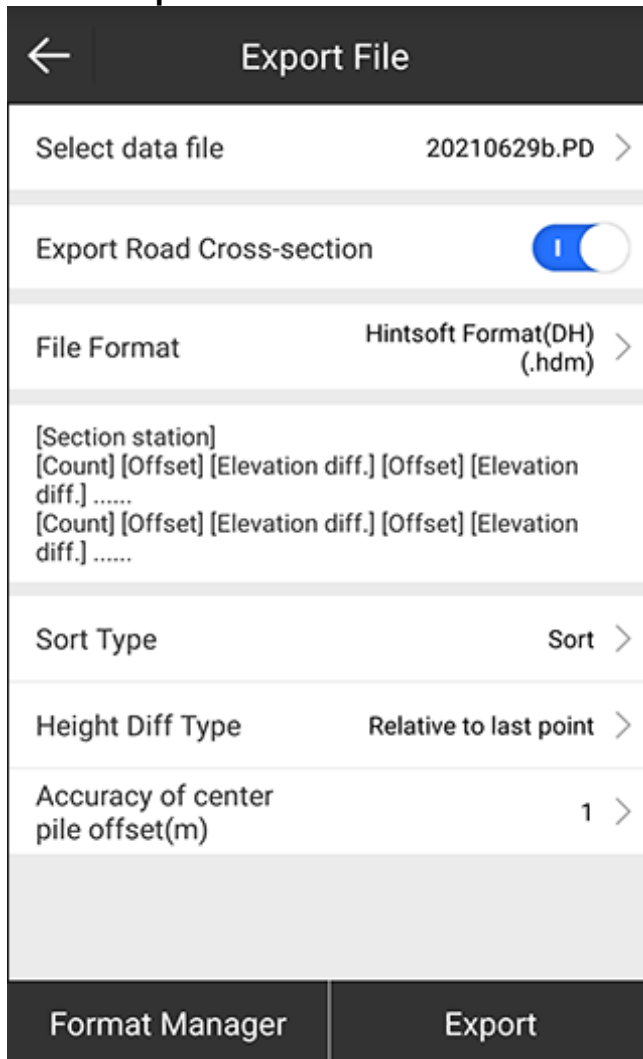

The interface varies with the file format.

2. Select a data file.
3. Select a file format:
 - Hintsoft format (DH)(.hdm)
 - TianZhen format (H) (.hdm)
 - SOUTH CASS Cross-section file format (.hdm)
 - Haiti (.hdm)
 - Section measurement data (.csv)
4. Do related settings.
5. Press **Export**.

3.7 Scan QR Code

It is mainly used to scan the QR code of coordinate system and configuration set. Press main menu **Project** → **Scan QR Code** to enter **Scan QR Code** interface:



After scanning the QR code, you can view detail information and apply the data in the current project.

3.8 Cloud Settings

It is a customized function. Please contact us if necessary.

Press main menu **Project** → **Cloud Settings**, and turn **Use** switch to **ON** status to enter **Cloud Settings** interface:

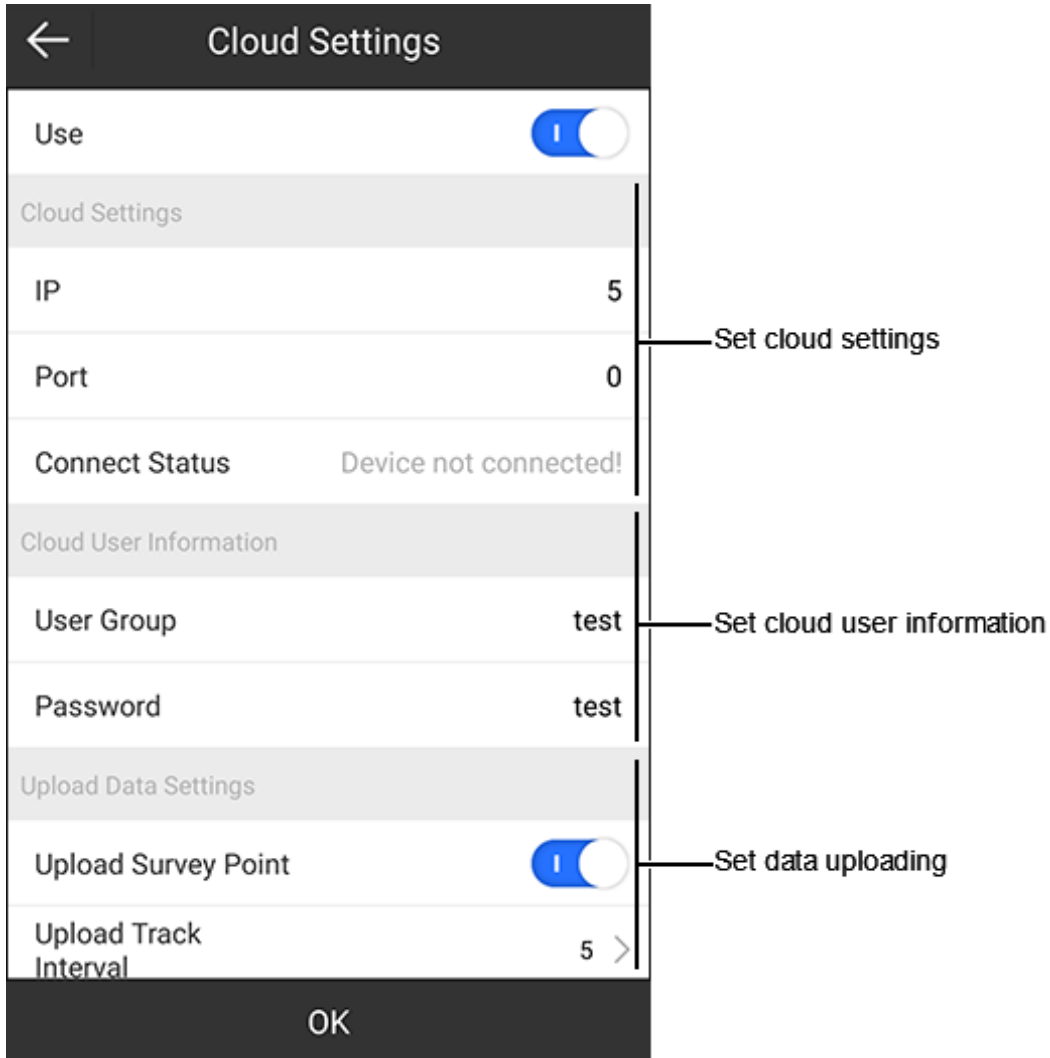

You can use existing coordinate parameters through cloud server by pressing main menu **Project** → **Coordinate System**.

3.9 Software Settings

It is used to set the following:

- General settings: including shortcuts, software update notification, and voice prompt.
- Record settings: including topo point, control point, quick point, auto point, corner point, stop & go point, and tilt point.
- System settings: including distance unit, distance decimal, angle format, angle decimal, station format, language, text encoding, survey point data backup, change alert of base coordinates, location services, and auto start at boot.
- Display settings: including CAD background color, display content, coordinate order habit, display type, last (0 ~ 100) points, screen orientation, full screen display, and map display.

To do software settings, press main menu **Project** → **Software Settings** to enter **Software Settings** interface, and modify related settings based on your needs.

3.10 About Software

It is used to check feedback, activate the software and check the latest version.

Press main menu **Project** → **About Software** to enter **About Software** interface:

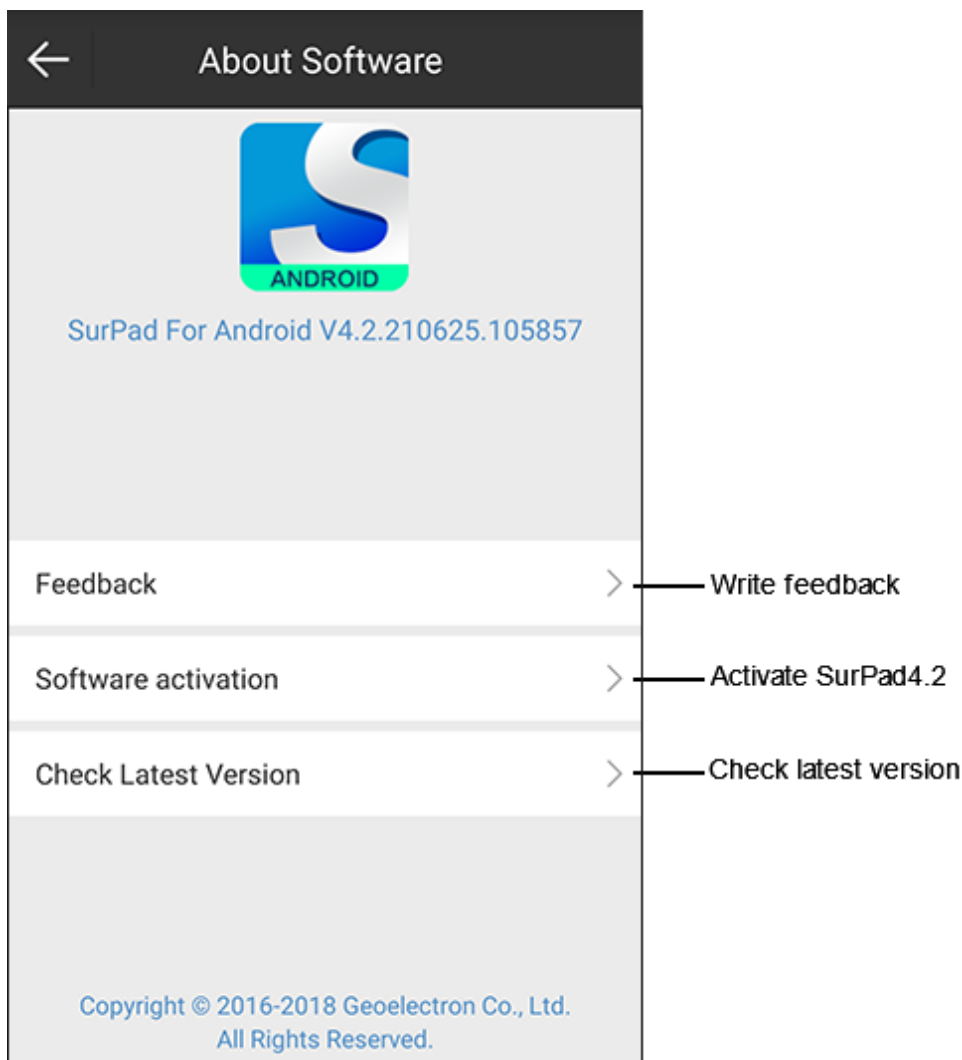

3.10.1 Write Feedback

To write feedback, do the following:

1. Press **Feedback**. **Feedback** interface shows:

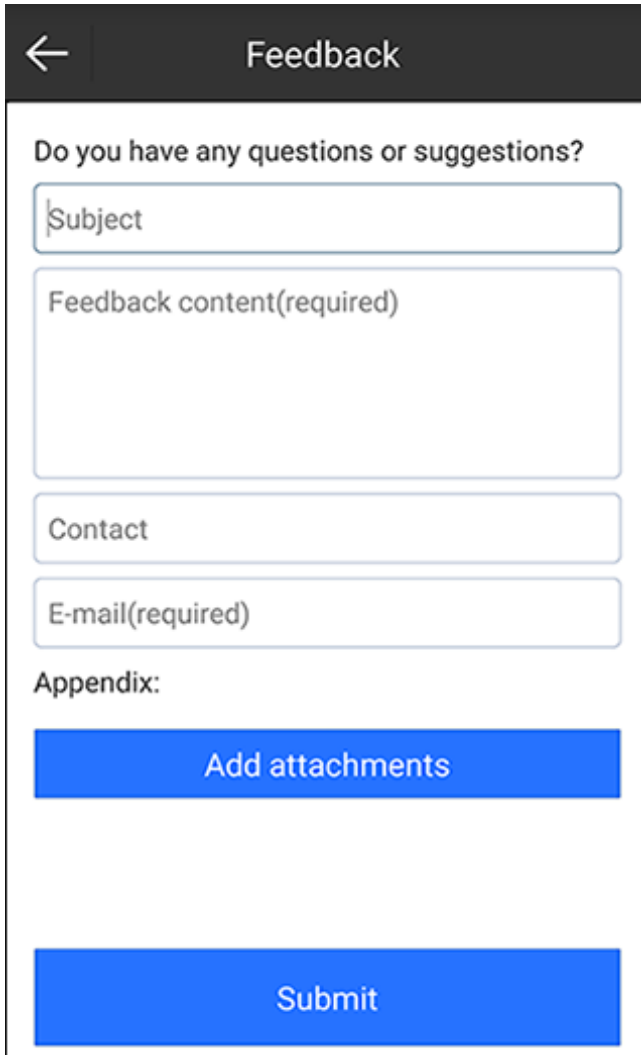

2. Write your feedback.
Attachments are available.
3. Press **Submit**.

3.10.2 Activate the SurPad

See [2.1.2](#) Activate the SurPad for details.

3.10.3 Check the Latest Version

It is used to check if the current software is the latest version.

To check the latest version, press **Check Latest Version**:

- If it is the latest version, the interface shows **Latest version**.
- If not, a prompt *New version found. Update now?* shows to remind you to update the software.

4 Device

4.1 Communication

Press main menu **Device** → **Communication** to enter **Communication** interface:

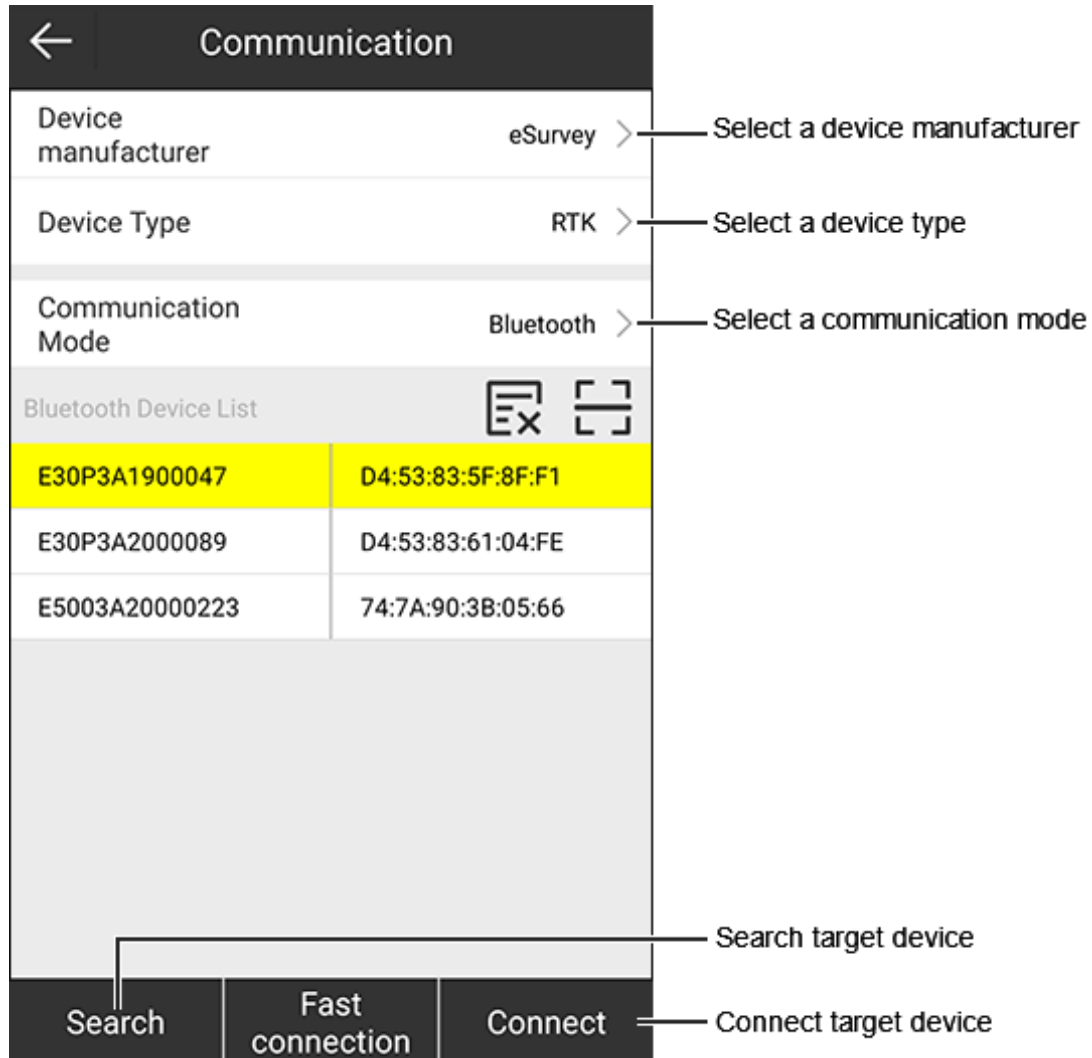

The device type differs in the device manufacturer. Connection to a total station is supported.

See [2.3](#) Connect to the Receiver for details.

4.2 Rover

It is used to set the receiver as the rover station.

Press main menu **Device** → **Rover** to enter **Rover mode settings** interface:

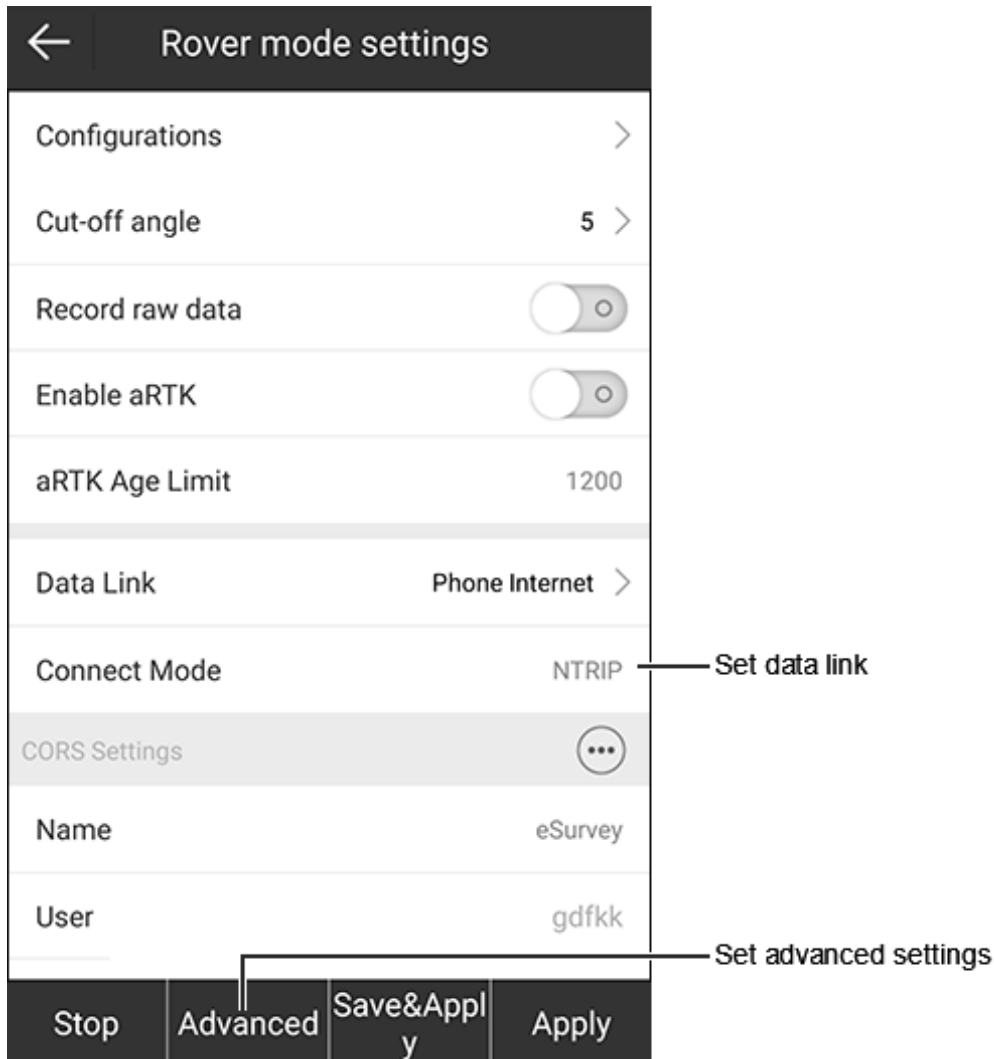



- **Cut-off angle:** the minimum vertical angle that is allowed to receive satellite signals. Signals below the angle will be ignored.
- **Record raw data:** to select whether to record raw data. With raw data recorded, you can set point name and collect post-differential point.
- **Enable aRTK:** to select whether to enable aRTK. With it enabled, the receiver is able to generate RTK positions even if the RTK correction source becomes unavailable within the set aRTK age limit.
- **Data link:** to select a way to transmit differential signals:
 - **None:** no differential signals is transmitted.
 - **Device Internet:** through the internal network in the receiver via a SIM card.
 - **External Radio:** through an external radio connected with the receiver.
 - **Phone Internet:** through the network of the used device.
 - **Internal Radio:** through the internal radio.

4.2.1 Set the Data Link

It is used to set the current data link.

To set the data link, do one of the following:

- If the data link is set to **Device Internet**, set the following:
 - In **Connect Mode** area, set the following:
 - **Connect mode**
 - **NTRIP**: the standard network transmission differential mode, commonly used in CORS networks.
 - **CSD**: the original form of data transmission developed for the time-division multiple access (TDMA)-based mobile phone systems.
 - **TCP client**: one of the main protocols of the Internet protocol suite. It can be used to transfer differential data.
 - **Custom**: the user defined mode.
 - **GGA upload interval (s)**: default value: 5.
 - **Auto connect to network**: to select whether the receiver automatically connects to the internet once it is powered on.
 - **Network mode**: including GPRS and WIFI (the receiver should equip with WIFI function).
 - **Network system**: including auto, GSM, and CDMA1x.
 - **Network relay**: to select whether to use network relay.
 - In **APN Settings** area, select whether to automatically connect to APN, or set operator, name, user and password.
 In addition, you can press  after **APN Settings** to add an APN.
 - In **CORS Settings** area, set name, user and password.
 In addition, you can press  after **CORS Settings** to customize information about the CORS server.
 - In **MountPoint Settings** area, set mount point, select whether to enable phone internet access, and press **Get Mount Point**.
- If the data link is set to **External Radio**, set baud rate.
 Default baud rate: 38400
- If the data link is set to **Phone Internet**, set the following:
 - In **CORS Settings** area, set name, user and password.
 In addition, you can press  after CORS Settings to customize information about the CORS server.
 - In **MountPoint Settings** area, set mount point, and press **Get Access Point**.
 - In **Receive Data** area, select whether the receiver automatically connects to the internet once it is powered on.
- If the data link is set to **Internal Radio**, set the following:
 - **Channel and frequency**: channel 1~7 is fixed whose frequency is unchangeable; channel 8 is user-defined whose frequency can be set as needed.



CAUTION: With this data link, the frequency and protocol settings of the rover and base should be the same.

- **Protocol:** including Satel, PCC-4FSK, PCC-GMSK, TrimTalk 450S, HiTarget(9600), HiTarget(19200), South 9600, Trimmari III, South 19200, TrimTalk(4800), PCC-GMSK(4800), GEOTALK, GEOMARK, etc.

4.2.2 Set Advanced Settings

To set advanced settings, do the following:

1. Press **Advanced. Advanced Settings** interface shows:

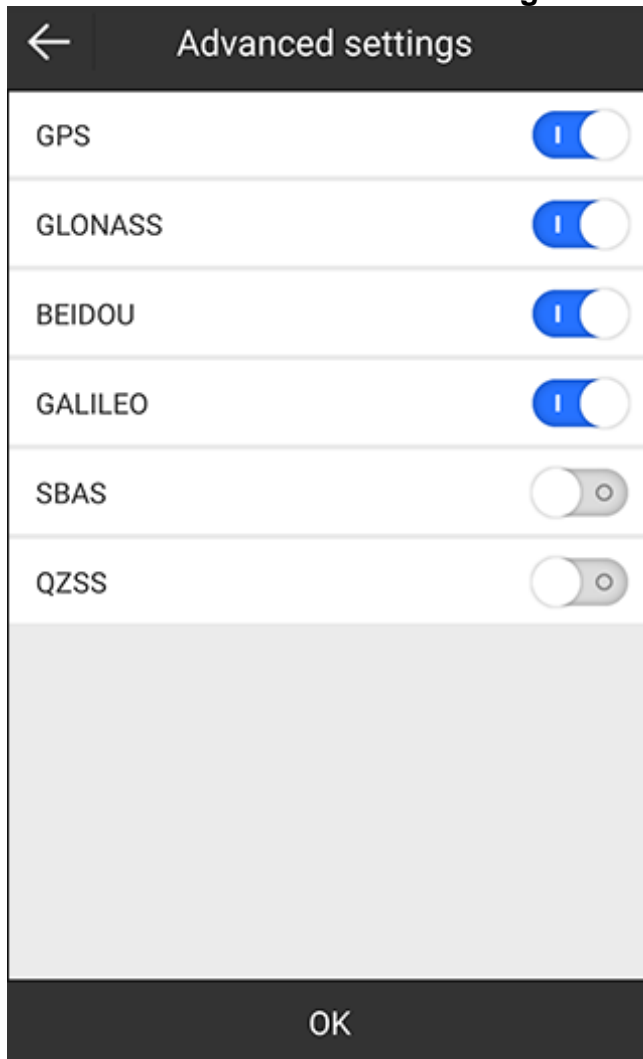

2. Select whether to receive signals from the following systems:
 - **GPS**
 - **GLONASS**
 - **BEIDOU**
 - **GALILEO**
 - **SBAS:** the wide-area differential augmentation system (satellite-based augmentation system).
 - **QZSS**

4.3 Base

It is used to set the receiver as the base station.

Press main menu **Device** → **Base** to enter **Base mode settings** interface:

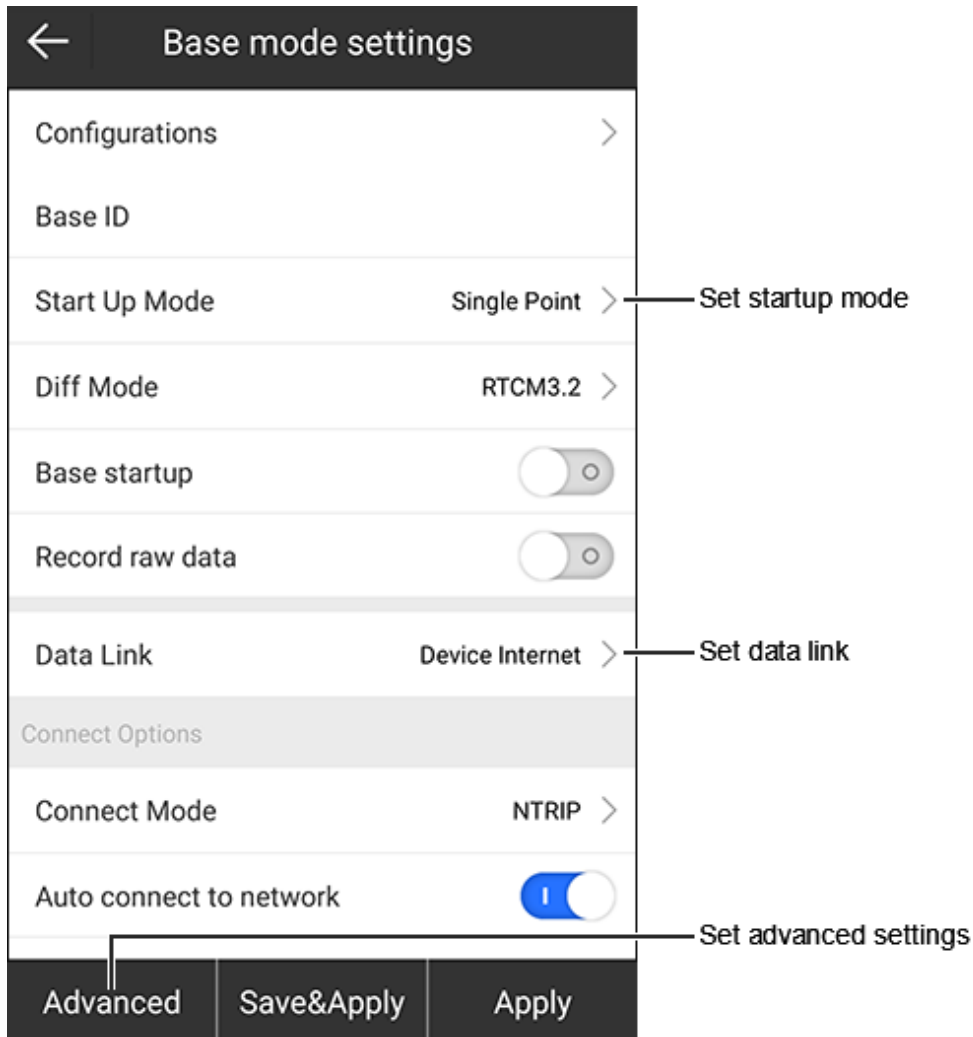

CAUTION: If the receiver is not in the base mode, you can directly modify its base parameters and set the receiver as the base station; if it is, you need to stop the base station before modifying its base parameters.

- **Base ID:** ID of the base station.
- **Startup mode:** including single point and input base coordinates.
- **Diff mode:** including RTCM3, CMR, CMR+, DGPS and RTCM32.
- **Base startup:** to select whether the base station automatically sends data after it is restarted.
- **Record raw data:** to select whether to record raw data.
With raw data recorded, you can set point name and collect post-differential point.
- **Data link:** to select a way to transmit differential signals:
 - **Device internet:** through the internal network via a SIM card or WIFI.
 - **External radio:** through an external radio connected with the receiver.
 - **Internal radio:** through the internal radio.
 - **Dual:** through the device internet and external radio.

4.3.1 Set the Startup Mode

The supported startup modes include the following:

- **Single point:** to directly use WGS-84 coordinates of the current point as the base coordinates.
In this mode, point calibration for the rover station is required. See [3.4 Calibrate a Point](#) for details.
- **Input base coordinates:** to manually input the base coordinates.





CAUTION: If the current position differs significantly from the input coordinates, please check the coordinate system or use single point mode to start base.

To set the startup mode by inputting base coordinates, do the following:

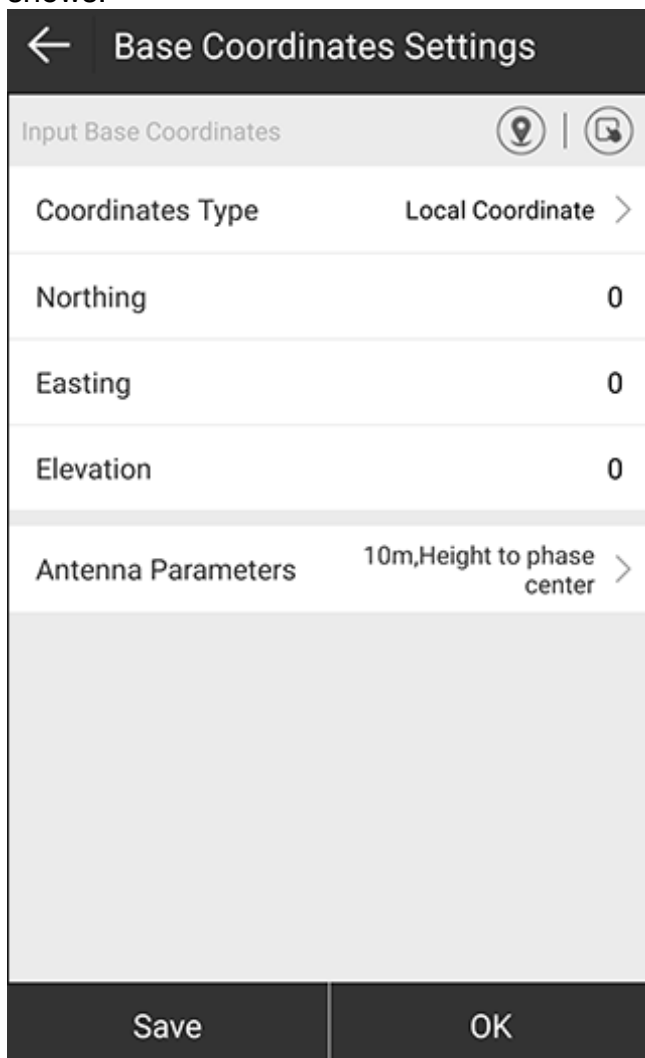
1. Select **Start up mode as Input base coordinates. Base Coordinates Settings** shows:



Base Coordinates Settings	
Input Base Coordinates	
Coordinates Type	Local Coordinate >
Northing	0
Easting	0
Elevation	0
Antenna Parameters	10m, Height to phase center >
<div style="display: flex; justify-content: space-around;"> Save OK </div>	

2. To get the base coordinates, do one of the following:
 - To use the current GPS coordinates, press .
 - To select a point from the point database, press  and select the target point.
 - To manually input coordinates, select a coordinate type (geodetic coordinate or local coordinate), and set values of base coordinate.
3. To get antenna height, press **Antenna Parameters**, and set antenna measured height and antenna measurement type in **Base Antenna Parameter** interface:

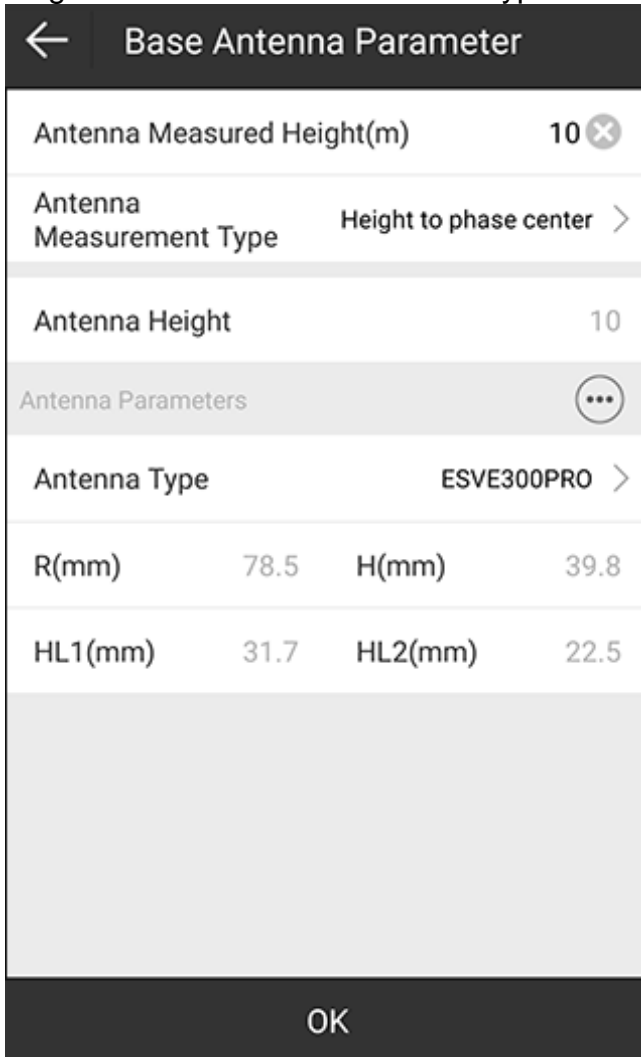



The antenna type will be automatically recognized.

4. **Optional:** To save coordinates to the point database, press **Save** in **Base Coordinates Settings** interface.
5. To apply the base coordinate settings, press **OK**.

4.3.2 Set the Data Link

It is used to set the current data link.

To set the data link, do one of the following:

- If the data link is set to **Device internet**, set the following:
 - In **Connect options** area, set the following :
 - **Connect mode**
 - **NTRIP**: the standard network transmission differential mode, commonly used in CORS networks.
 - **Custom**: the user defined mode.
 - **ZHD**: the differential transmission mode of HI-TARGET network, which needs to set group number and subgroup number.
 - **CHC**: the differential transmission mode of CHC network.
 - **Auto connect to network**: to set whether the receiver automatically connects to the internet once it is powered on.
 - **Network mode**: including GPRS and WIFI (the receiver should equip with WIFI function).
 - **Network system**: including auto, GSM, and CDMA1x.
 - In **APN Settings** area, select whether to automatically connect to APN, or set operator, name, user and password.
 In addition, you can press  after **APN Settings** to add an APN.
 - In **CORS settings** area, set NTRIP/CORS IP, port, base access point and server password.
 For base access point, it is generally set to the device serial number.
 In addition, you can press  after **CORS Settings** to customize information about the CORS server.
- If the data link is set to **External radio**, set baud rate.
 Default baud rate: 38400.
- If the data link is set to **Internal radio**, set the following:
 - **Channel and frequency**: channel 1~7 is fixed whose frequency is unchangeable; channel 8 is user-defined whose frequency can be set as needed.

 **CAUTION:** With this data link, the frequency and protocol settings of the rover and base should be the same.

 - **Protocol**: including Satel, PCC-GMSK, TrimTalk 450S, South 9600, HiTarget(9600), HiTarget(19200), TrimTalk(4800), GEOTALK, GEOMARK, HZSZ, etc.
 - **Power**: the power level of the base will affect the operating distance of the radio:
 - Low power and low power consumption lead to short operating distance.
 - High power and high power consumption lead to long operating distance.
- If the data link is set to **Dual**, see settings when the data link is set to **Device internet** and **External radio**.

4.3.3 Set Advanced Settings

To set advanced settings, do the following:

1. Press **Advanced**. **Advanced Settings** interface shows:

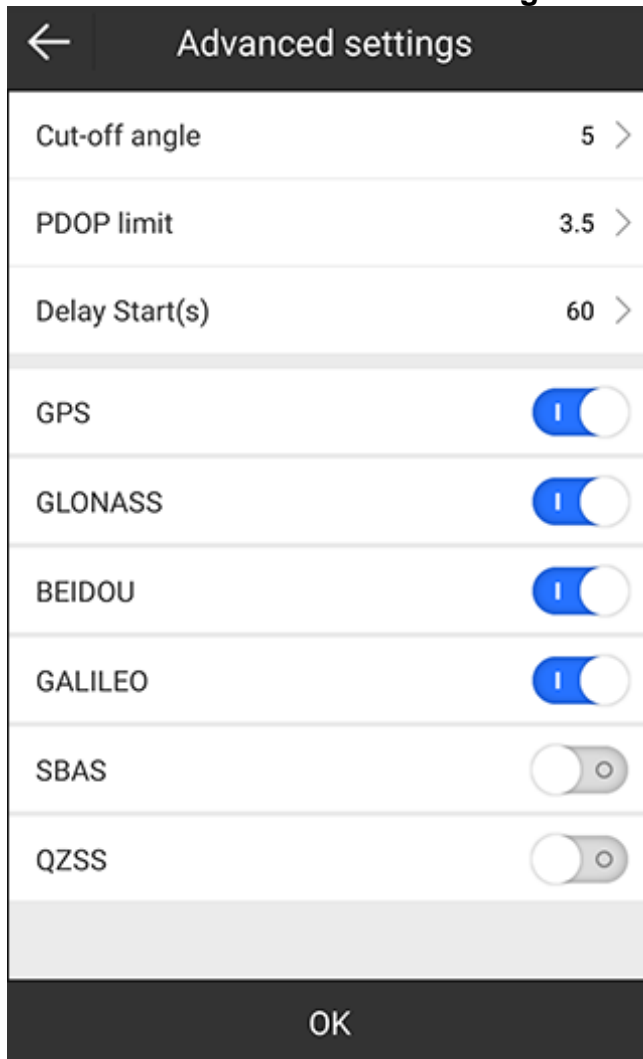

2. Set the following parameters:
 - **Cut-off angle:** the minimum vertical angle that is allowed to receive satellite signals. Signals below the angle will be ignored.
 - **PDOP limit:** the geometric strength factor of the satellite distribution. The smaller the PDOP value is, the better the satellite distribution is. When it is less than 3, it is the ideal state.
 - **Delay start (s):** it will give time to get better signal tracking and provide stable correction data especially when the base station is just powered on and the signal tracking is not good.
3. Set whether to receive signals from related systems:
See [4.2.2 Set Advanced Settings](#) for details.

4.4 Static

It is used to set the receiver as the static station.

Press main menu **Device** → **Static** to enter **Static mode settings** interface:

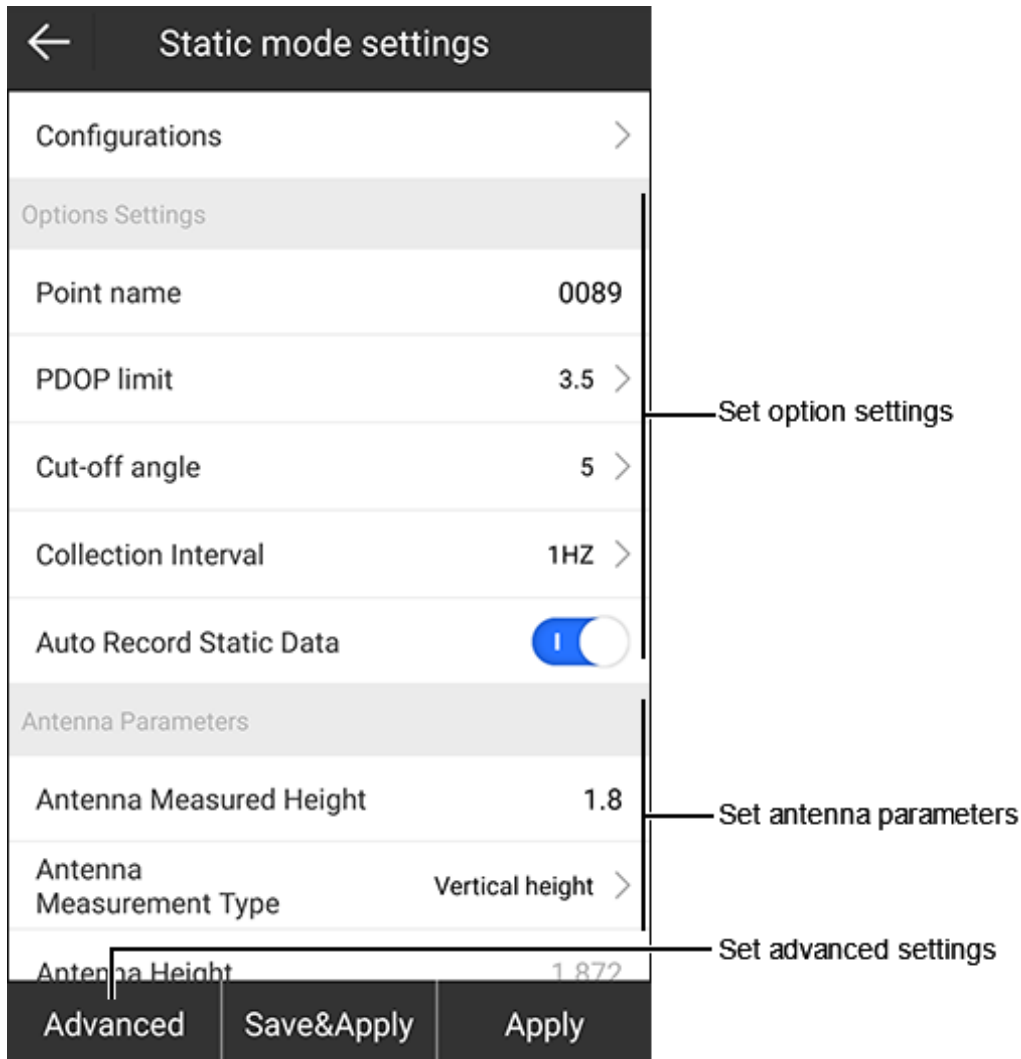

4.4.1 Set Option Settings

To set option settings, in **Options Settings** area, set the following:

- **Point name:** the point name of static data. It should be within 4 characters.
- **PDOP limit:** the geometric strength factor of the satellite distribution. The smaller the PDOP value is, the better the satellite distribution is. When it is less than 3, it is the ideal state.
- **Cut-off angle:** the minimum vertical angle that is allowed to receive satellite signals. Signals below the angle will be ignored.
- **Collection interval:** nHZ represents that the acquisition of data group(s) per second; ns represents that the acquisition of a group of data within second(s). The maximum interval depends on the receiver GNSS activation status.
- **Auto record static data:** to select whether the receiver automatically starts recording when it is powered on.

4.4.2 Set Antenna Parameters

Since the antenna height cannot be directly measured, it is automatically calculated by SurPad based on the measured height you input and measurement type you select.



CAUTION: No matter what the value of measured height you input and what kind of measurement type you select, the value of antenna height is unique.

To set antenna parameters, in **Antenna Parameters** area, set the following:

- **Antenna measured height:** its meaning depends on the antenna measurement type.
- **Antenna measurement type**
 - Height from phase center
 - Slant height form measuring line
 - Vertical height from measuring line
 - Slant height form altimetry
 - Vertical height
- **Antenna height:** the vertical height from the phase center of the antenna to the ground.

Principle

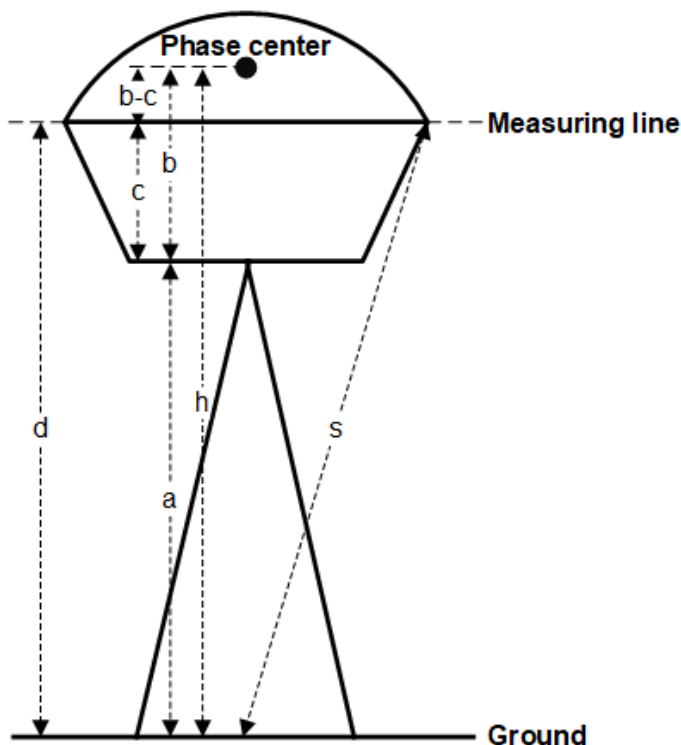

Among them:

- **a:** the vertical height form the bottom of the receiver to the ground.
- **b:** the vertical height from the bottom of the receiver to the phase center.
- **c:** the vertical height from the bottom of the receiver to the measuring line.
- **b-c:** the vertical height from the phrase center to the measuring line.
- **d:** the vertical height from the measuring line to the ground.
- **h:** the antenna height.

- **s**: the slant height form the measuring line to the ground.
- **R**: the radius of the rubber ring.
- **S**: the slant height from the altimetry piece to the ground with the known radius (R_c) of the alitimetry piece.

There are the following ways to calculate the antenna height:

Measured height	antenna measurement type	Antenna height
h	Height from phase center	$h = h$
s	Slant height form measuring line	$h = \text{sqrt}(s^2 - R^2) + (b - c)$
d	Vertical height from measuring line	$h = a + c + (b - c) = a + b$
S	Slant height from altimetry	$h = \text{sqrt}(S^2 - R_c^2) + b$
a	Vertical height	$h = a + b$

4.4.3 Set Advanced Settings

It is used to set whether to receive signals from the corresponding systems.

To set advanced settings, do the following:

1. Press **Advanced. Advanced Settings** interface shows:

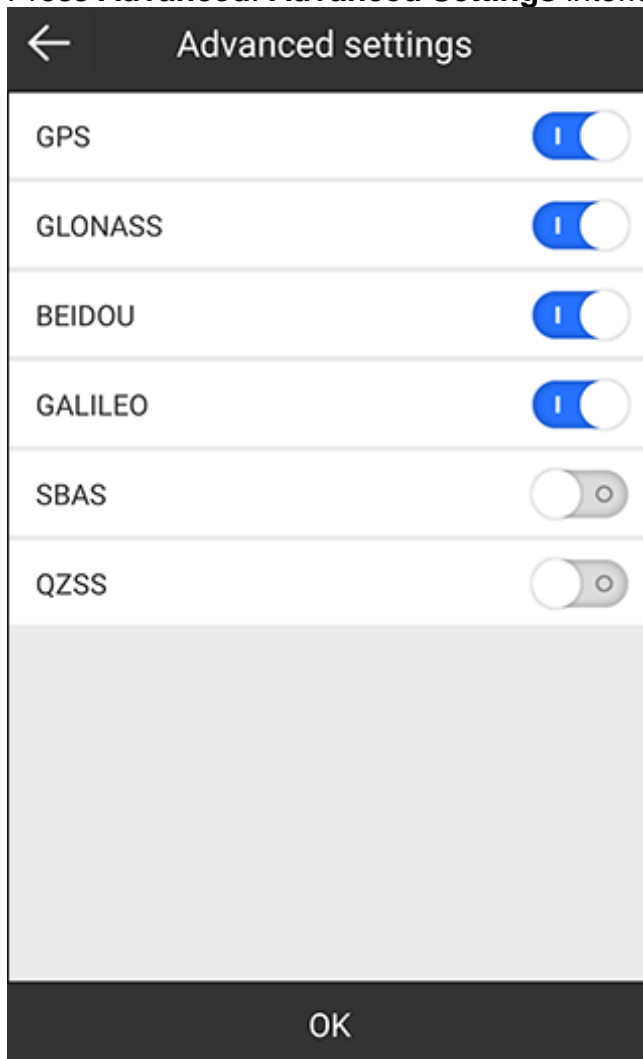

2. Set whether to receive signals from the following systems:
 - **GPS**
 - **GLONASS**
 - **BEIDOU**
 - **GALILEO**
 - **SBAS**: wide-area differential augmentation system (satellite-based augmentation system).
 - **QZSS**

4.5 Work Mode Status

It is used to check working information and work mode status.

Press **Device** → **Work Mode Status** to enter the following interface (taking rover station and data link is set to phone internet as an example):

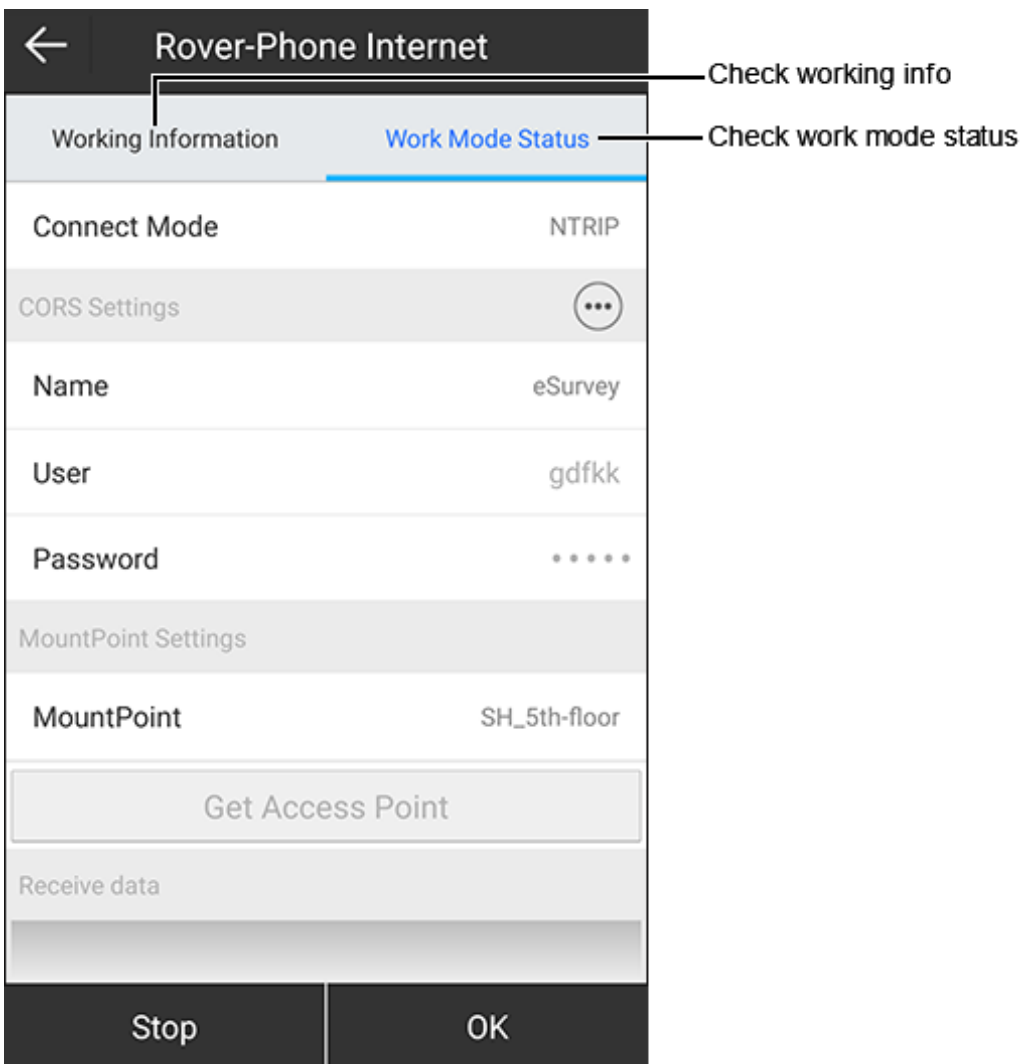

- Working information: including cut-off angle, whether record raw data is enabled, whether aRTK is enabled, and whether GPS, BEIDOU, GLONASS, GALILEO, SBAS, or QZSS is enabled.
- Working mode status: see [4.2 Rover](#) / [4.3 Base](#) / [4.4 Static](#) for details.

4.6 Configurations

It is used to check all configuration set which includes all work mode settings for the receiver.

In general, default settings can satisfy daily use.

Press main menu **Device** → **Configurations** to enter **Configurations** interface:

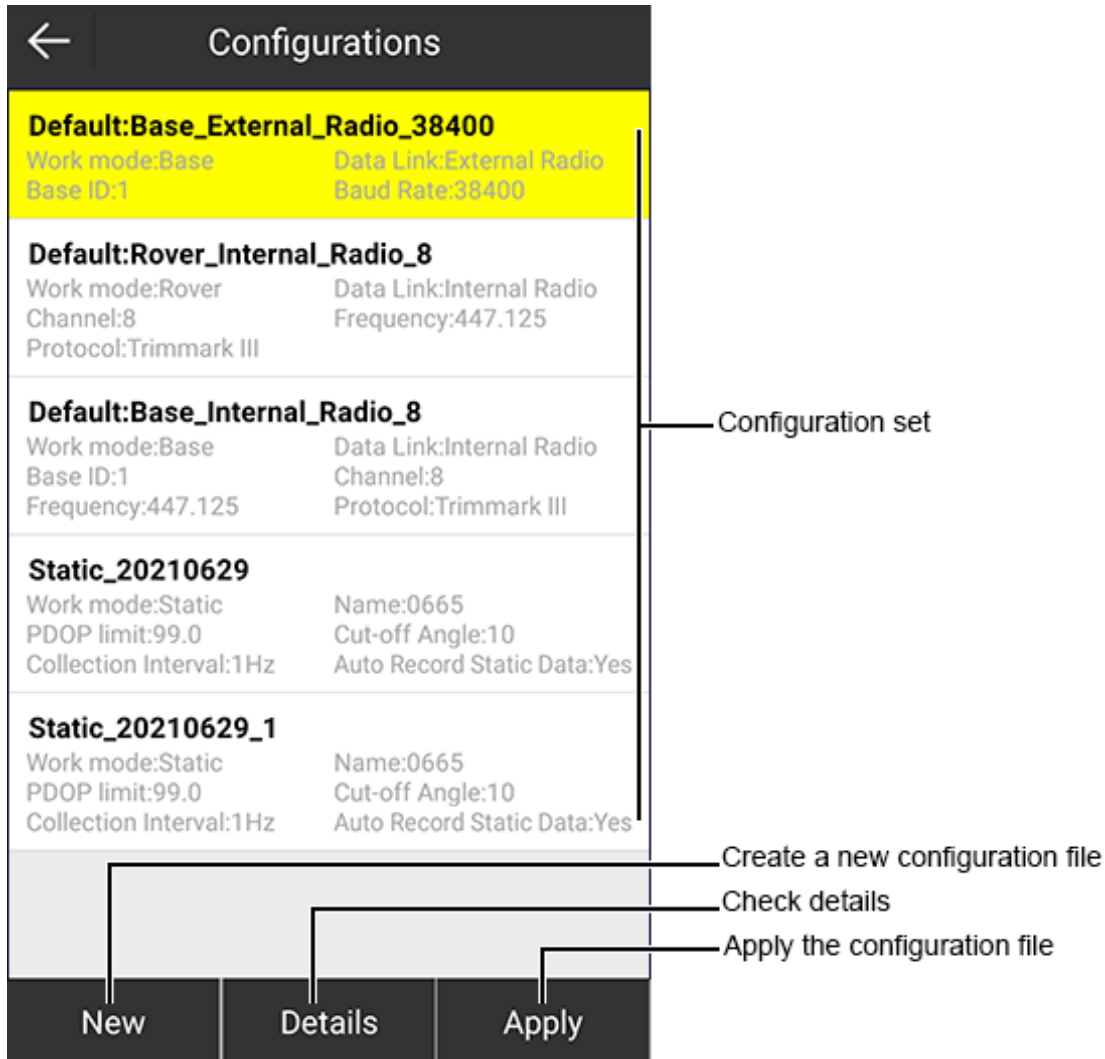

4.6.1 Create a New Configuration File

To create a new configuration file, do the following:

1. Press **New. Save to Configurations** interface shows:

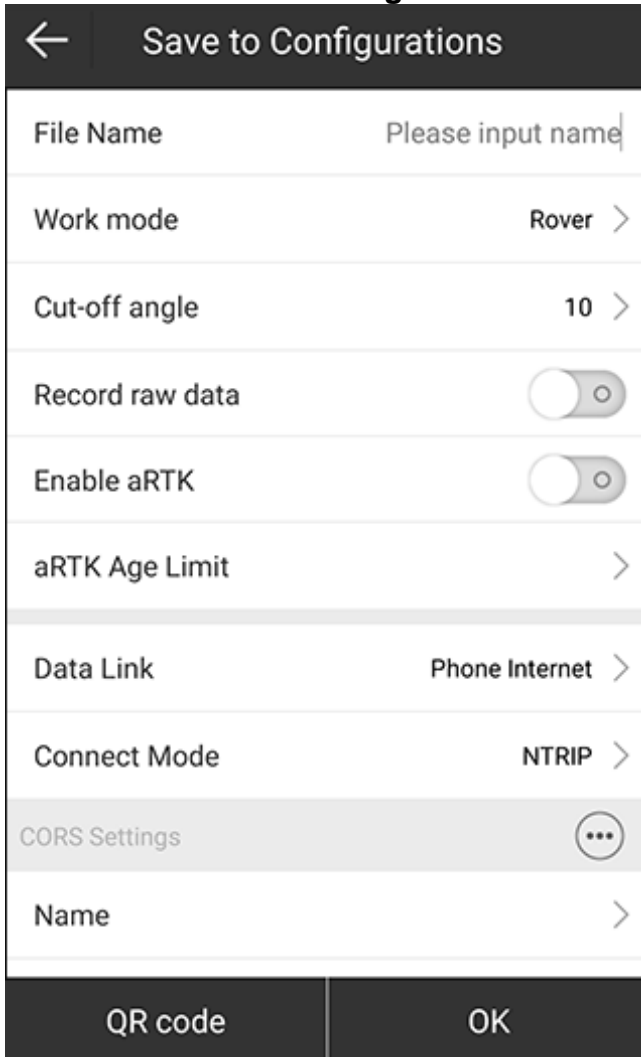

2. Set related information.
The setting differs in the setting of work mode and data link. See [4.2 Rover](#) / [4.3 Base](#) / [4.4 Static](#) for details.
3. **Optional:** To save the configuration file as a QR code and share it to others, do the following:
 - a. Press **QR code**. The QR code is automatically generated.
 - b. Press **Save**, and select the target path.
The QR code will save in JPG format.
4. Press **OK**.

4.6.2 Check Details

To check details of a configuration file, do the following:

1. Select the target configuration file.
2. Press **Details**. **Details** interface shows:

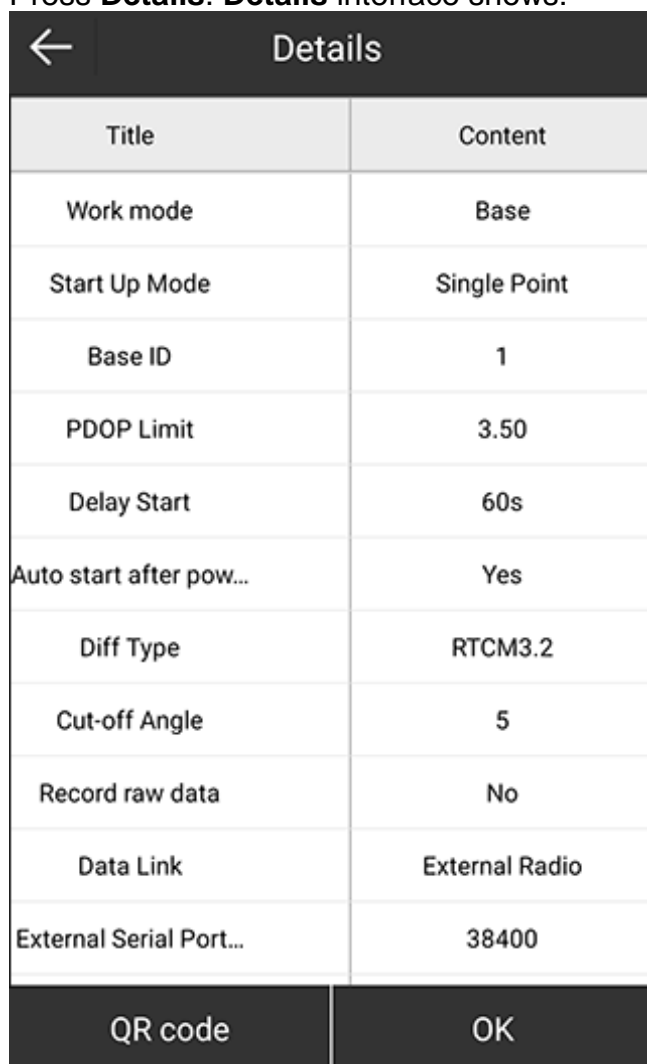

← Details	
Title	Content
Work mode	Base
Start Up Mode	Single Point
Base ID	1
PDOP Limit	3.50
Delay Start	60s
Auto start after pow...	Yes
Diff Type	RTCM3.2
Cut-off Angle	5
Record raw data	No
Data Link	External Radio
External Serial Port...	38400
QR code	OK

3. **Optional:** To save the configuration file as a QR code and share it to others, do the following:
 - a. Press **QR code**. The QR code is automatically generated.
 - b. Press **Save**, and select the target path.
The QR code will save in JPG format.
4. Press **OK**.

4.6.3 Apply the Configuration File

To apply the configuration file, do the following:

1. Select the target configuration file.
2. Press **Apply**.

4.7 Device Information

Press main menu **Device** → **Device Information** to enter **Device Information** interface:

Device Information	
Serial	E30P3A1900047
Model	E300 Pro
Hardware Version	V1.1
BIOS Version	1.05
Firmware Version	0.22.200922
GNSS Firmware Ver...	6.0Aa03x2
GNSS Serial	21800417
OS Version	1.08
MCU Version	2.61
Sensor Version	1.3.3
Work Mode	Rover
Current DataLink	Phone Internet

Device information	Network info	Radio info	Other
--------------------	--------------	------------	-------

Check device info
 Check network info
 Check radio info
 Check other info

4.8 Inspection Accuracy

It is used to calibrate the pole and check accuracy of the IMU. And it is required when tilt measurement is enabled and the IMU is used.

Press main menu **Device** → **Inspection Accuracy** to enter **Inspection Accuracy** interface:



For how to enable IMU tilt measurement, see [5.1.1 Enable IMU Tilt Measurement](#) for details.

4.8.1 Inspect Accuracy of Tilt Measurement

It is used to check if pole calibration is required.

To inspect accuracy of tilt measurement, do the following:

1. Set the following parameters:
 - **Antenna parameters**
 - **Average GPS count**
 - **Average GPS count**
 - **Average GPS interval**
 - **Exclusion abnormal point ratios (%)**
2. Press **Start**.

3. Move the pole $0^{\circ} \sim 90^{\circ}$, and wait the value of **Record number($0^{\circ} \sim 90^{\circ}$)** turns to **5/5**.
4. Move the pole $90^{\circ} \sim 180^{\circ}$, and wait the value of **Record number($90^{\circ} \sim 180^{\circ}$)** turns to **5/5**.
5. Move the pole $180^{\circ} \sim 270^{\circ}$, and wait the value of **Record number($180^{\circ} \sim 270^{\circ}$)** turns to **5/5**.
6. Move the pole $270^{\circ} \sim 360^{\circ}$, and wait the value of **Record number($270^{\circ} \sim 360^{\circ}$)** turns to **5/5**.

The result shows as follows:

← Inspection accuracy				← Inspection accuracy			
Exclusion abnormal point ratio(%)		0 >		Exclusion abnormal point ratio(%)		0 >	
FIXED				FIXED			
Record number($0^{\circ} \sim 90^{\circ}$)		5/5		Record number($0^{\circ} \sim 90^{\circ}$)		5/5	
Record number($90^{\circ} \sim 180^{\circ}$)		5/5		Record number($90^{\circ} \sim 180^{\circ}$)		5/5	
Record number($180^{\circ} \sim 270^{\circ}$)		5/5		Record number($180^{\circ} \sim 270^{\circ}$)		5/5	
Record number($270^{\circ} \sim 360^{\circ}$)		5/5		Record number($270^{\circ} \sim 360^{\circ}$)		5/5	
Test results				Test results			
Δ plane max(mm)		29.827		Δ plane max(mm)		60.33	
Δ height max(mm)		6.63		Δ height max(mm)		43.961	
Maximum tilt angle		20°16'15.2767"		Maximum tilt angle		29°21'59.7194"	
Min(N)	3439879.1...	Max(N)	3439879.1...	Min(N)	3439871.2...	Max(N)	3439871.3...
Min(E)	359818.998	Max(E)	359819.047	Min(E)	359721.779	Max(E)	359721.884
Min(H)	59.997	Max(H)	60.008	Min(H)	515.538	Max(H)	515.615
Restart		Pole calibration		Restart		Pole calibration	

- If the result shows in red, the accuracy is not enough, calibrating the pole is required.
- If not, calibrating the pole is not required.

4.8.2 Calibrate the Pole

It is required when tilt measurement is not accurate due to the wear of pole tip or change of the pole.

To calibrate the pole, do the following:

1. To enter **Pole Calibration** interface, press **Pole Calibration**:

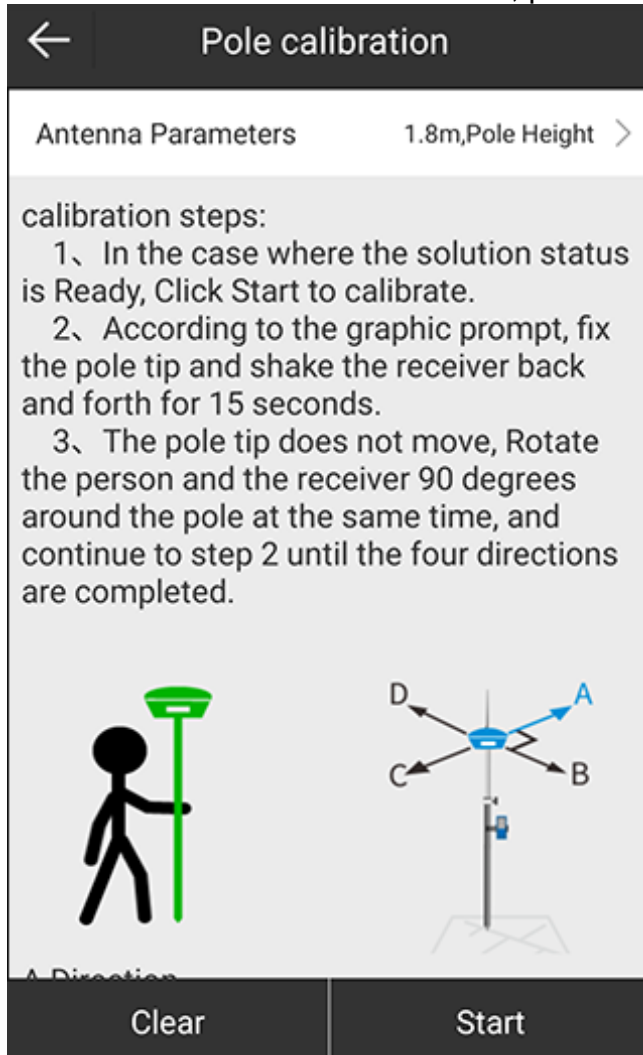

2. Fix the pole tip and shake the receiver back and forth for 15 s.
3. Rotate 90° without moving the pole, and shake the receiver back and forth for 15 s.
4. Repeat step 3 until you rotate 360°.

After calibrating the pole, a prompt *Calibrated successfully* shows at the bottom of the interface.

If calibrating the pole fails, find a new area to do calibrating again.

4.9 Calibrate Sensor

It is required when tilt measurement is used and E-bubble is used.

Before calibrating the sensor, to enable E-bubble tilt measurement, press main menu **Device** → **Device Setting**, set tilt survey to **E-Bubble**, and press **OK**.

To calibrate the sensor, do the following:

1. To enter **E-Bubble** interface, press main menu **Device** → **Calibrate Sensor**:

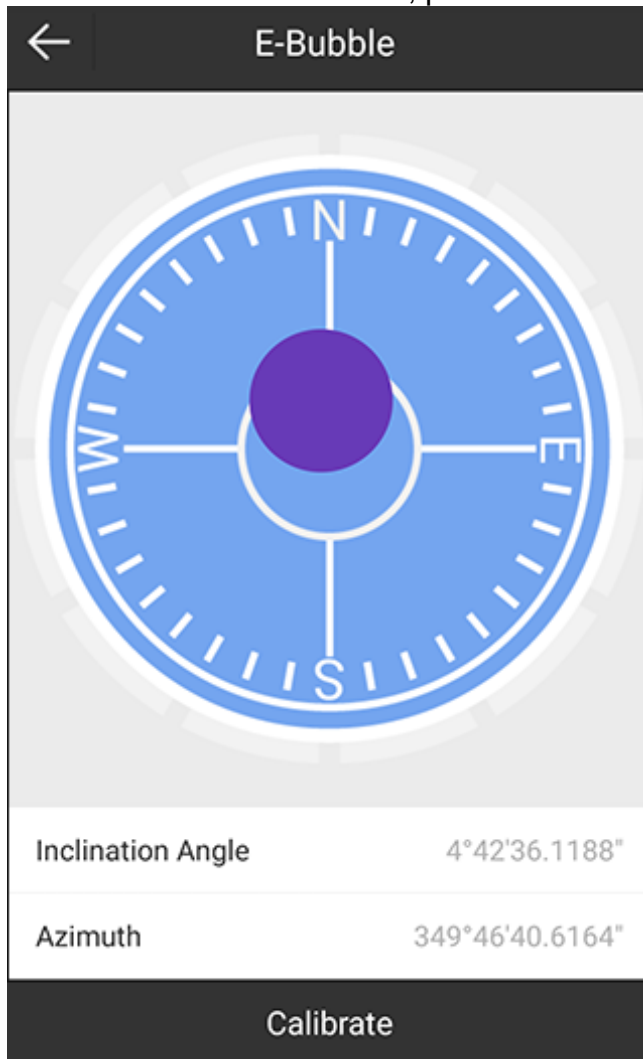

2. Put the receiver on a flat place.
3. Press **Calibrate**. The E-bubble turns to green.

4.10 Device Settings

Press main menu **Device** → **Device Settings** to enter **Device Settings** interface:

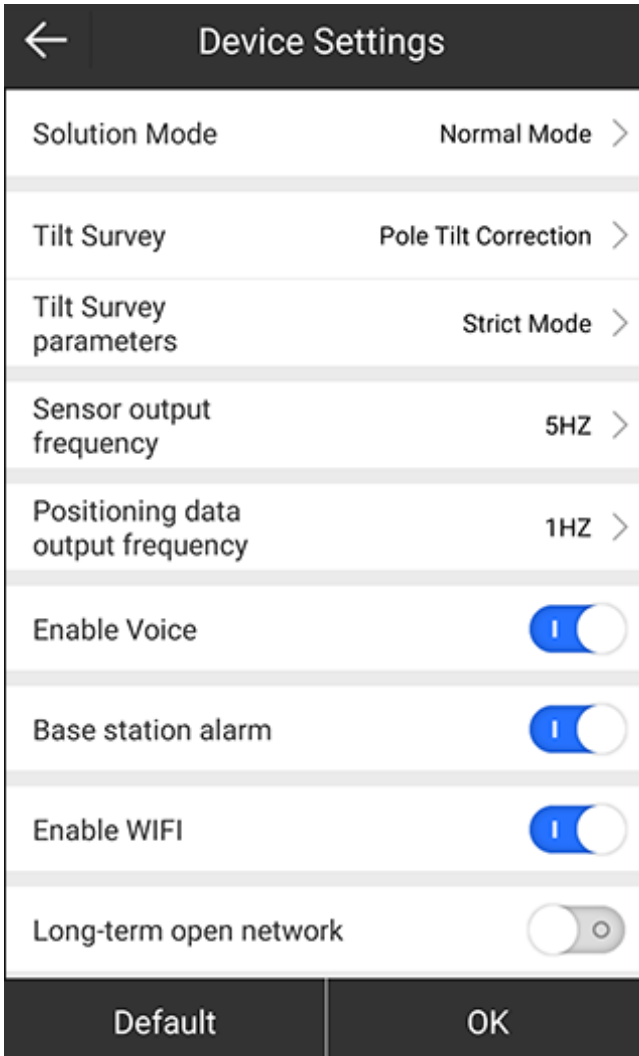

- **Solution mode:** including normal mode, survey mode and strict mode (in this mode, reliability of solution can be improved.)
- **Tilt survey:** to enable pole tilt correction (IMU or E-bubble).
- **Tilt survey parameters:** including normal mode, strict mode or user-defined mode.
- **Positioning data output frequency:** to set the output frequency of the positioning data.
- **Enable voice:** to select whether to enable receiver voice broadcast function.
- **Base station alarm:** to select whether to remind you when the base station is moved. With it enabled, the rover receiver will broadcast *Base is moved*.
- **Enable WIFI:** to select whether to enable receiver WIFI.
- **Long-term open network:** to select whether to enable long-term open network. With it enabled, the network initialization will be faster. It is suggested to enable it when a SIM card is used.
- **WIFI share network:** to select whether to share network through WiFi when a SIM card is inserted on the receiver.
- **Base coordinate change alert:** to select whether to remind you when coordinates of the base station changes.

4.11 Default Radio Settings

To set default radio settings, do the following:

1. Press main menu **Device** → **Default Radio Settings** to enter **Default Radio Settings** interface:

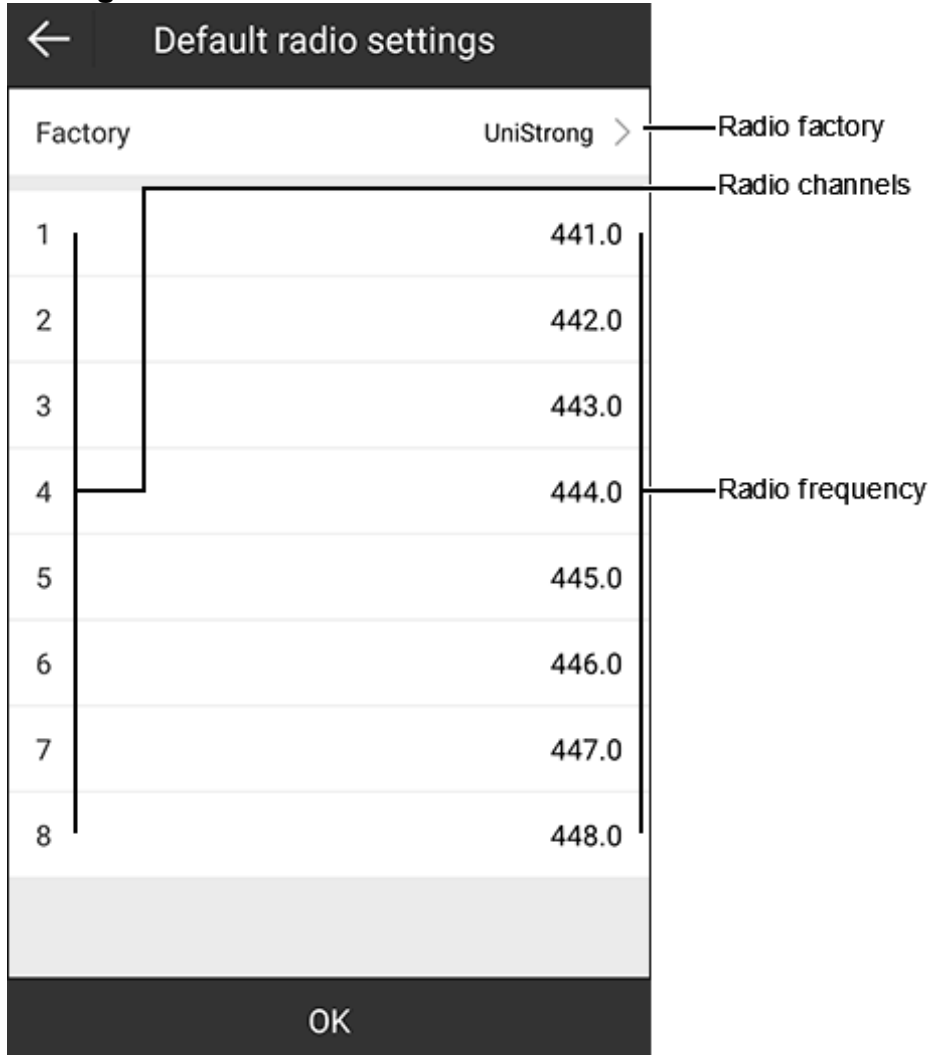

2. To set radio frequency, do one of the following:
 - To use radio frequency of the target factory, press **Factory**, and select the target factory.
 - To customize radio frequency, press value of the radio frequency, and input a value.
3. Press **OK** for confirmation.

4.12 Restart Positioning

It is used to control the receiver to clear the current ephemeris information, so as to initialize OEM board and receive satellites signals again for positioning.

To restart positioning, do the following:

1. Press main menu **Device** → **Restart Positioning**. A prompt *Restart positioning?* shows.
2. Press **OK** for confirmation.

4.13 Device Activation

Press main menu **Device** → **Device Activation** to enter **Device Activation** interface:

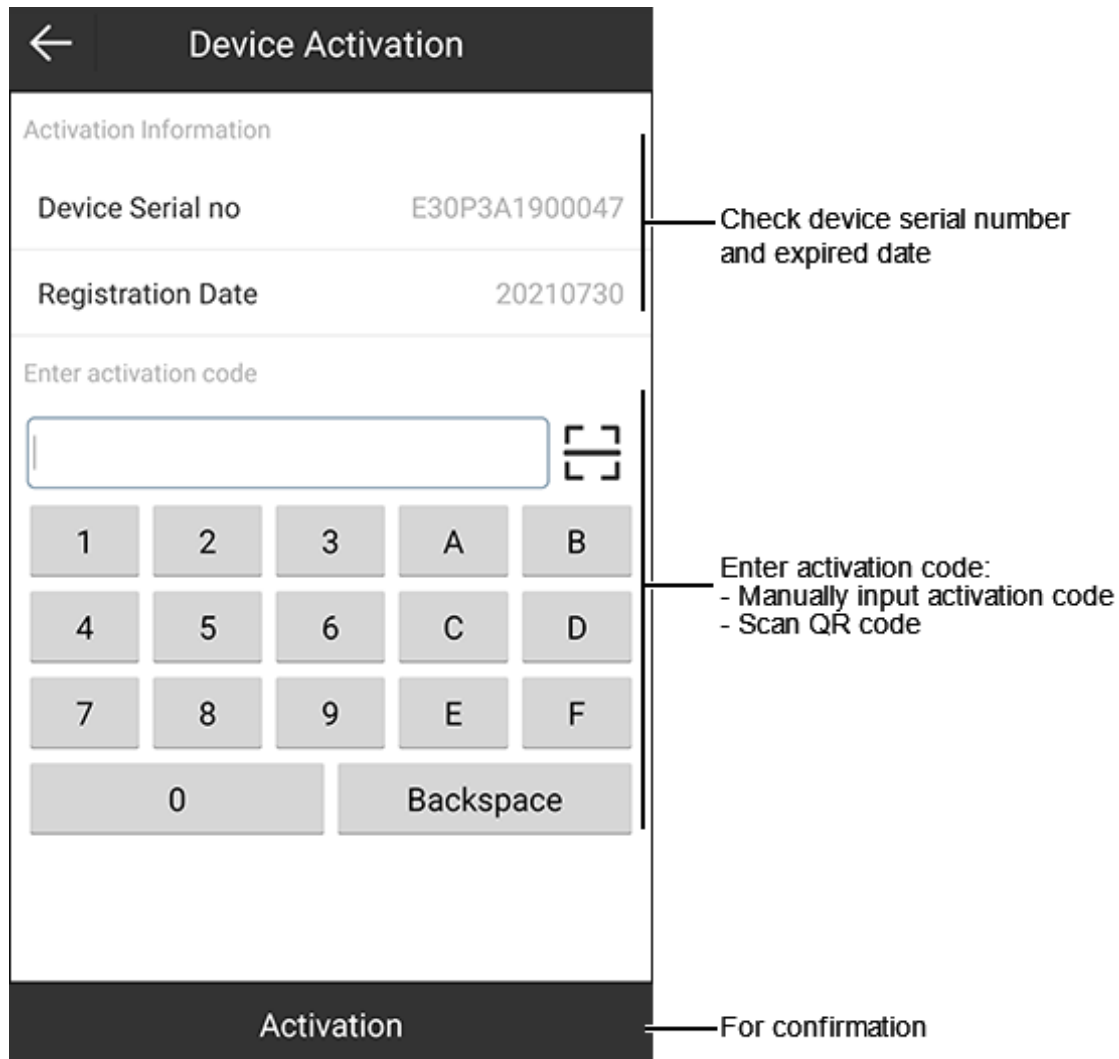

The screenshot shows the 'Device Activation' interface. At the top, there is a back arrow and the title 'Device Activation'. Below this, the 'Activation Information' section displays 'Device Serial no' as E30P3A1900047 and 'Registration Date' as 20210730. A line points to these fields with the annotation 'Check device serial number and expired date'. The next section is 'Enter activation code', which includes a text input field and a QR code scanner icon. Below the input field is a numeric keypad with buttons for digits 1-9, 0, and Backspace, along with letters A-F. A line points to this keypad with the annotation 'Enter activation code: - Manually input activation code - Scan QR code'. At the bottom of the screen is a dark bar with the word 'Activation' in white text, with a line pointing to it and the annotation 'For confirmation'.



5 Survey

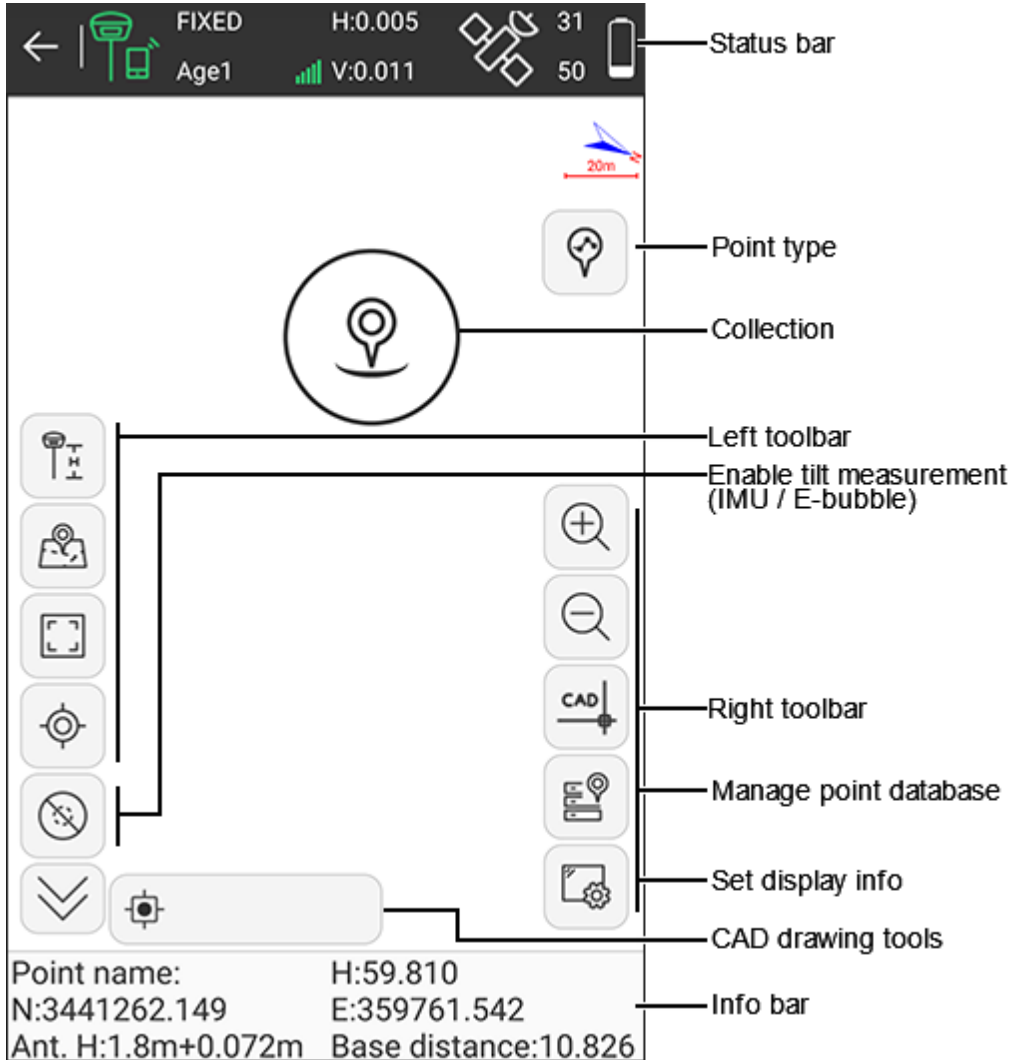

5.1 Point Survey

Press main menu **Survey** → **Point Survey**.





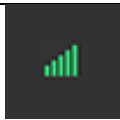

Status bar

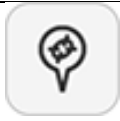

Status icon	What it does
	To exit point survey interface.
	To show the operation mode of the receiver. You can press it to enter Rover / Base / Static mode settings interface. See 4.2 Rover / 4.3 Base / 4.4 Static for details.
	To show the solution status (including single, float, differential and fixed) and the differential delay in real-time.

Status icon	What it does
	To show the differential signal of the receiver.
H:0.005 V:0.01	H: to show the horizontal accuracy. V: to show the vertical accuracy.
	To check the current positioning information.
35 43	35: to show the number of used satellites. 45: to show the number of observed satellites.
	To show the battery level of the receiver.

Point type





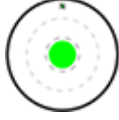





Icons	What it does
	Topo point
	Control point
	Quick point
	Automatic point
	Corner point (only when E-bubble is used)
	Tilt point (only when E-bubble is used)















Collection









Icons	What it does
	To collect coordinates of the current point with tilt survey disabled.
	To start IMU tilt measurement with tilt survey enabled and IMU used. See 5.1.1 Enable IMU Tilt Measurement for details.
	To start E-bubble tilt measurement with tilt survey enabled and E-bubble used.

You can freely drag the collection icon to any position.





Left toolbar

Icons	What it means
	Redraw (to refresh the current displayed data.)
	Antenna parameters
	Switch map
	Full map
	Jump map center
	Tilt survey is disabled.
	IMU tilt survey is enabled. See 5.1.1 Enable IMU Tilt Measurement for details.
	E-bubble tilt survey is enabled.
	To collapse icons in the left toolbar.
	To expand icons in the left toolbar.













Icons	What it means
	Display content
	CAD background color
	Compass
	Offset point calculation
	Equal point calculation
	Coordinate positive calculation
	Forward intersection
	Resection
	Intersection calculation
	Two lines angle
	Great-circle distance
	Point line calculation
	Coordinate inverse calculation
	Calculator
	Restart positioning

Icons	What it means
	Static and collect points
	Perimeter and area
	Coordinates converter
	Screen measurement
	CAD text
	Automatic scaling
	Auto jump map center
	Take screen point

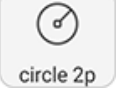
Right toolbar

Icons	What it does
	To zoom out the graphic.
	To zoom in the graphic.
	To enter Points Database interface. See 3.5 Point Database for details.
	To set display information. See 5.1.3 Set Display Information for details.

CAD drawing tools

Icons	What it does
 <p>square</p>	To draw a square.
 <p>line</p>	To draw a line.
 <p>polyline</p>	To draw a polyline.
 <p>rect</p>	To draw a rectangle.
 <p>rect center</p>	To draw the center of a rectangle.
 <p>polygon</p>	To draw a polygon.
 <p>circle 2p</p>	To draw a circle by two points.
 <p>circle 3p</p>	To draw a circle by three points.
 <p>arc</p>	To draw an arc.
 <p>point</p>	To draw a point.
 <p>Spline</p>	To draw a spline.
 <p>Default</p>	To enter Layer Settings interface.





Information bar

- **Point name:** the point name of collected point.
- **N, E, H:** the horizontal coordinates (projection point) of the current point.
- **Ant. H:** the antenna height in survey.
- **Base distance:** the distance from the current rover station to the base station.

5.1.1 Enable IMU Tilt Measurement



To enable IMU tilt measurement, in left toolbar, press , and do as the prompt in the interface:

Status	What it means	What to do
	Magnetic calibration is required.	Take the pole and draw a circle towards the ground.
	Initialization is required.	Shake the pole or walk around.
	The accuracy of tilt measurement is not enough.	Wait.
	The tilt angle exceeds 60°.	Make sure the tilt angle is within 0° ~ 60°.
	Tilt measurement is successfully enabled.	Start survey.

5.1.2 Manage Point Database

The operation is the same with operation in main menu **Project**. See [3.5](#) Point Database for details.

5.1.3 Set Display Information

It is used to customize display information, including topo point, information bar, and toolbars.

To set display information, do the following:



1. In the main interface of line stakeout, press **Display Information** interface shows:

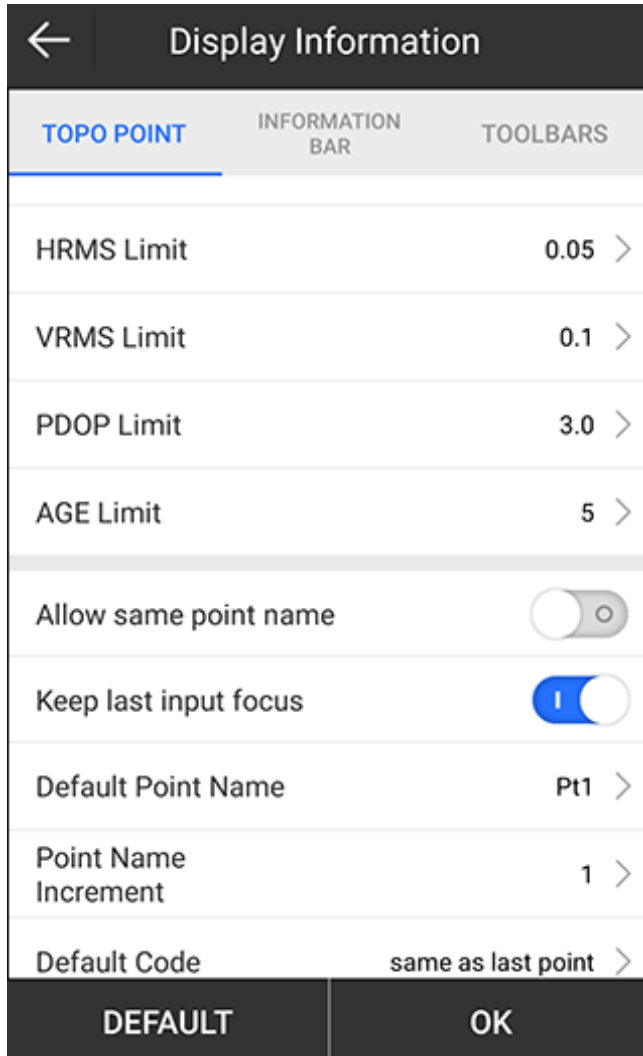

Display Information	
TOPO POINT	INFORMATION BAR
HRMS Limit	0.05 >
VRMS Limit	0.1 >
PDOP Limit	3.0 >
AGE Limit	5 >
Allow same point name	<input type="checkbox"/>
Keep last input focus	<input checked="" type="checkbox"/>
Default Point Name	Pt1 >
Point Name Increment	1 >
Default Code	same as last point >

2. To set point limit, do the following:
 - a. Set recording limit, including solution limit, HRMS limit, VRMS limit, PDOP limit, and AGE limit.
 - b. Select whether to allow the same point name and keep the last input focus.
 - c. Set or select the default point name, and set the increment of the point name, and default code.
 - d. Set or select the average GPS count.

3. To customize the information bar / toolbars, do the following:
- To switch to **INFORMATION BAR / TOOLBARS** page, press **INFORMATION BAR / TOOLBARS**:

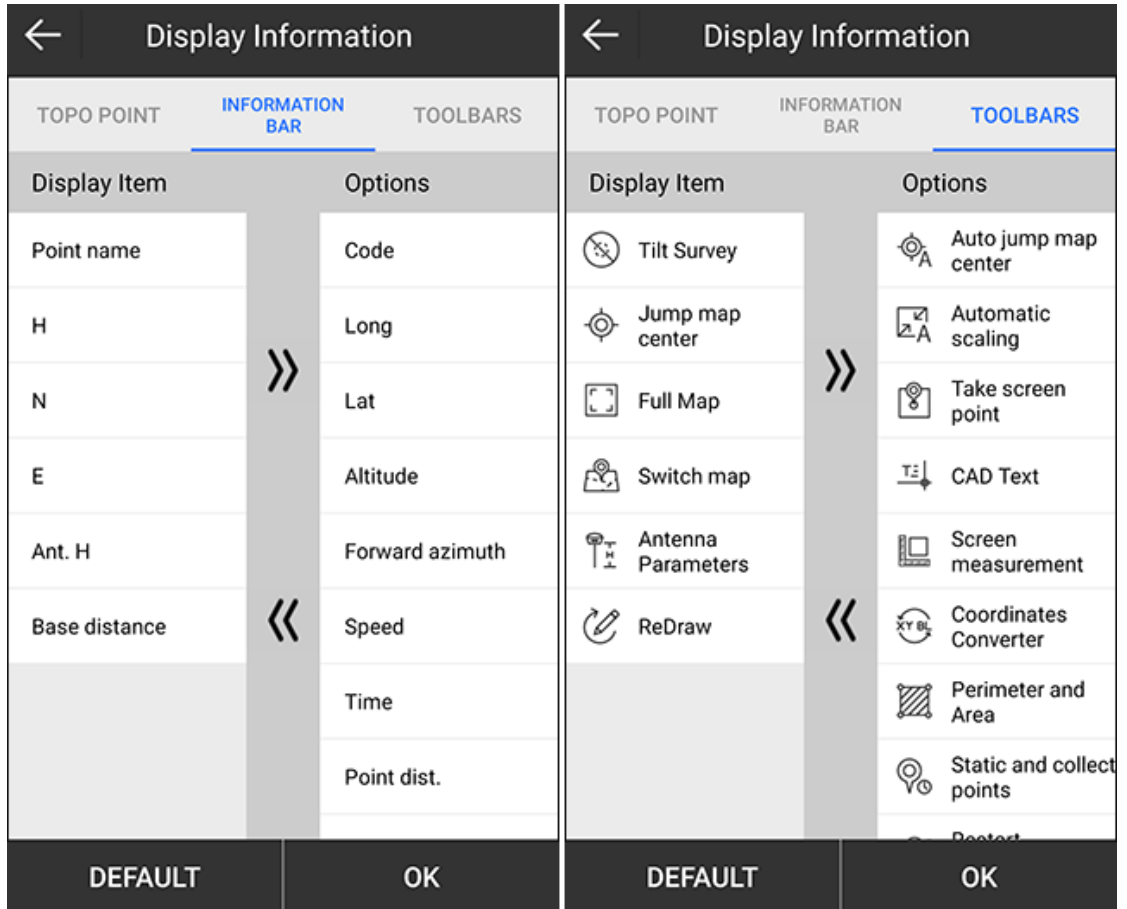

- To remove information from **Display Item** list, select the target information in



Display Item list, and press

- To add information to **Display Item** list, select the target information in





Options list, and press

- Optional:** To restore settings to default settings, press **Default**.
- To save settings, press **OK**.



5.1.4 Start Point Survey

5.1.4.1 Start Survey for a Topo Point

To start survey for a topo point, do the following:

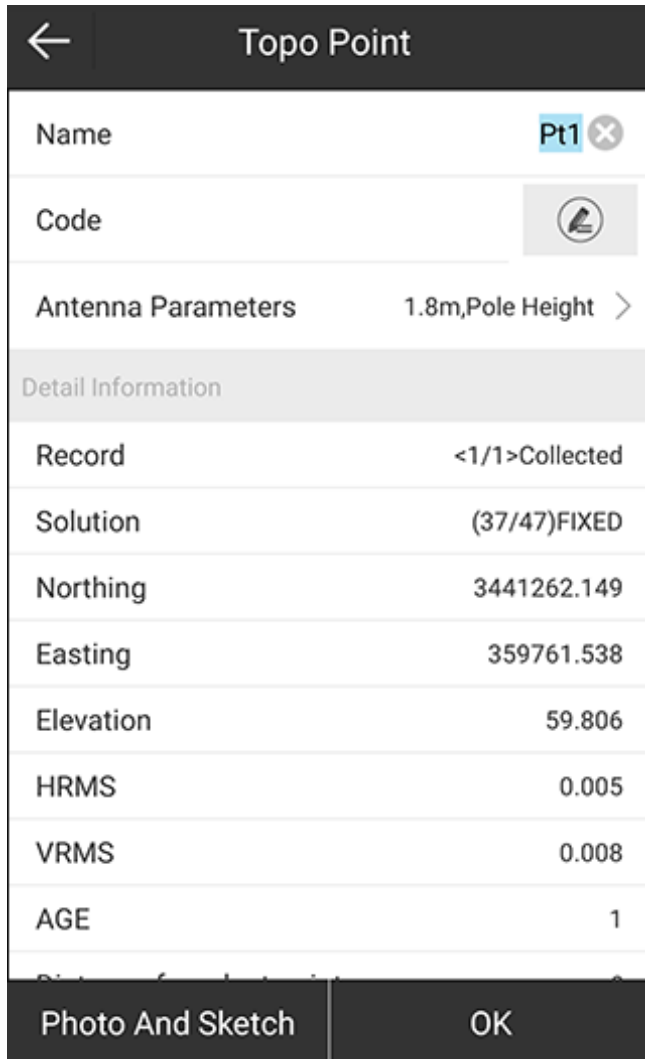
1. Select  in the point type area, and press . **Topo Point** interface shows:









Topo Point	
Name	Pt1 
Code	
Antenna Parameters	1.8m,Pole Height >
Detail Information	
Record	<1/1>Collected
Solution	(37/47)FIXED
Northing	3441262.149
Easting	359761.538
Elevation	59.806
HRMS	0.005
VRMS	0.008
AGE	1
Photo And Sketch	
OK	



 **CAUTION:** Only when the current point meets the set display limit, **Topo Point** interface shows. Otherwise, a prompt shows.

2. Set point name, code, and antenna parameters, and check detail information.

3. **Optional:** Press **Photo and Sketch** and make an information note on the collected points, including documents, pictures, graphs in **Photo and Sketch** interface:





Icons	What it does	
	Undo	To undo and return to the previous step.
	Note	To add a note with the customized font size and color.
	Point info	To add point information, including name, code, northing, easting, height, etc. with the customized font size and color.
	Arrow	To add arrows with the customized color and style.
	Drawing	It is similar to the pencil function in Windows Paint. You can customize the color and thickness.
	Photo	To directly invoke camera to take a picture to add into information.
	Move	To move any added information.

Icons		What it does
	Rotate	To rotate any added information.
	Zoom	To zoom in or out any added information.
	Clear	To clear all information.

4. To save the topo point, press **OK**.

5.1.4.2 Start Survey for Control Points

To start survey for control points, do the following:

1. Select  in the point type area, and press  to enter the following interface:

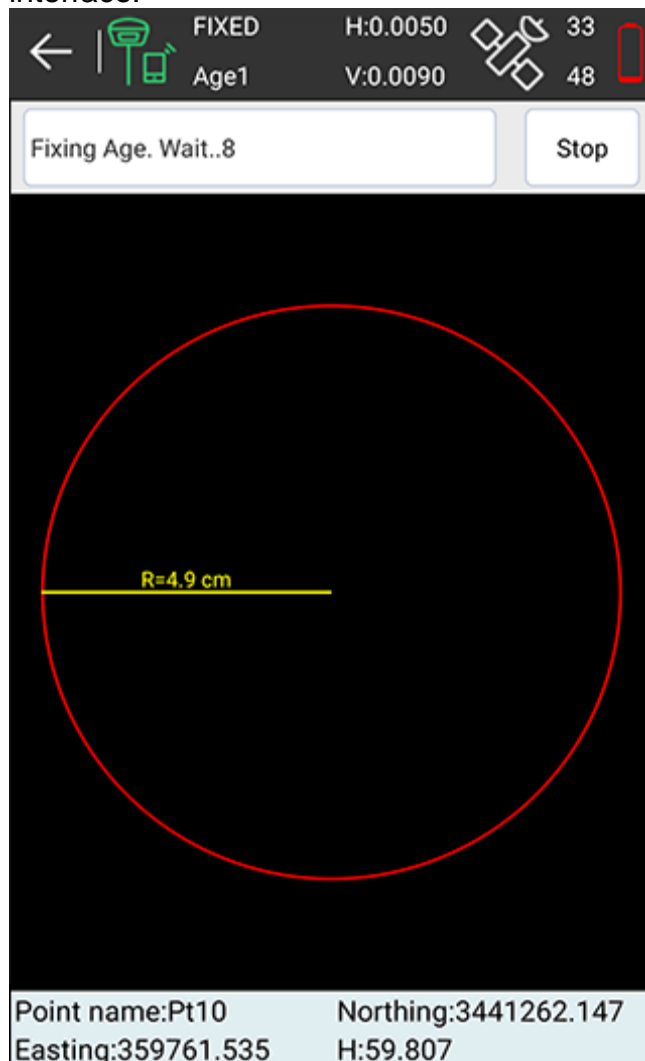

SurPad automatically starts to collect points every set interval and enters **Control Point** interface until it finishes the set total number:

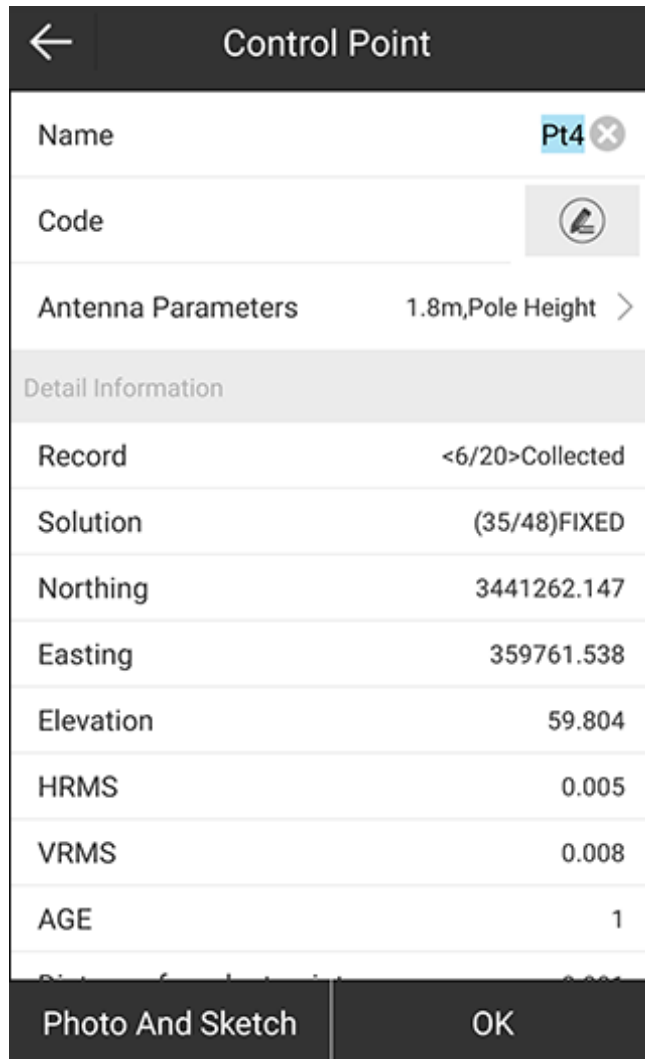

The screenshot shows the 'Control Point' interface with the following fields and data:

- Name:** Pt4
- Code:** (empty)
- Antenna Parameters:** 1.8m, Pole Height
- Detail Information:**

Record	<6/20>Collected
Solution	(35/48)FIXED
Northing	3441262.147
Easting	359761.538
Elevation	59.804
HRMS	0.005
VRMS	0.008
AGE	1

At the bottom, there are two buttons: 'Photo And Sketch' and 'OK'.





- Set point name, code and antenna height. A prompt *Control point report generated, named as xxx, would like to view it now?* shows.

3. **Optional:** To save the control point, press **OK**. The control point report is generated:

GPS control point measurement report		
Basic Information		
Project ame	(202c10630 - 202c10630.PD)	
Operator		
Report Time	2021-07-05 15:44:10	
Antenna Height	1.8715000000000002	
Observation Time	63	
Coordinate systems parameters		
Coordinate system name	Default	
Ellipsoid Parameter	Ellipsoid Name	WGS-84
	Semimajor axis	6378137.0
	1/f	298.257223563
Projections Mode	Projections Mode	Gauss Kruger
	Central Meridian	E123°00'00"



5.1.4.3 Start Survey for a Quick Point

To start survey a quick point, do the following:

1. Select  in the point type area.
2. Set a point name behind icon .
3. Do one of the following:
 - To set a code, directly input a code behind icon .
 - To select a code that already exists, press , and select a code.
4. Press . SurPad automatically starts collection after prompt voice and saves the quick point.

5.1.4.4 *Collect Automatic Points*

To collect automatic points, do the following:

1. Select  in the point type area, and press . **Auto Point** interface shows:

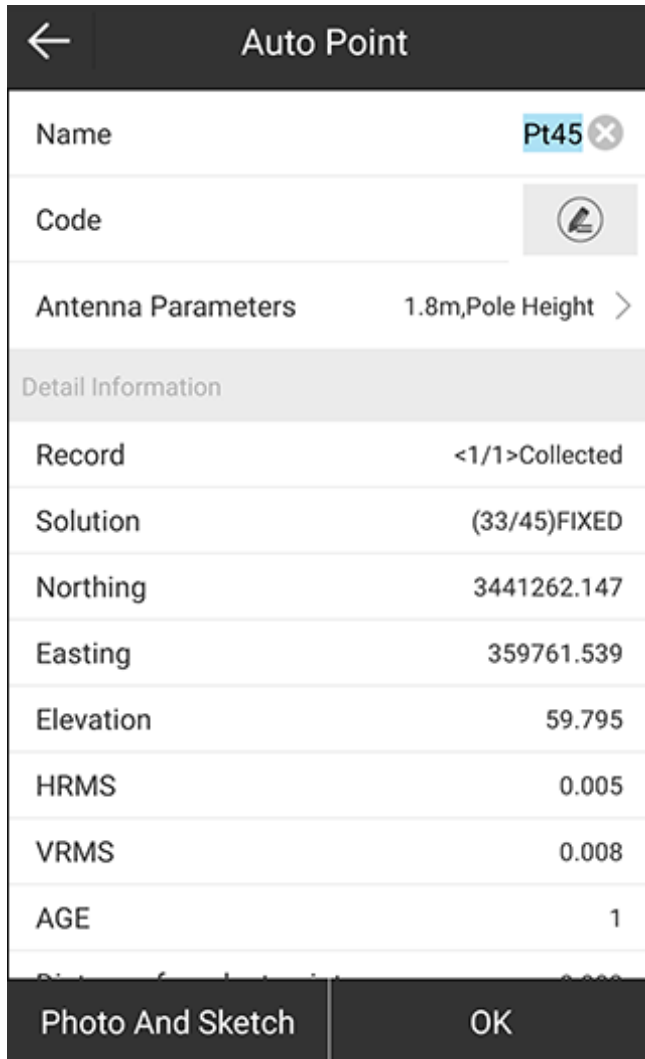

The screenshot shows the 'Auto Point' interface with the following fields and data:

Auto Point	
Name	Pt45 ✕
Code	
Antenna Parameters	1.8m,Pole Height >
Detail Information	
Record	<1/1>Collected
Solution	(33/45)FIXED
Northing	3441262.147
Easting	359761.539
Elevation	59.795
HRMS	0.005
VRMS	0.008
AGE	1
Photo And Sketch	
OK	

- Set point name, code and antenna height, and click **OK**. SurPad automatically starts to collect point until you interrupt the progress by pressing one of the following:

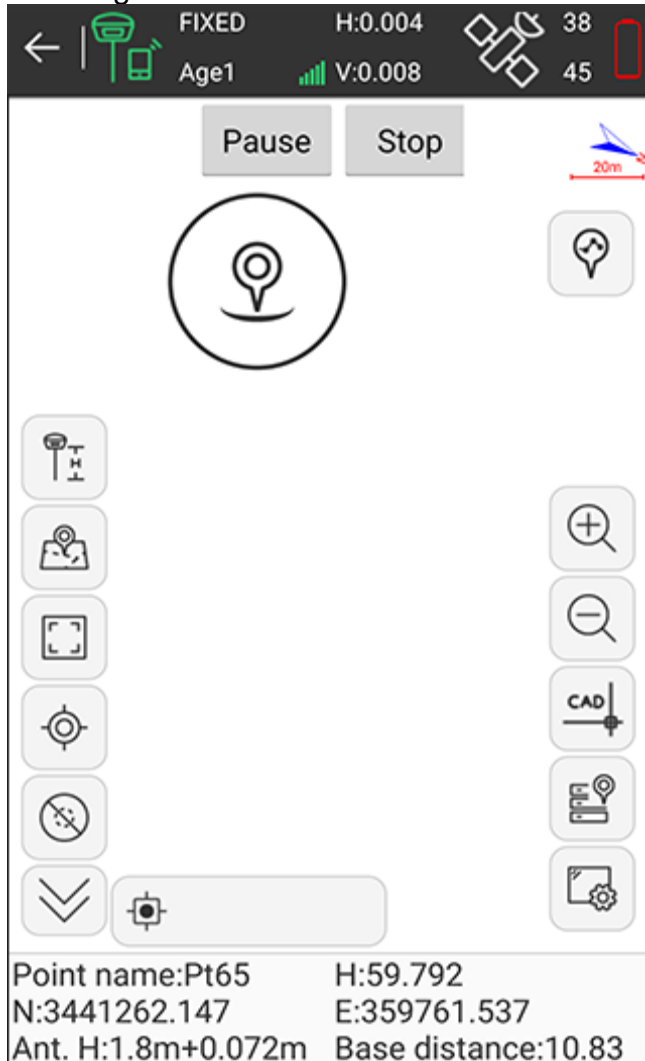



- **Pause**: to pause the collecting progress. To resume the collecting, you can press **Start**.
- **Stop**: to stop the collecting progress.

5.1.4.5 Start Survey for a Corner Point

SurPad will automatically calculate coordinates of the pole tip according to the automatically collected 20 points.

It is available only when E-bubble is used.

To start survey for a corner point, do the following:

1. Select  in the point type area, and press . The following interface shows:

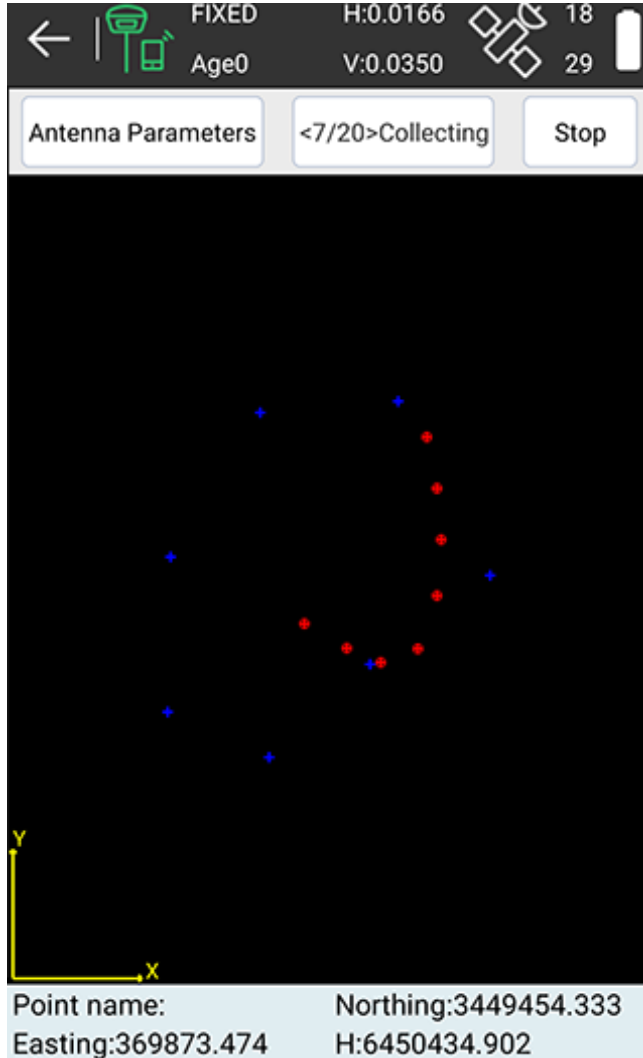

2. **Optional:** To modify antenna parameters, press **Antenna Parameters**, and set antenna parameters.

- 3. Draw circles with the pole without moving the pole tip. SurPad automatically collects 20 points:

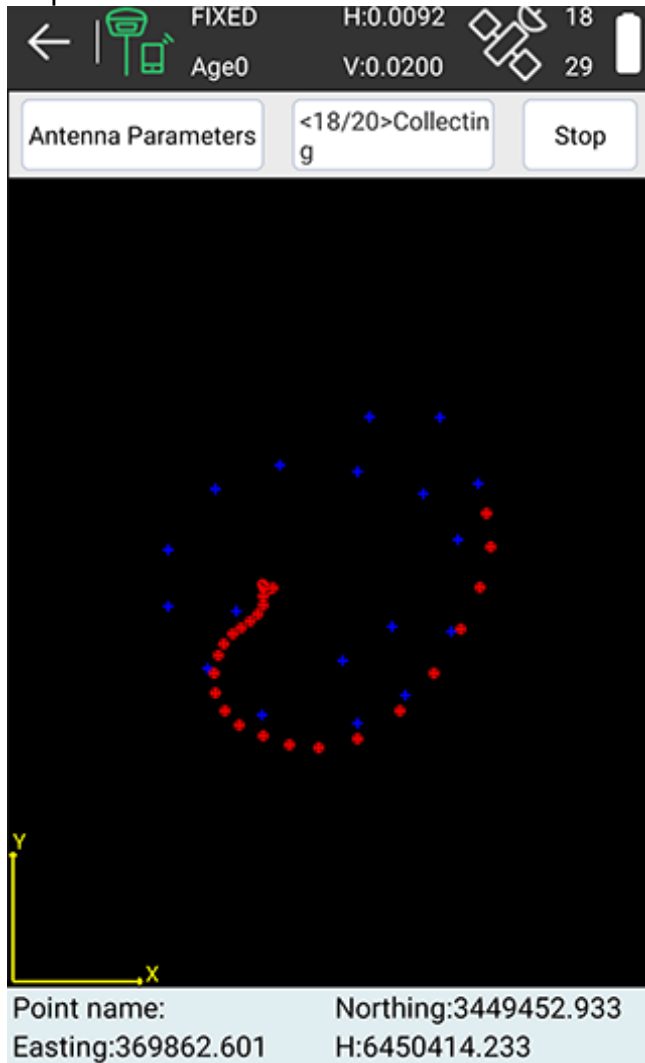

4. After 20 points are collected, press **OK** in **Corner Point** interface:

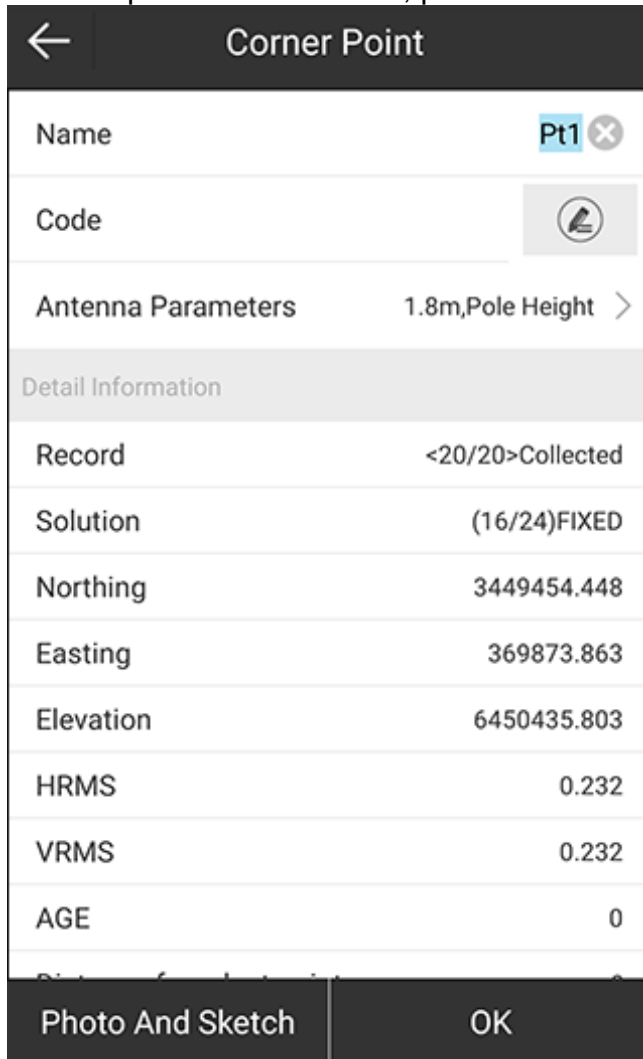

Corner Point	
Name	Pt1 <input type="text"/>
Code	<input type="text"/>
Antenna Parameters	1.8m,Pole Height >
Detail Information	
Record	<20/20>Collected
Solution	(16/24)FIXED
Northing	3449454.448
Easting	369873.863
Elevation	6450435.803
HRMS	0.232
VRMS	0.232
AGE	0

Photo And Sketch OK

5.1.4.6 *Start Survey for a Tilt Point*

It is available only when E-bubble is used.

Before starting survey for a tilt point, press  to enable tilt measurement.

To start survey for a tilt point, do the following:

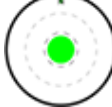
1. Select  in the point type area, and press . **Tilt Point** interface shows:

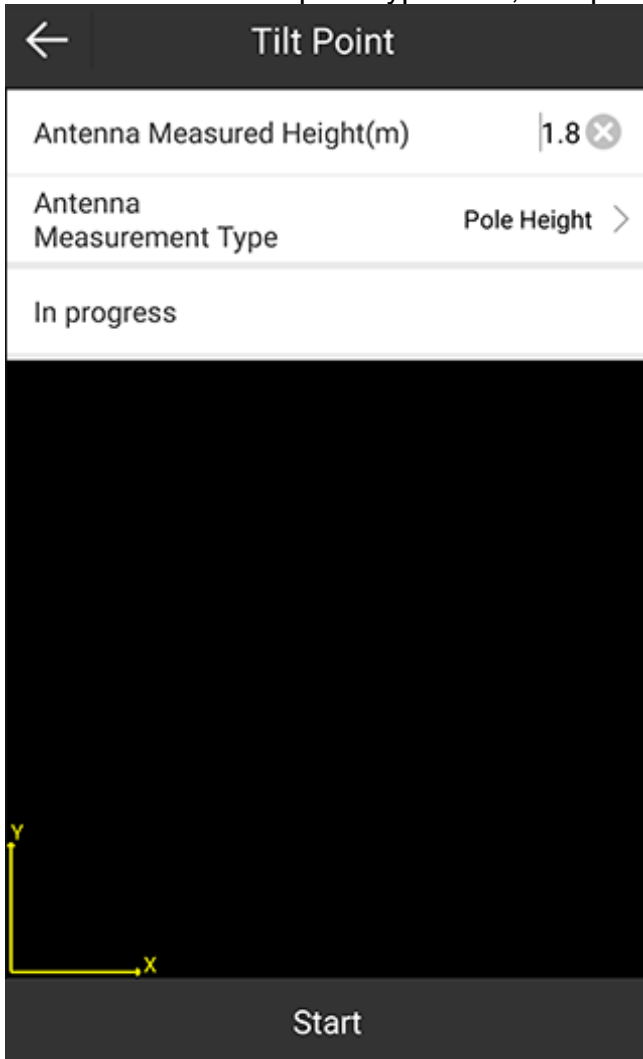

2. **Optional:** To modify antenna parameters, press **Antenna Parameters**, and set antenna parameters.
3. To start collecting tilt points, press **Start**.
4. Incline the pole with the inclined angle greater than 5°. SurPad automatically collects the first tilt point.

5. Change the inclined direction and repeat step 4 until 3 tilt points are collected. After 3 tilt points are collected, the following interface shows:

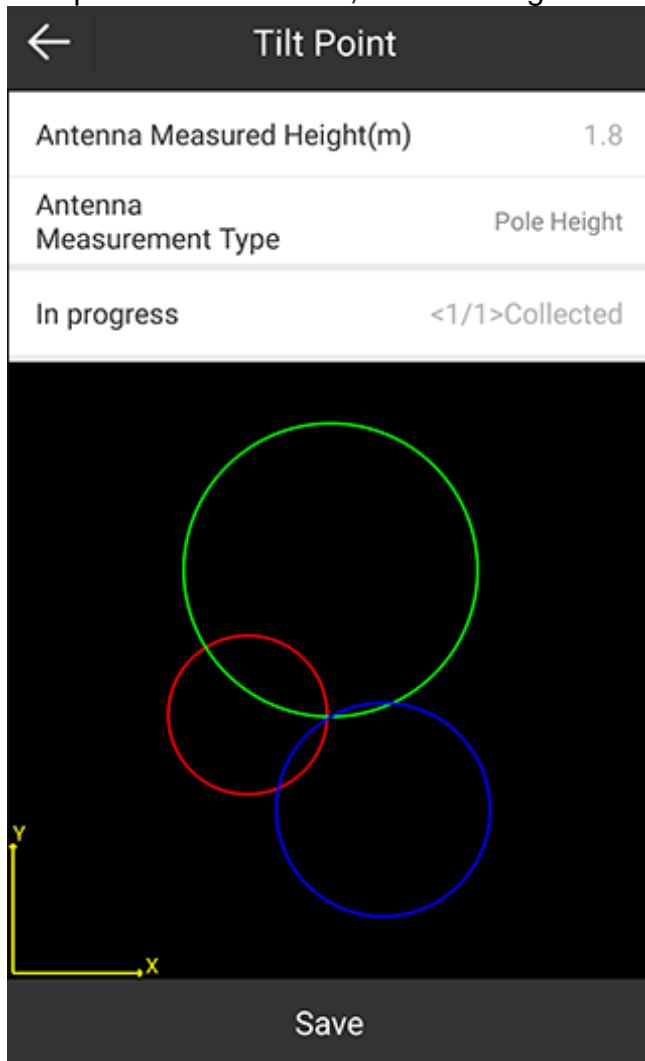

6. To save the result, press **Save**. The following interface shows:

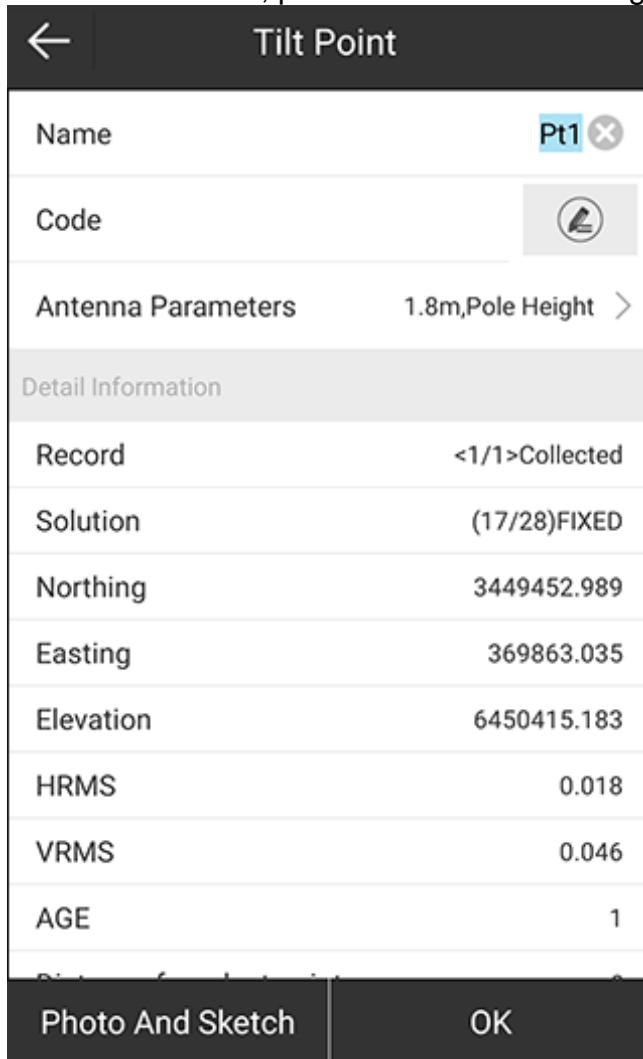

7. Press **OK**.

5.2 Detail Survey

It is a simplified mode of point survey for rapid and continuous survey.

To start detail survey, do the following:

1. Press main menu **Survey** → **Point Survey** to enter the following interface:

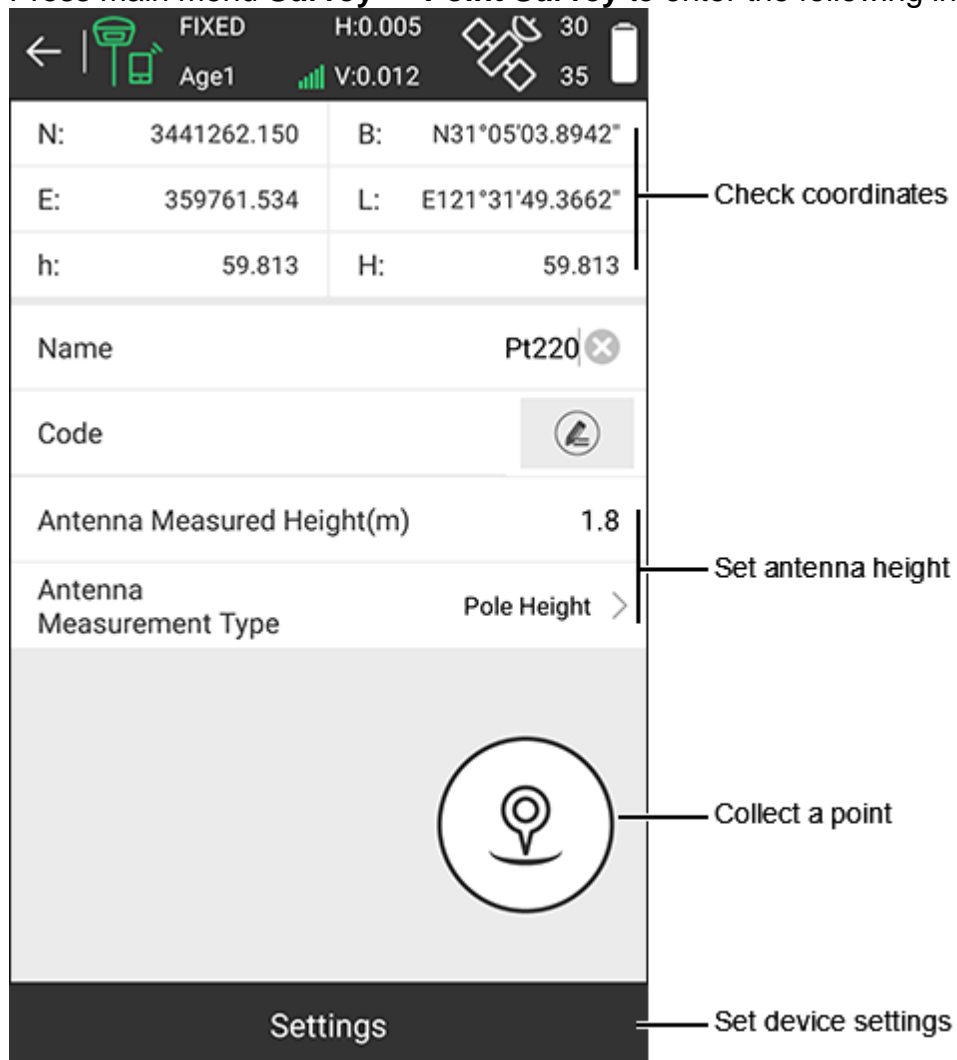

2. Set point name, code and antenna height.

3. **Optional:** Set device settings:
- a. Press **Settings**. **Device Settings** interface shows:

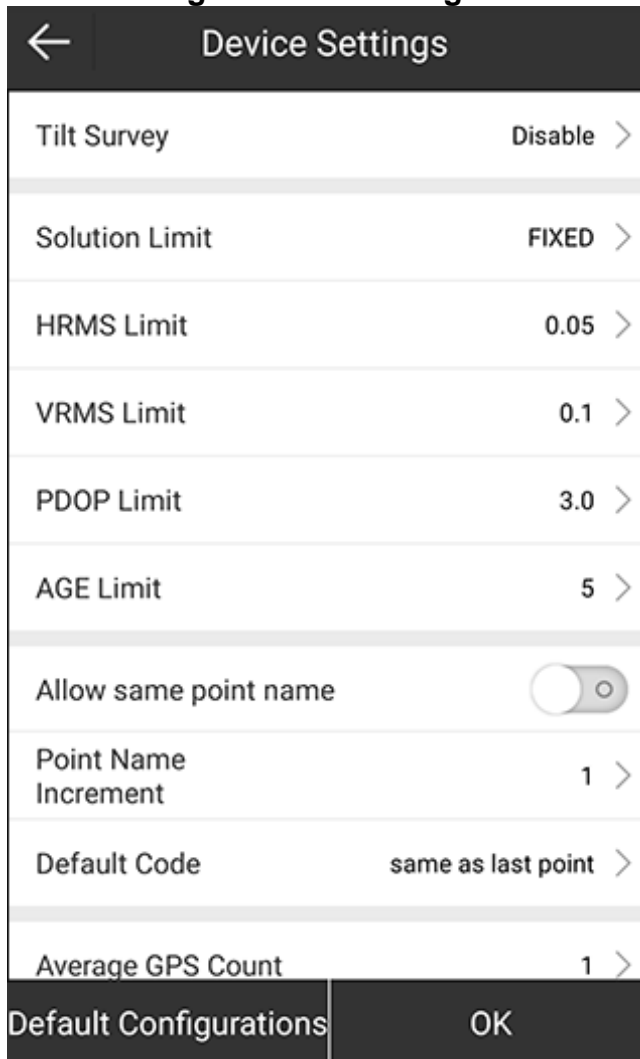

- b. Select whether to enable tilt survey.
- c. Set recording limit, including solution limit, HRMS limit, VRMS limit, PDOP limit, and AGE limit.
- d. Select whether to allow the same point name, and set the increment of the point name, and default code.
- e. Select the average GPS count.
- f. Press **OK**.

4. To collect a point by detail survey, press



5.3 CAD

It is mainly used to import and edit the existing CAD graphics and stakeout in the existing CAD graphics.

Press **Survey** → **CAD** to enter **CAD** interface:

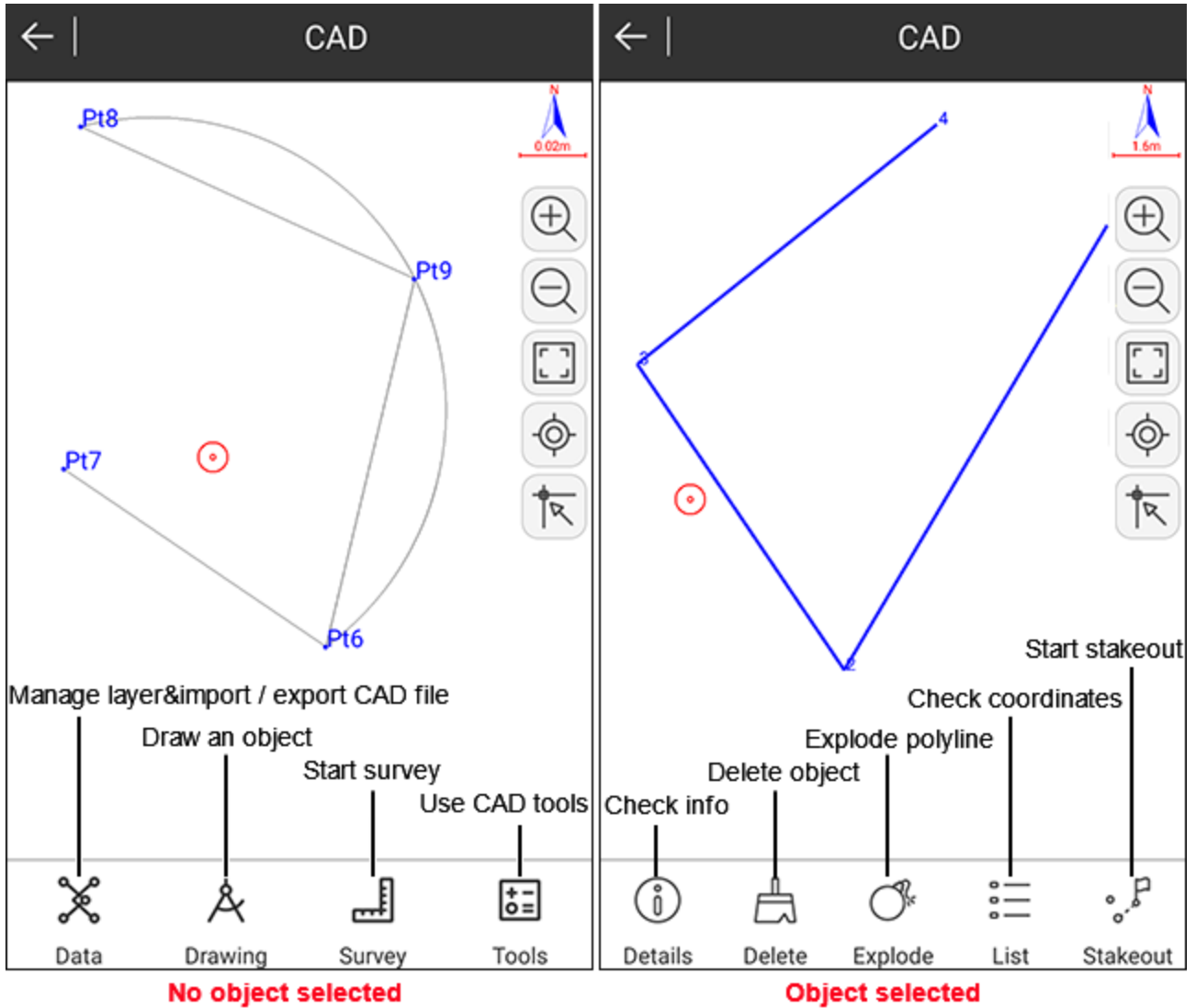

5.3.1 Manage the Layer

To manage the layer, do the following:



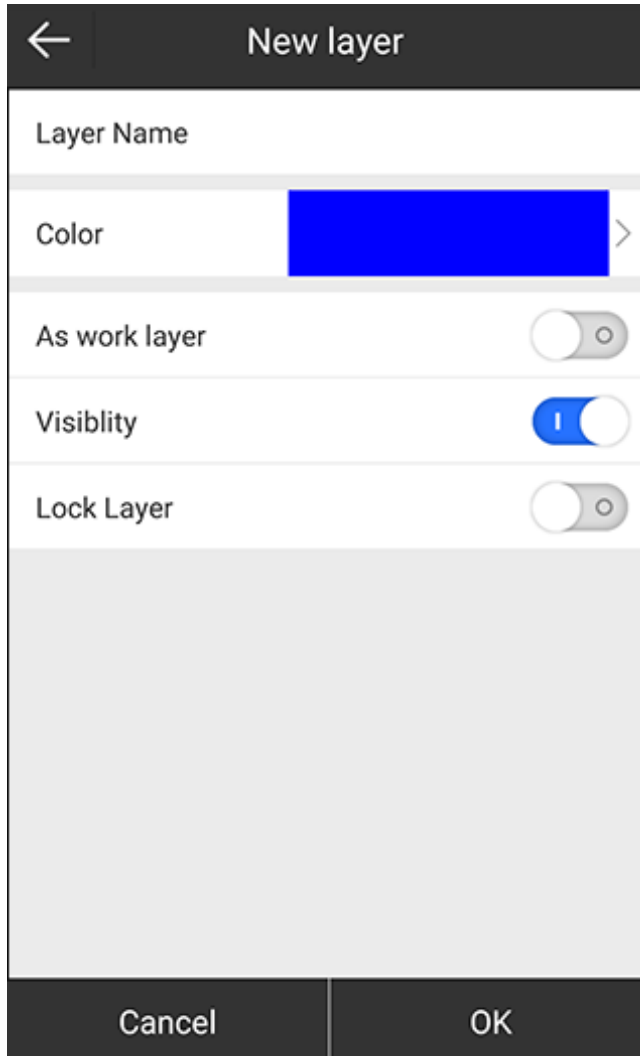



1. To add a new layer, do the following:
 - a. To enter **New Layer** interface, press **Data** → **Layer**, and press **NEW LAYER**:

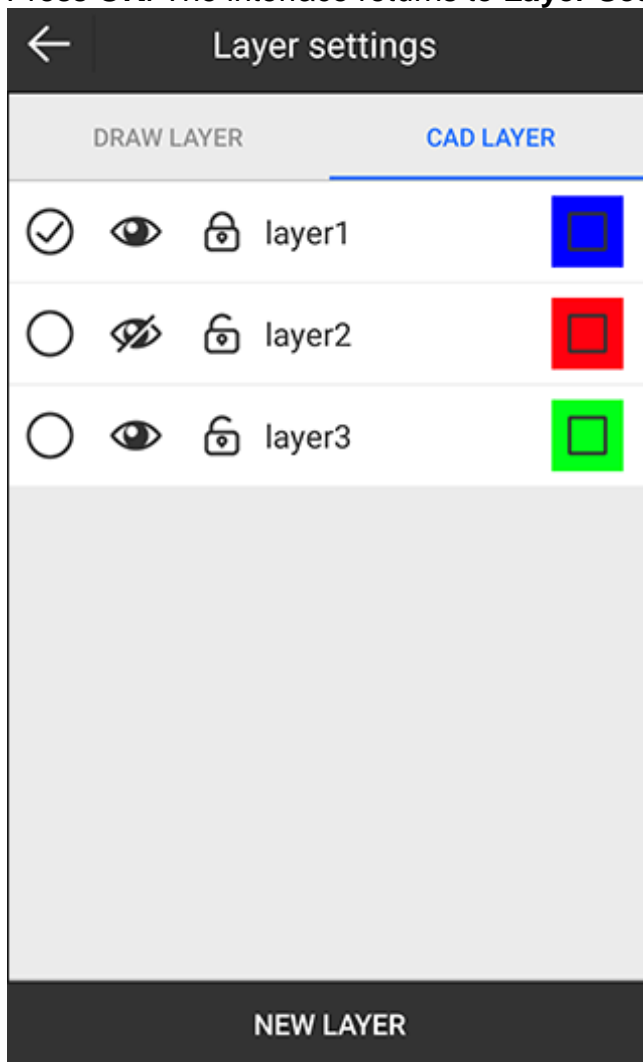





- b. Input the layer name and set the layer color.
- c. Select the following:
 - Whether to set the layer as the work layer.
 - Whether the layer is visible.
 - Whether to lock the layer.

2. Press **OK**. The interface returns to **Layer Settings** interface:



Icons	What it means
	The layer is the work layer.
	The layer is not the work layer.
	The layer is visible.
	The layer is not visible.
	The layer is locked. In the lock status, you cannot select objects of the locked layer.
	The layer is unlocked.

3. **Optional:** Do the following based on your needs:

- To rename the target layer, select the target layer, long press it, select **Rename**, and set the layer name.
- To hide all layers, long press any layer, select **Hide all**. Icon  shows. All layers become invisible.
- To modify the current work layer, press  .  shows.
- To modify the lock status, press  to unlock the target layer, and press  to lock the target layer.
- To modify the layer color, press the color of the target layer, and select a color again.

5.3.2 Import / Export a CAD File

CAD files refer to DXF and DWG files.

To import / export a CAD file, do one of the following:

- To import a CAD file, do the following:
 - a. Press **Data** → **Open**.
 - b. Select the target file path.
- To export a CAD file, do the following:
 - a. Press **Data** → **DXF export**. **DXF export** interface shows:

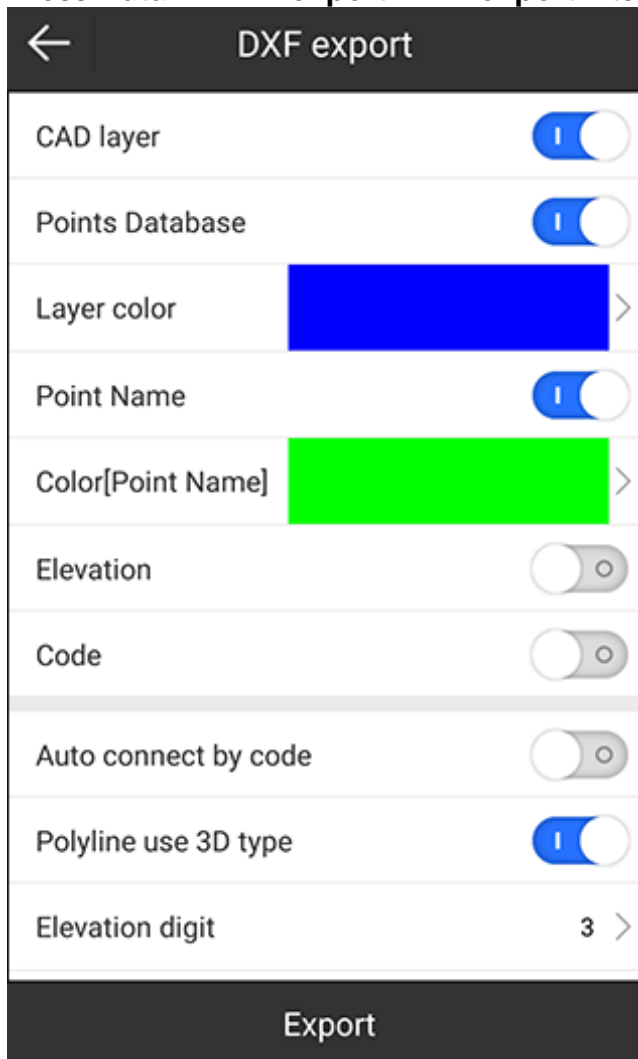

- b. Select the information that you would like to export.
- c. Press **Export**.

5.3.3 Draw an Object

To draw an object, do the following:

1. Press **Drawing**. The following interface shows:

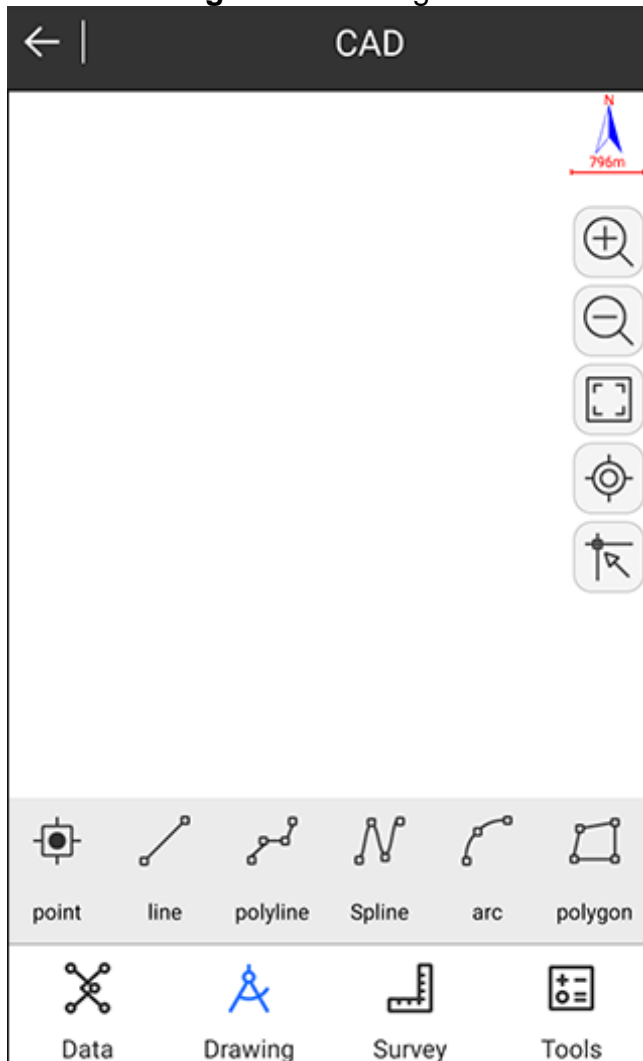

2. Select a shape. The following interface shows:

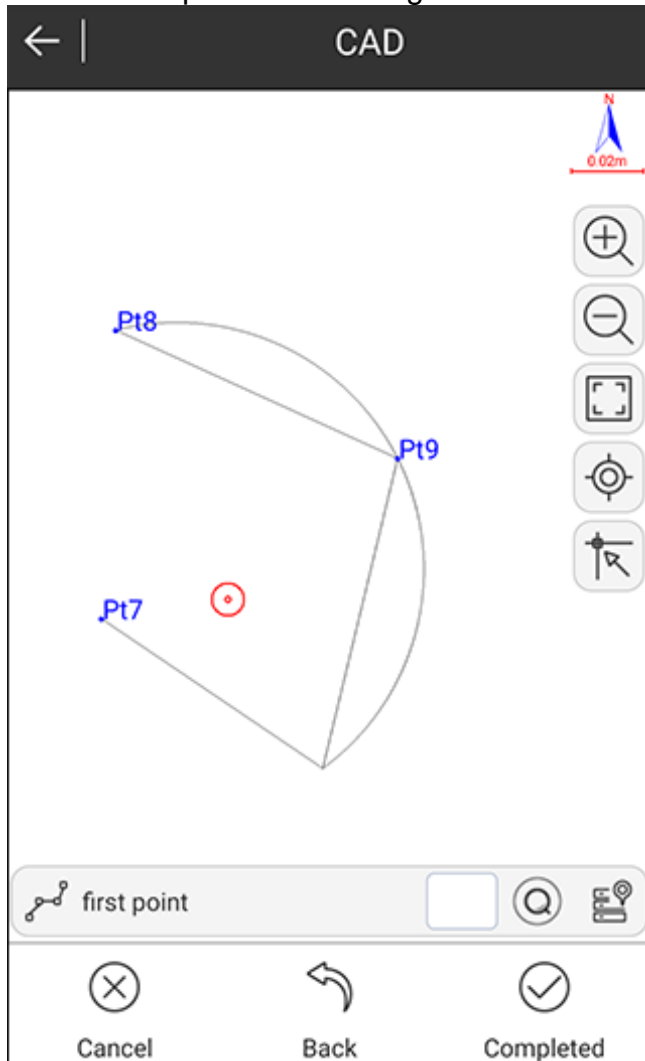







3. Follow tips at the bottom.
4. After finishing, press **Completed**.

5.3.4 Start Survey

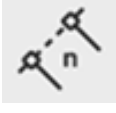
It is used to find the intersection point, perform distance offset, division, intersection, lengthening, etc.

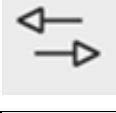
Tools		What it does
	Int 2 dist	To define an intersection by two point and two distance.
	Int 4 point	To define an intersection by two intersecting lines drawn by four points.
	Int entity	To define an intersection from object(s).

Tools		What it does
	Point offset	To define an offset point by a point on the object and offset distance.
	Dist offset	To copy the object to the set distance.
	Divide	To divide the object by the input number of partitions.
	Measure	To divide the object by the input fractional length.
	Invert	To invert the order of target point names on an object.
	Lengthen	To lengthen the object from the endpoint.

To start survey, do the following:



1. Press **Survey**, and select a survey mode. The following interface shows (taking **Dist offset** as an example):







2. Follow tips at the bottom.
3. After finishing, press **Completed**.

5.3.5 Use CAD Tools

With CAD tools, you can achieve the following:

Tools		What it does
	Delete	To delete the target object.
	Angle	To calculate angle.
	Distance	To calculate points by distance.

Tools		What it does
	Area	To calculate area.
	CAD background color	To modify CAD background color.
	Redraw	To refresh the current displayed data.
	Current position	To show coordinates of the current position.

To use CAD tools, do the following:

1. Press **Tools**, and select the target tool.
2. Follow tips at the bottom.
3. Press **OK**.

5.3.6 Delete CAD Data

To delete CAD data, do one of the following:

- Select the target object in the drawing window, and press **Delete**:

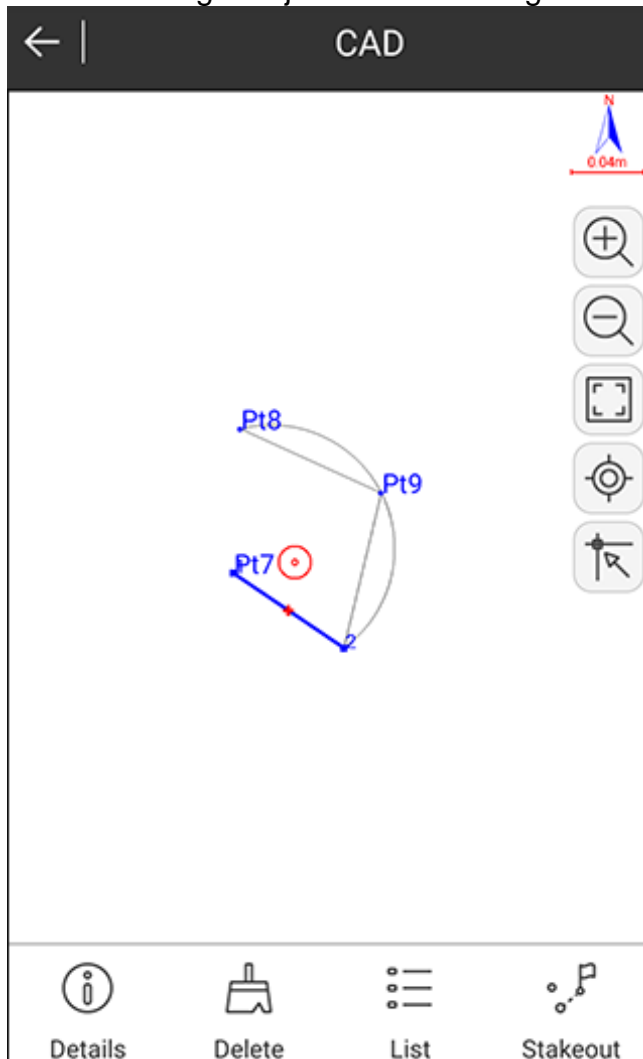



- Press **Tools** →  **Delete**, select the target object, and press **OK**.

5.3.7 Check Object Information

To check object information, do the following:

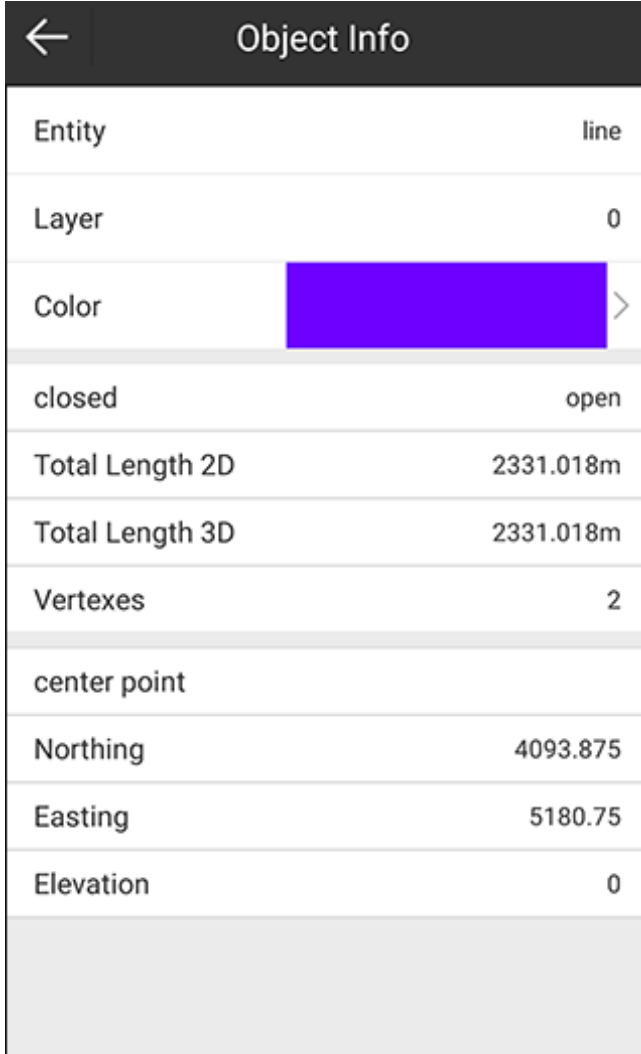
1. Select the target object in the drawing window, and press **Details. Object Info** interface shows:



Object Info	
Entity	line
Layer	0
Color	
closed	open
Total Length 2D	2331.018m
Total Length 3D	2331.018m
Vertexes	2
center point	
Northing	4093.875
Easting	5180.75
Elevation	0

2. **Optional:** To modify the color of the target object, press **Color**, and select the target color:



3. Check the following information:
 - Entity
 - Layer
 - Color

- Object type: open or closed
- Total length 2D and 3D
- Vertexes
- Coordinates of the center point

5.3.8 Explode a Polyline

It is used to explode a polyline into several lines.

To explode polylines, select the target polyline in the drawing window, and press **Explode**.

5.3.9 Check Coordinates

It is used to check coordinates of the target object, and modify the point name, or start stakeout.

To check coordinates, do the following:

1. Select the target object in the drawing window, and press **List**. The following interface shows:

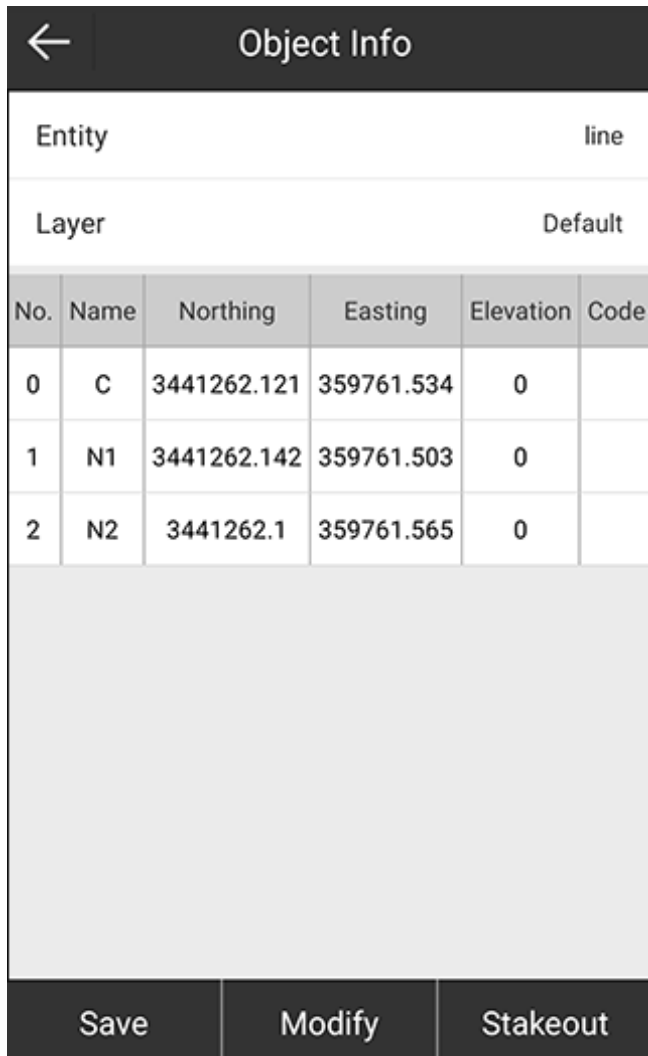

Object Info					
Entity					line
Layer					Default
No.	Name	Northing	Easting	Elevation	Code
0	C	3441262.121	359761.534	0	
1	N1	3441262.142	359761.503	0	
2	N2	3441262.1	359761.565	0	

Save Modify Stakeout

2. **Optional:** To modify point name, select the target point, press **Modify**, and modify the name.
3. **Optional:** To start stakeout, select the target point, and press **Stakeout**.
4. Check coordinates of the target object (including center point).

5.3.10 Start Stakeout

To start stakeout, do the following:

1. Select the target object, and press **Stakeout**. **Stakeout Settings** interface shows:

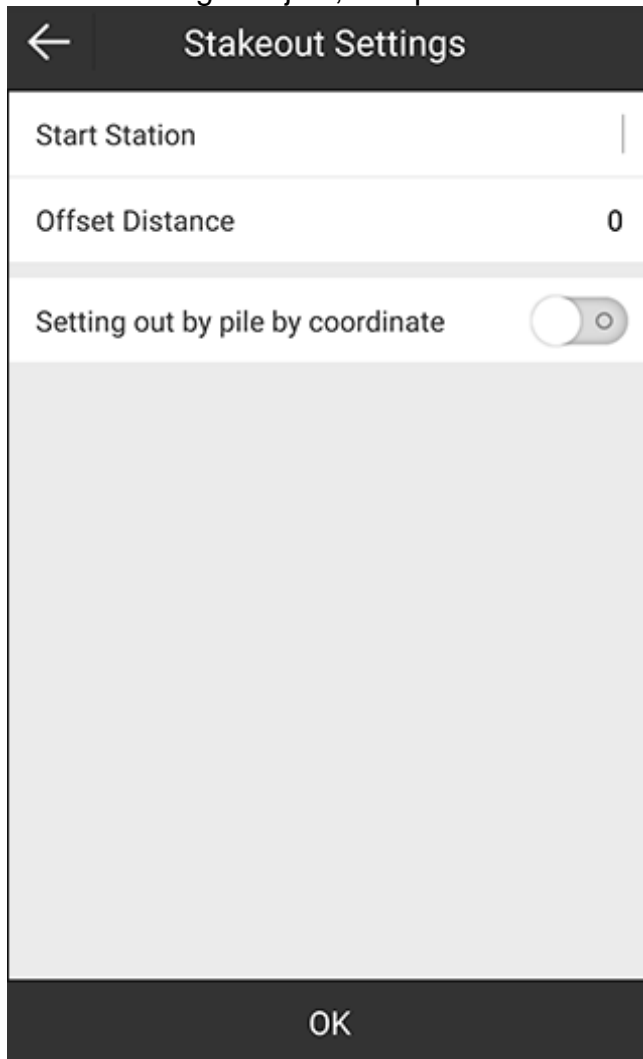

2. Set the start station and offset distance, and select whether to set out by pile by coordinate.
3. Press **OK**, and perform stakeout.
See [5.4](#) Point Stakeout for details.

Alternatively, you can start stakeout for points by pressing **List**, select the target point and press **Stakeout** in **Object Info** interface:

Object Info					
Entity					line
Layer					Default
No.	Name	Northing	Easting	Elevation	Code
0	C	3441262.121	359761.534	0	
1	N1	3441262.142	359761.503	0	
2	N2	3441262.1	359761.565	0	

Save	Modify	Stakeout
------	--------	----------



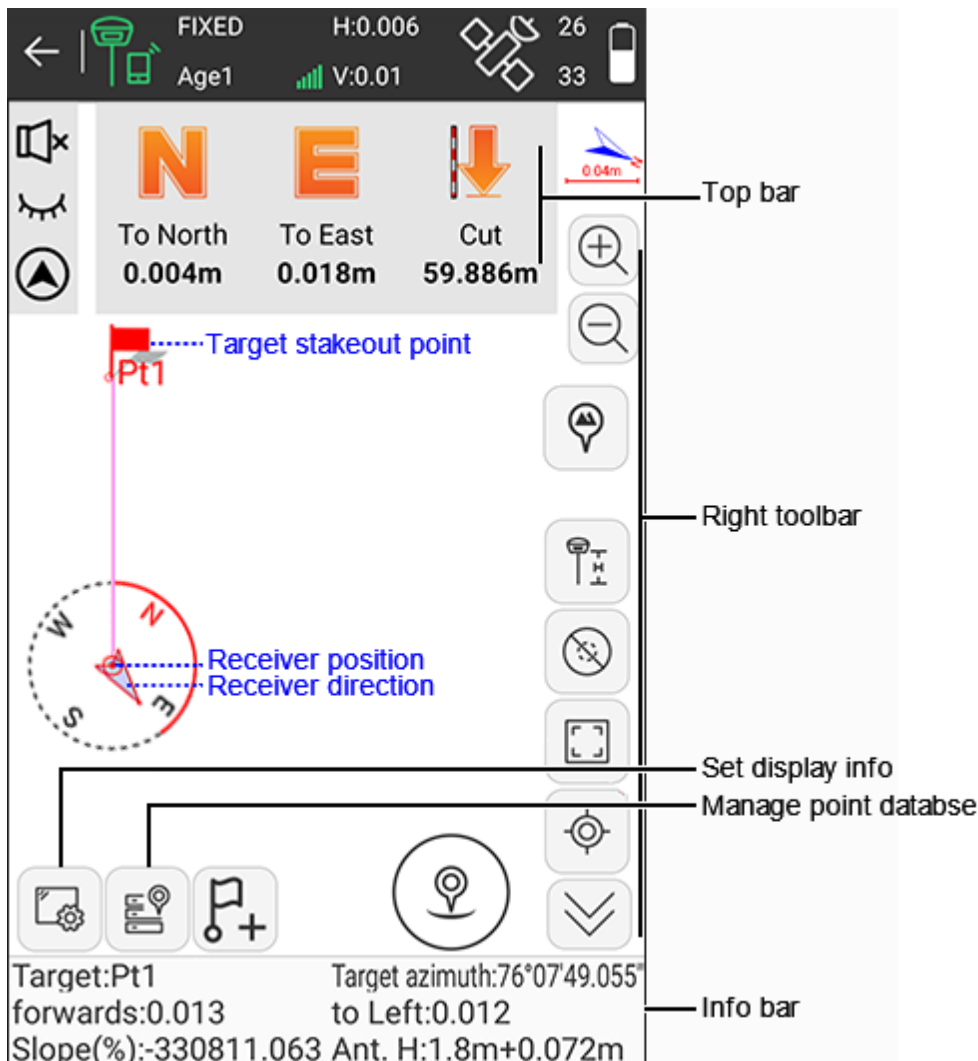

5.4 Point Stakeout

To enter the main interface of point stakeout, press **Survey** → **Point Stakeout**, select a target point or add a new point, and press **OK**:







Top bar

Icons	What it does
N / S	To indicate the distance that the receiver needs to move north / south from the current position to the stakeout point.
E / W	To indicate the distance that the receiver needs to move west / east from the current position to the stakeout point.
↓ / ↑	If the current height is higher than the stakeout point, ↓ shows; if not, ↑ shows.
	To close the voice prompt of stakeout.
	To open the voice prompt of stakeout.

Icons	What it does
	To hide the top bar.
	To show the top bar.
	To switch to the compass mode.
	To switch to the distance mode.

Toolbars

Here only icons different from **Point Survey** main interface are listed. About the same icons, please see [5.1](#) Point Survey for details.

Icons	What it does
	To add a new stakeout point.
	To select the last point for stakeout.
	To select the next point for stakeout.
	To select the point closest to the stakeout point.

Information bar

- **Target:** the name of the stakeout point.
- **Target Azimuth:** the azimuth from the current point to the target position.
- **Forwards / Back:** the distance that the receiver needs to move forwards / back from the current position to the stakeout point.
- **To Left / To Right:** the distance that the receiver needs to move left / right from the current position to the stakeout point.
- **To North / To South:** the distance that the receiver needs to move south / north from the current position to the stakeout point.
- **To East / To West:** the distance that the receiver needs to move east / west from the current position to the stakeout point.
- **Slope(%):** the ratio of the vertical length to the horizontal length.
- **Ant.H:** the antenna height in survey.

5.4.1 Manage Stakeout Point Database





To manage stakeout point database, do the following:

1. To enter **Stake Point** interface, do one of the following:
 - Press main menu **Survey** → **Point Stakeout**.

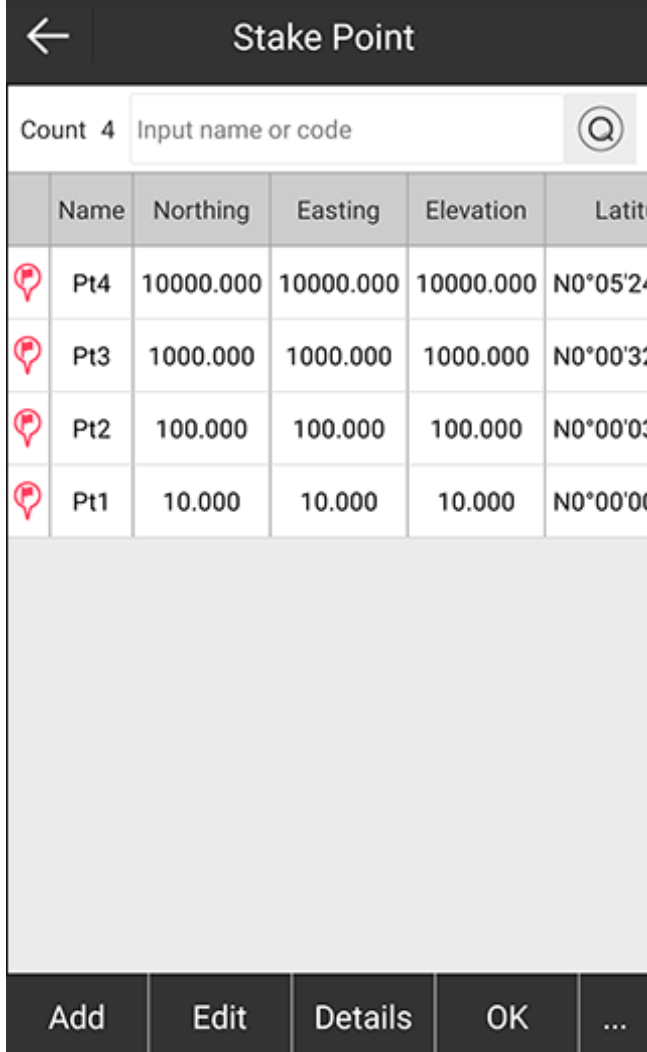

- In the main interface of point stakeout, press



Stake Point					
Count 4 <input type="text" value="Input name or code"/> <input type="button" value="Q"/>					
	Name	Northing	Easting	Elevation	Latitude
	Pt4	10000.000	10000.000	10000.000	N0°05'24"
	Pt3	1000.000	1000.000	1000.000	N0°00'32"
	Pt2	100.000	100.000	100.000	N0°00'03"
	Pt1	10.000	10.000	10.000	N0°00'00"

Add Edit Details OK ...

2. Do the following:
 - Add a new stakeout point.
 - Edit a stakeout point.
 - Check stakeout point information.
 - Import a stakeout point.
 - Delete a stakeout point.
 - Filter a stakeout point.
 - Recover stakeout points.
 - Share a stakeout point.
 - Mark a stakeout point as staked.

The operations are almost the same with operations in **Points Database** interface. See [3.5](#) Point Database for details.

5.4.2 Set Display Information

It is used to customize display information, including stakeout settings, topo point, information bar and toolbars.

To set display information, do the following:



1. In the main interface of line stakeout, press **Display Information** interface shows:

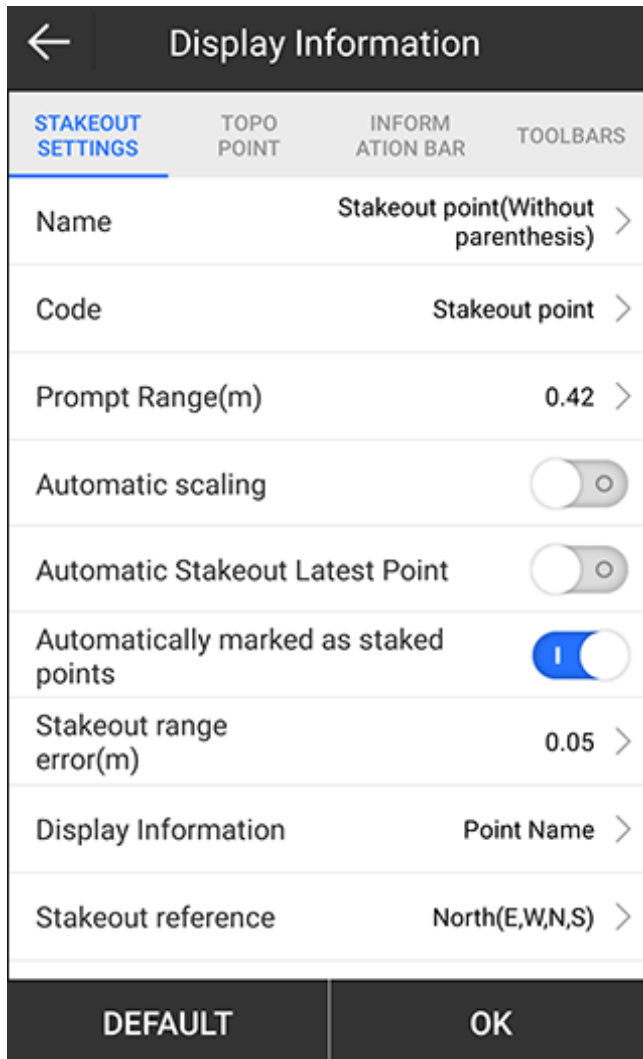

2. Set the following stakeout settings:
 - **Name:** the name of the stakeout point.
 - **Code:** to select a code for the stakeout point.
 - **Prompt range:** to set the target distance triggering precise stakeout.
 - **Automatic scaling:** to select whether to make the figure automatically display in full screen. Once it is enabled, you cannot zoom in / out the figure.
 - **Automatic stakeout latest point:** to select whether to automatically stake out the latest point.
 - **Automatically marked as staked points:** to select whether to automatically mark the selected point as the staked point when the current target distance is less than tolerance.

- **Stakeout reference:** to change the display in the top bar (North (E, W, N, S) or forward direction (front, back, left, right)).
 - **Voice broadcast:** to select whether to enable voice broadcast.
3. Set point limit, information bar and toolbars.
See [5.1.3 Set Display Information](#) in point survey for details.

5.4.3 Start Point Stakeout

To start point stakeout, do the following:

1. To select a point for stakeout, do the following:



- a. Press .
 - b. Select the target point.
 - c. Press **OK** to enter stakeout interface.
2. Move towards the indicated direction according to information in the information bar. When the target distance is within 3 times of the prompt range, three concentric circles shows, which indicates it enters precise stakeout:

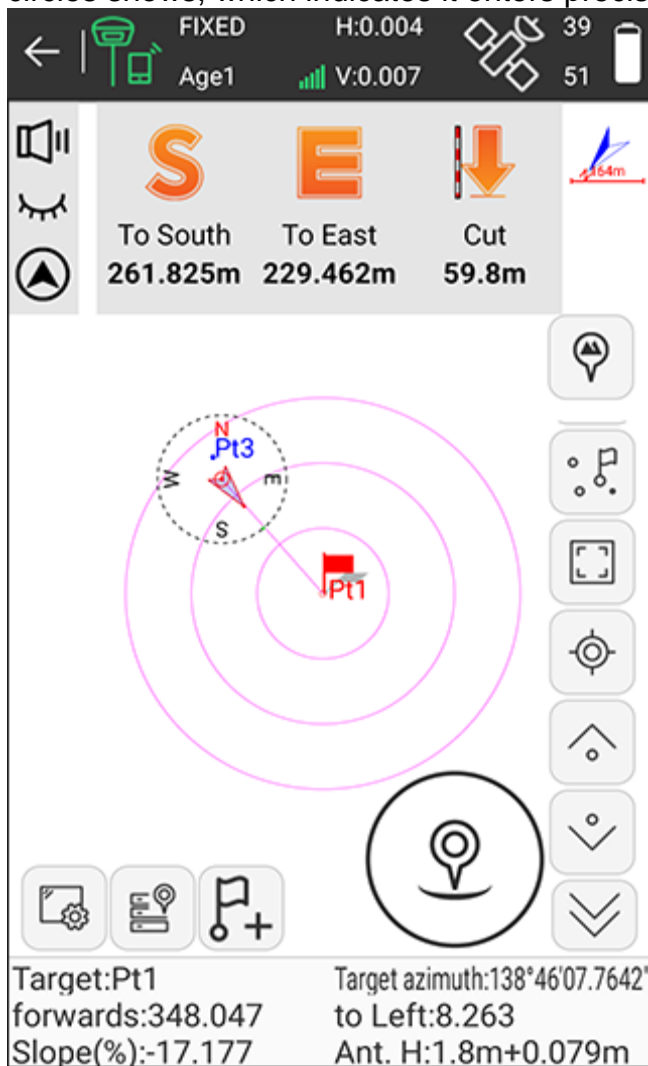

3. **Optional:** To switch between the adjacent stakeout points in the stakeout point

database, press  / .

4. After reaching the stakeout point, stake it.



5. Press ... → **Marked as Staked**. The target point in point stakeout database turns to blue, and a small red flag shows in the staked point in the main interface of point stakeout:

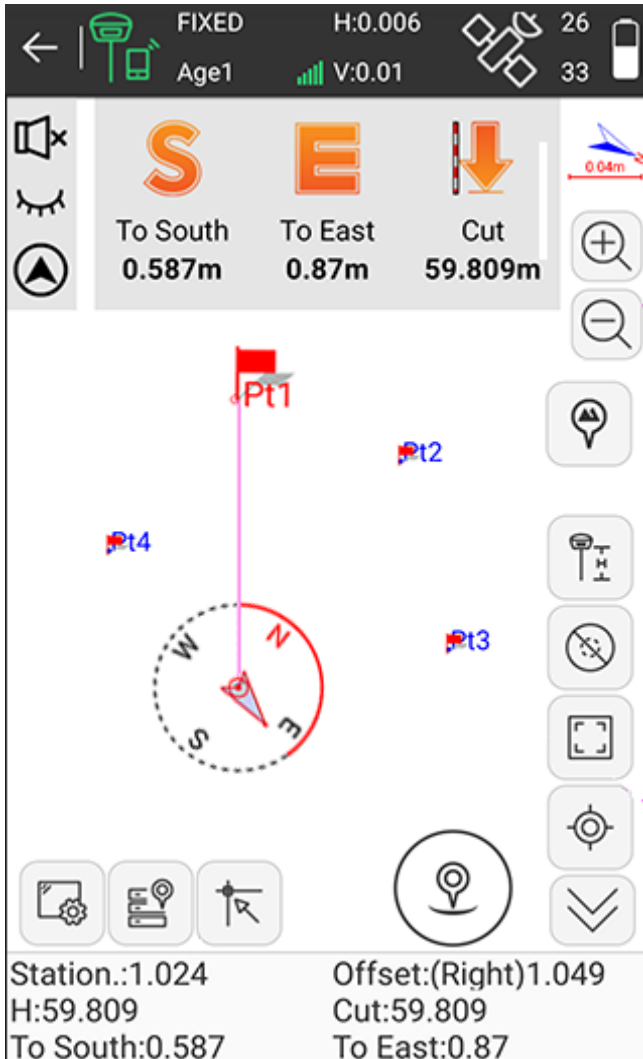

Alternatively, you can enable **Automatically marked as staked points** in display information.

5.5 Line Stakeout

It is the stakeout of the designed line, including line station, left and right offset and elevation control within line.

To enter the main interface of line stakeout, press **Survey** → **Line Stakeout**, select the target line or add a new line, and press **OK**:

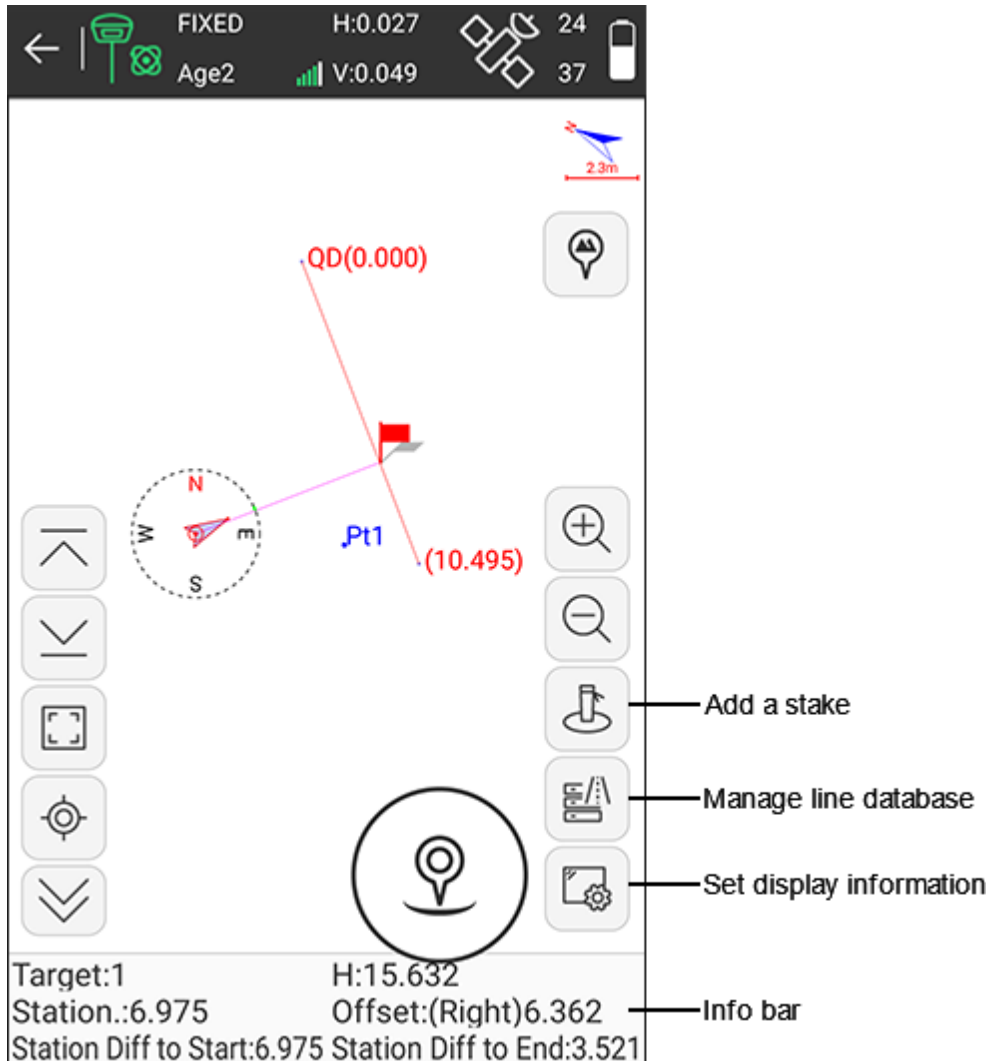

Information bar

- **Target:** the name of the stakeout line.
- **H:** the height of the current point.
- **Station:** making a perpendicular to the stakeout line through the current receiver position, the start station plus the distance between the foot of perpendicular and the start point.
- **Offset:** the perpendicular distance from the current position to the target line.
- **Station Diff to Start:** making a perpendicular to the stakeout line through the current receiver position, the distance from the foot of perpendicular to the start point.
- **Station Diff to End:** making a perpendicular to the stakeout line through the current receiver position, the distance from the foot of perpendicular to the end point.

5.5.1 Manage Line Database

To manage line database, do the following:

1. To enter **Lines Database** interface, do one of the following:
 - Press main menu **Survey** → **Line Stakeout**.



- In the main interface of line stakeout, press

← Lines Database					
No.	Name	Start Station	Length	Azimuth	
1	line1	1.000	0.038	257°47'58.313"	
2	line2	1.038	0.062	43°41'52.9706"	
3	line 3	1.100	0.204	346°06'00.0453"	

Add	Edit	Delete	OK	...
-----	------	--------	----	-----

2. Do the following:
 - Add a new line.
 - Edit a line.
 - Delete a line.
 - Import a line.
 - Export a line.

The operations are almost the same with operations in **Points Database** interface. See [3.5](#) Point Database for details.

5.5.2 Set Stakeout Settings

To set stakeout settings, do the following:

1. To enter **Stakeout Settings** interface, select the target line in line database:

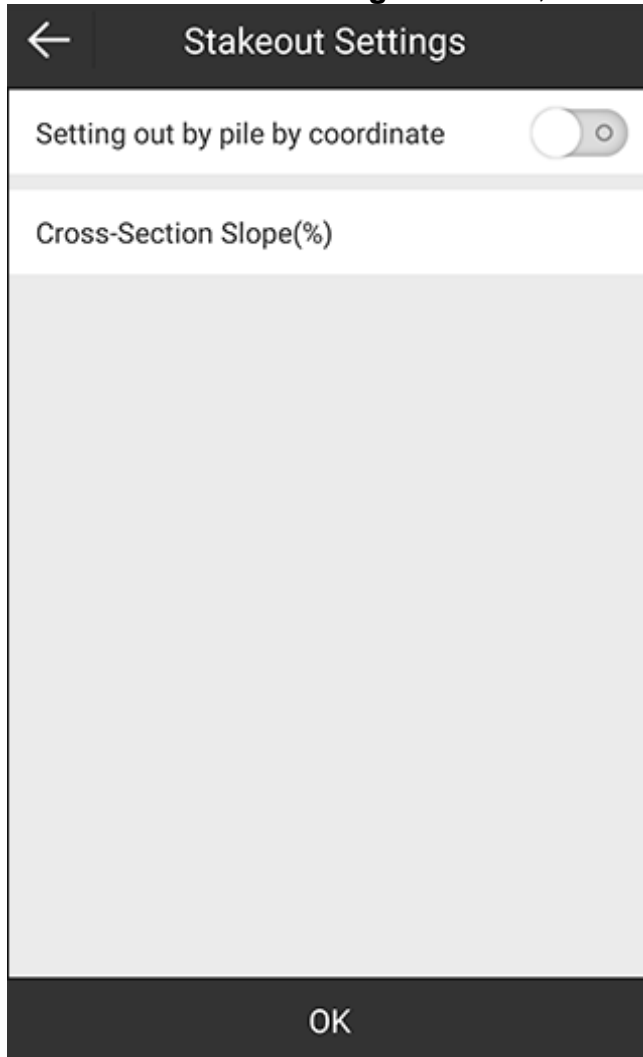

2. Select whether to set out by pile by coordinate.
3. Do one of the following according to your selection that **Setting out by pile by coordinate** is enabled or not:
 - If it is enabled, select whether to automatically stake the latest point, set station, select a calculation mode, and set interval:
Calculation mode:
 - Stakeout by station number: use the start point as the start distance.
 - Stakeout by station distance: use the node as the start distance.
 - Custom mileage offset
 - If it is not enabled, set cross-section slope (%).
4. Press **OK**.

5.5.3 Set Display Information

It is used to customize display information, including stakeout settings, topo point, information bar and toolbars.

To set display information, do the following:



1. In the main interface of line stakeout, press **Display Information** interface shows:

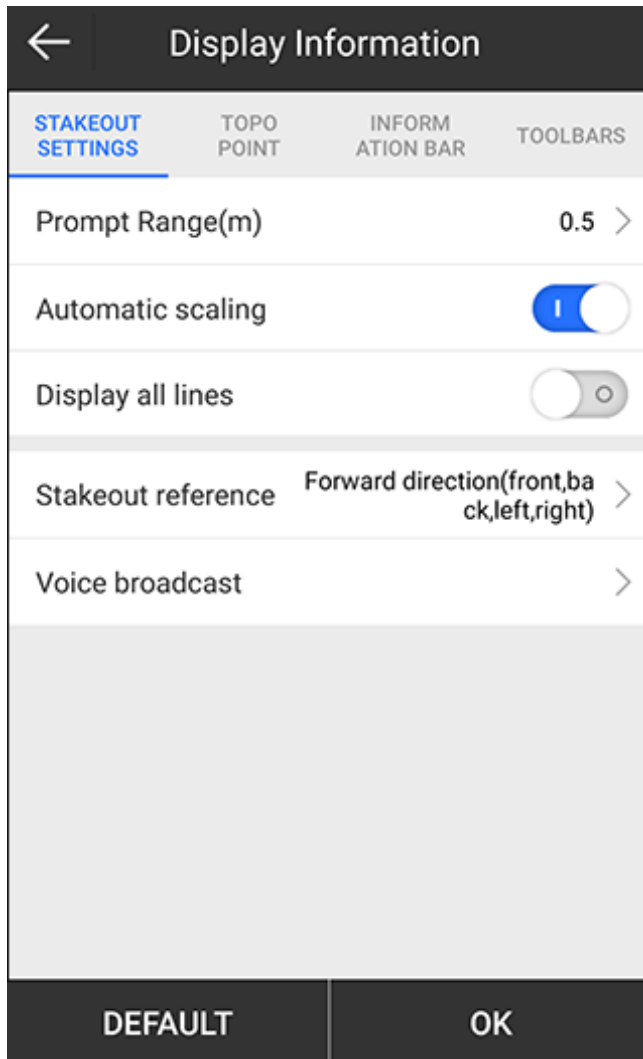

2. Set the stakeout settings, topo point, information bar and toolbars. See [Set Display Information](#) in point stakeout for details.

5.5.4 Add a Stake

To add a stake, do the following:



1. In the main interface of line stakeout, press .
2. Select one of the following modes to add stake:
 - o Calculate coordinates by mileage and offset distance

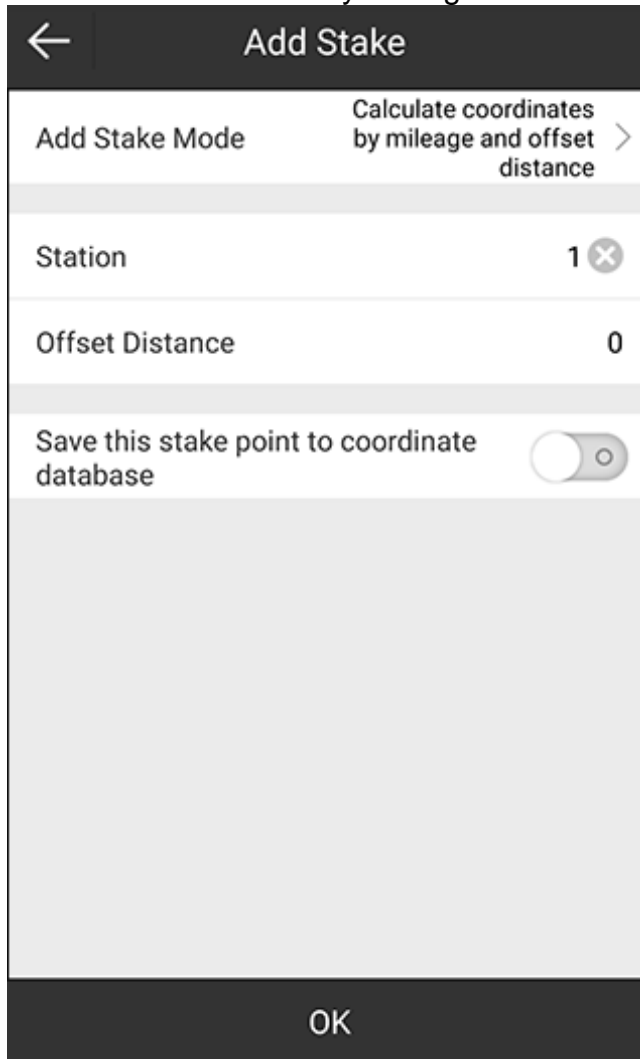

- Calculate offset and distance by coordinates (inputting northing, easting and elevation, search coordinates from the database, or get the current GPS coordinates)

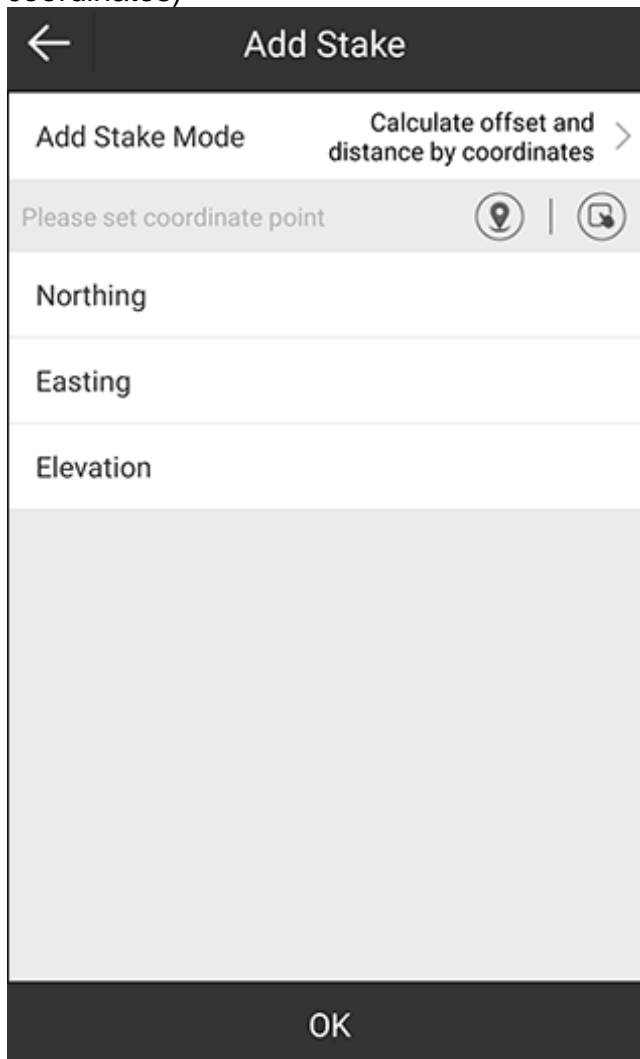

3. Set related parameters.
4. Press **OK**. A prompt about the calculation result shows:

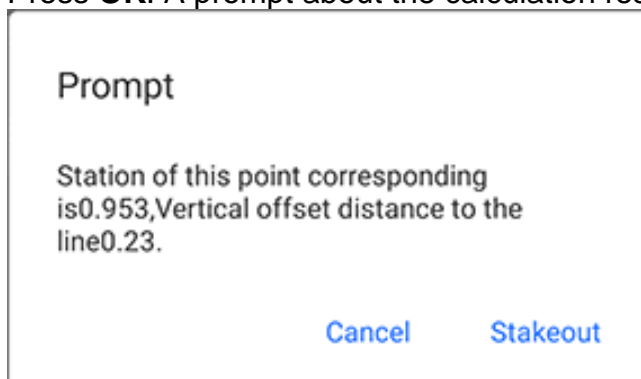

5. Press **Stakeout** to start line stakeout.

5.5.5 Start Line Stakeout

To start line stakeout, do the following:

1. According to the engineering design, edit the stakeout line in the line database or import a line file.
2. Select the target stakeout line and press **OK** to enter line stakeout interface.
3. Move towards the indicated direction according to information in the information bar. When the line offsets on both sides are within 3 times of the prompt range, three parallel lines are generated on both sides of the stakeout line, which indicate it enters precise stakeout:

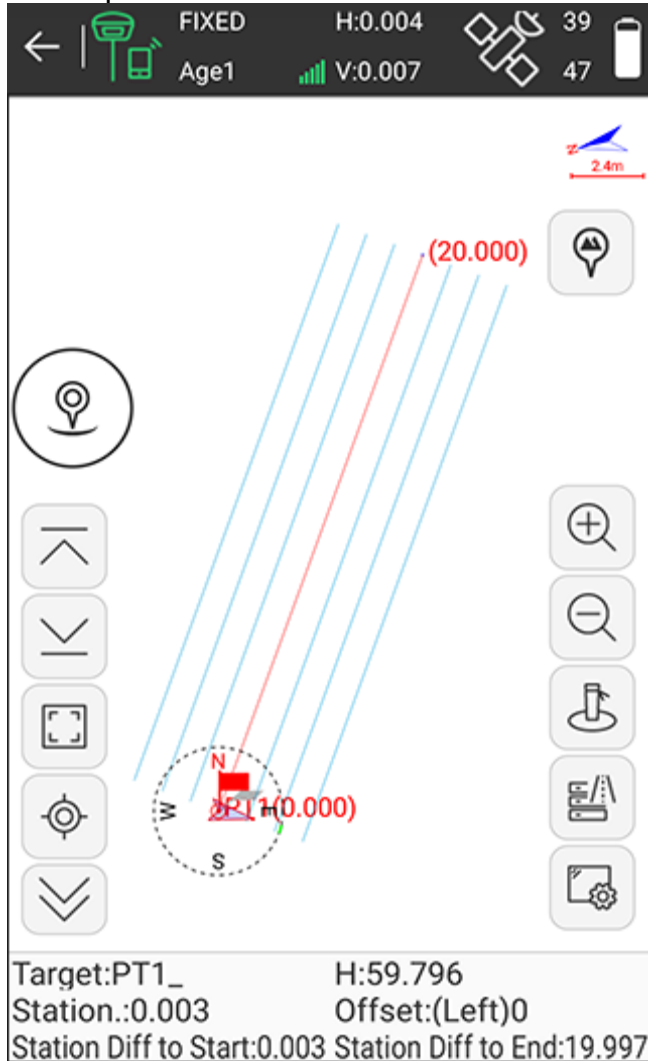

- Optional:** To add a stake to the line during stakeout process, see [5.5.4 Add a Stake](#) for details.

When the target distance is less than 3 times of the prompt range, the system will take the stake point as center and generate prompt circles to get into precise stakeout:

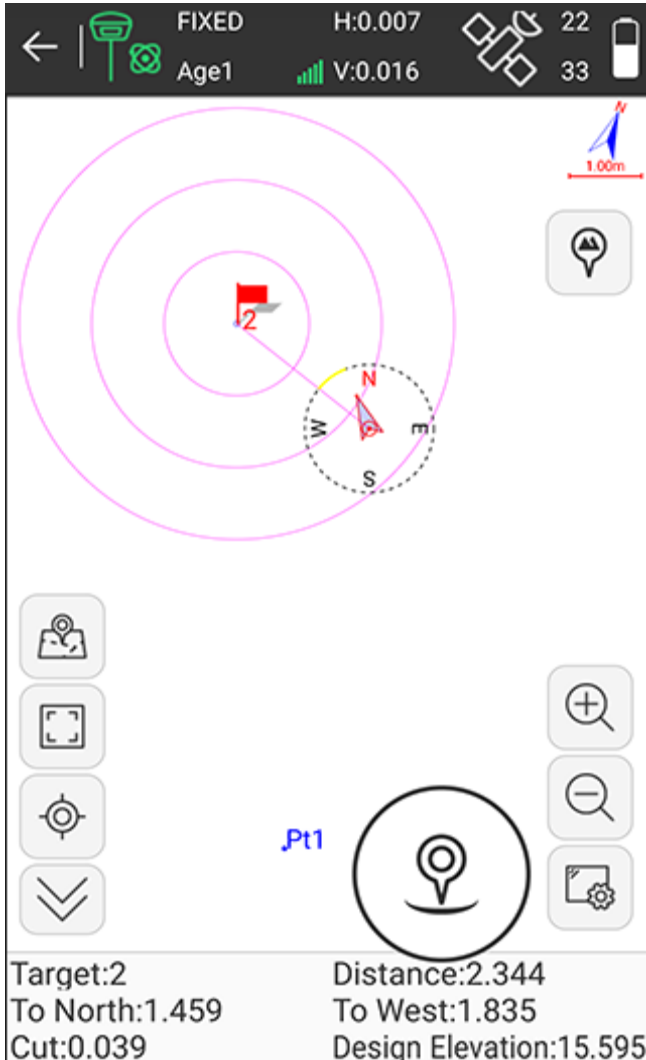

- Optional:** To switch the adjacent stakeout lines in line database, press  or



- After reaching the stakeout line, stake it.

5.6 GIS Data Collection

It is used to mark surface features and add labels to them.

The type of a mark surface includes the following:

- Point
- Polyline
- Polygon

Press **Survey** → **GIS Data Collection** to enter the main interface of GIS data collection:



5.6.1 Add an Entity Element

To add an entity element, do the following:

1. To enter **Entity Element Management** interface, press

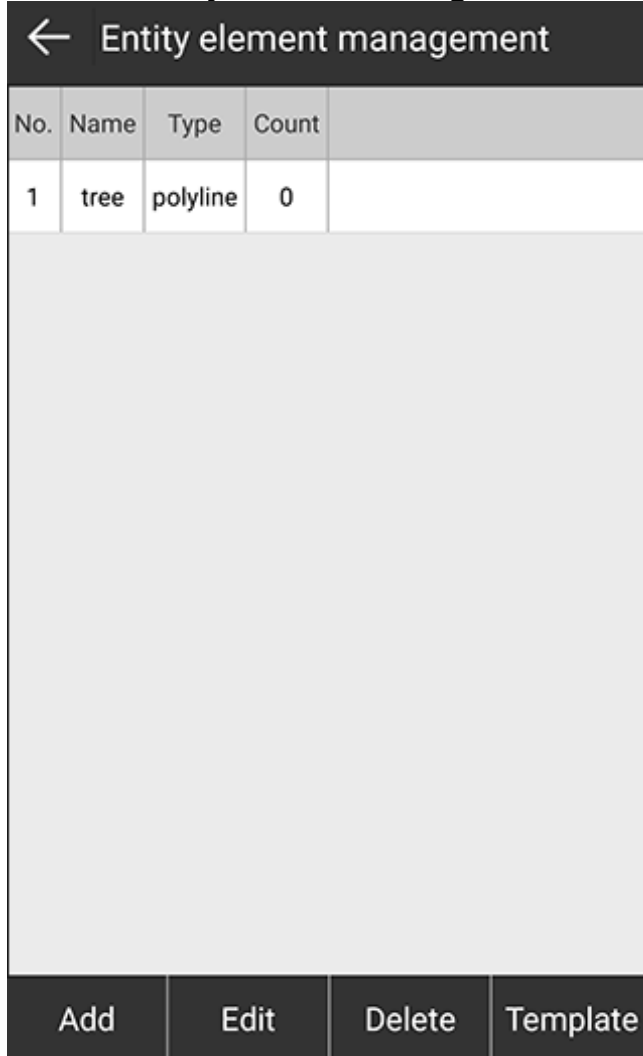
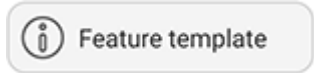

2. To enter **Entity Edit** interface, press **Add**:

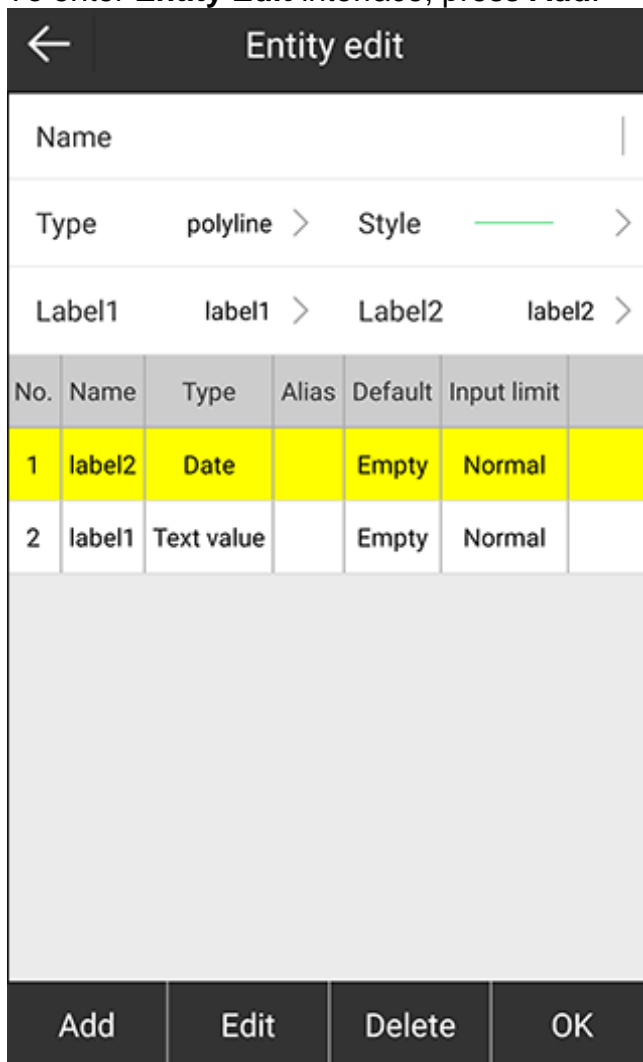

No.	Name	Type	Alias	Default	Input limit
1	label2	Date		Empty	Normal
2	label1	Text value		Empty	Normal

3. Set an entity name.
 4. Select a type of the surface feature, and select a style.

5. To set label 1 and label 2, do the following:
 - a. To enter **Field Edit** interface, press **Add**:

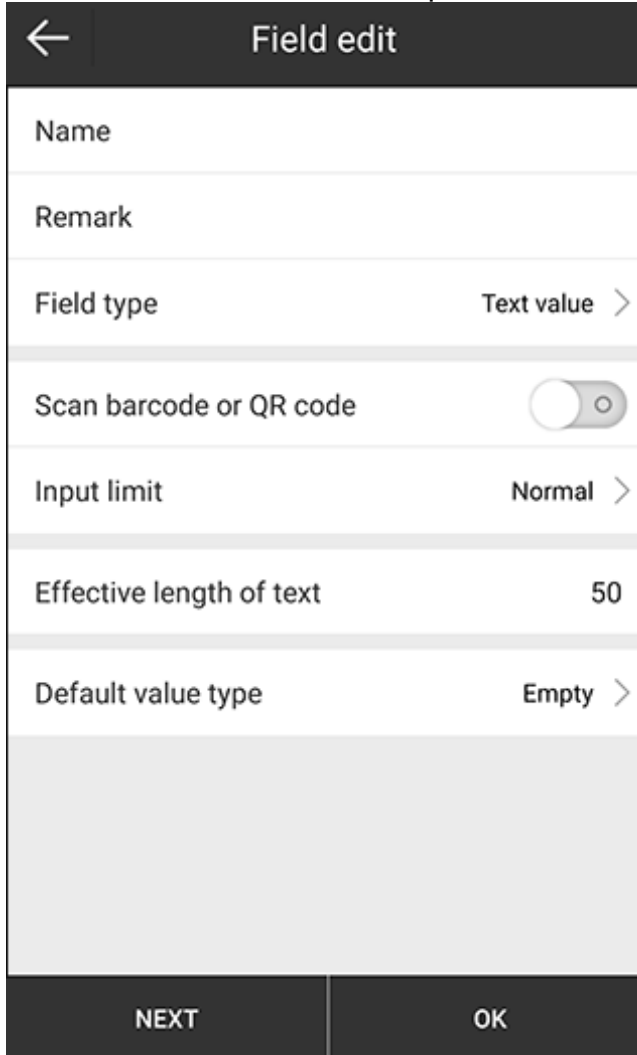



- b. Set a label name, remark.
 - c. Select a field type (including integer value, double value, text value, drop-down menu, check box, date, time and file).
 - d. Select whether to scan barcode or QR code.
 - e. Select a input limit:
 - **Normal**: when the label name is deleted, name will default to 0.
 - **Required**: name is required.
 - **Disabled**: name is unchangeable.
 - **Hide**: the label is hidden in the main interface of **GIS Data Collection**.
 - f. Select the default value type.
 - g. Select the target filed for label 1 and label 2.

The interface returns to **Entity Element Management** interface.
6. Select the target entity element, and press ← to return to the main interface.

5.6.2 Start GIS Data Collection

To start GIS data collection, do the following:

1. In the main interface of GIS data collection, select a point type, select the target surface feature and draw it.
2. To set label details, do one of the following:
 - Press , set the property and press **Save**.
 - Press , set the property and press **Save**.
In this way, you cannot edit label details once you have saved them.

5.7 Stake Road

It is used for stakeout of road, hydraulic engineering, and slope construction.

To enter the main interface of road stakeout, press **Survey** → **Stake Road**, and add a new road stakeout:

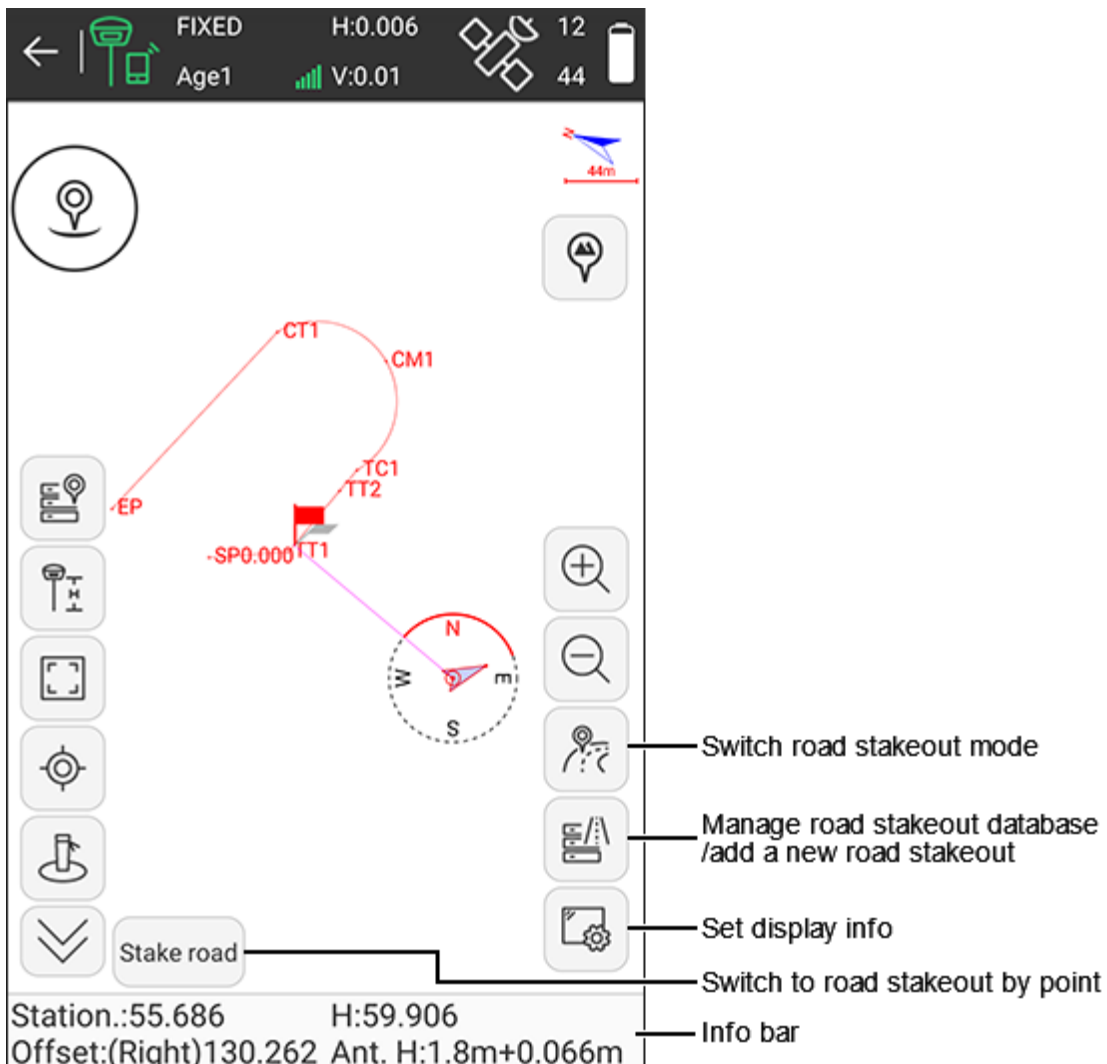

Information bar

- **Station:** making a perpendicular to the stakeout line through the current receiver position, the start station plus the distance between the foot of perpendicular and the start point.
- **H:** the height of the current point.
- **Offset:** the perpendicular distance from the current position to the target line.
- **Ant.H:** the antenna height in survey.

5.7.1 Add a New Road Stakeout

To add a new road stakeout, do the following:

1. Press **New. Road Design** interface shows:

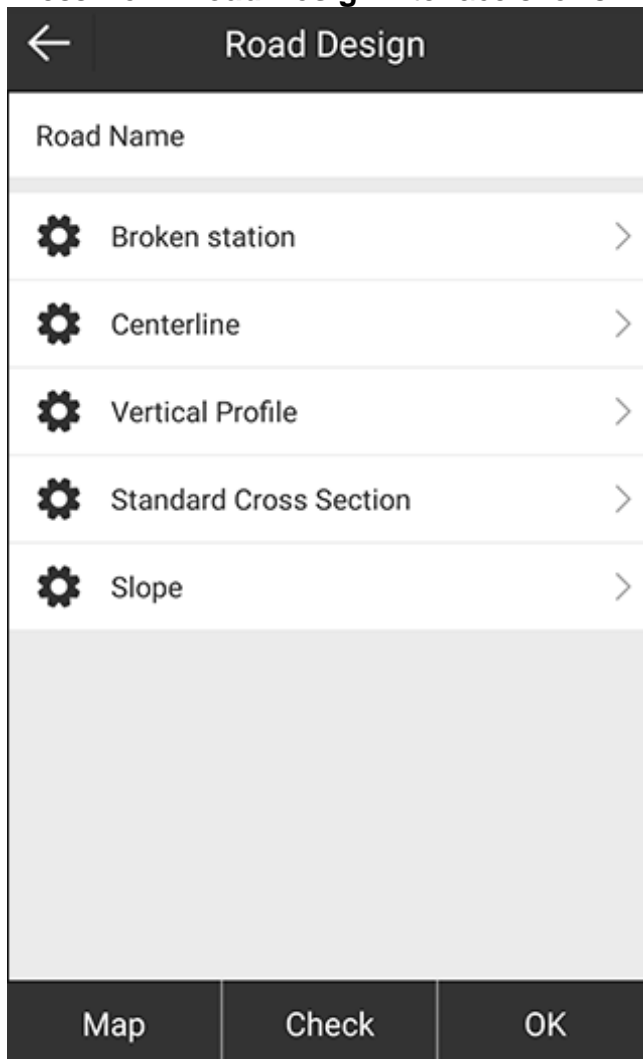

2. Set the road name.

3. Do the following:

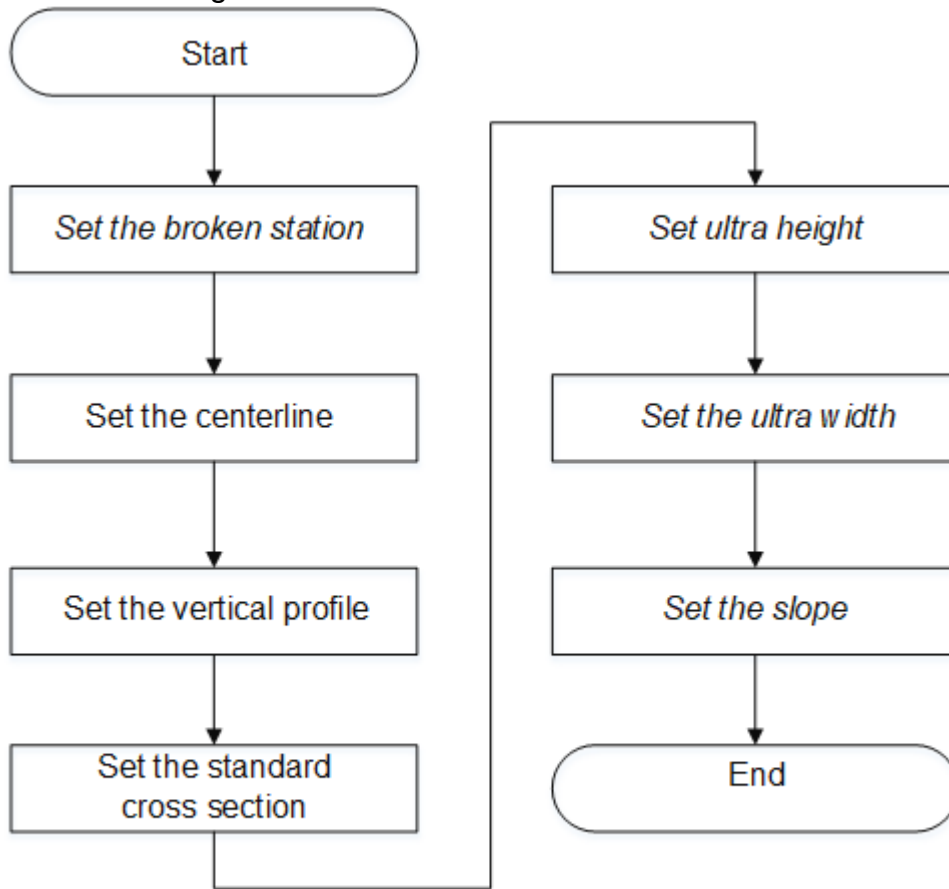

CAUTION: Operations in *Italic* are optional.

4. **Optional:** To preview the road design, press **Map**.

5. **Optional:** To check the road design, press **Check**, and do the following:

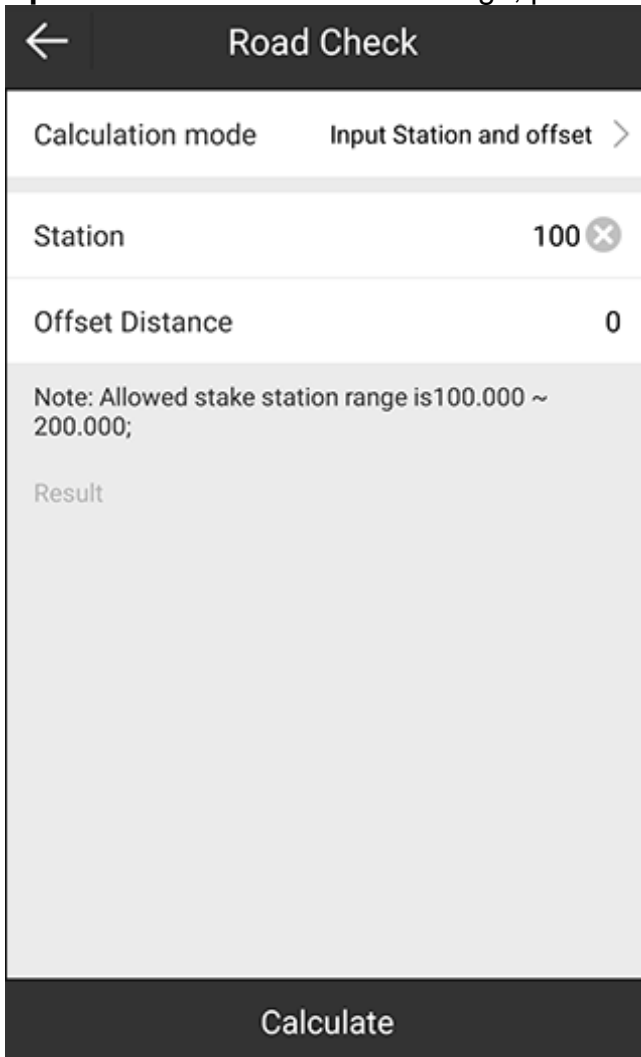

← Road Check

Calculation mode Input Station and offset >

Station 100 ×

Offset Distance 0

Note: Allowed stake station range is 100.000 ~ 200.000;

Result

Calculate

- a. Select a calculation mode:
 - **Input station and offset**
 - **Input coordinate**
 - **Batch export**
 - **Batch counter calculation**
- b. Set station and offset distance.

c. Press **Calculate**. The result shows in **Result** area:

Road Check	
Calculation mode	Input Station and offset >
Station	100
Offset Distance	30 ✕
Note: Allowed stake station range is 100.000 ~ 200.000;	
Result	
Northing	100
Easting	130
Design Elevation	60
Road Design Elevation	60
Azimuth	0°00'00"
Width(Left section)	20
Calculate	

5.7.1.1 Set the Broken Station

It is used to allow broken station without changing all stations when measurement is incorrect or the design changes. That is, you can use new station in the changing place and still old station in other places.

To set the broken station, do the following:

1. To enter **Broken Station**, press **Broken station**:

Broken station					
No.	Type	Length	Before station	After station	
1	Long	0	0.000	0.000	
2	Short	9	1.000	10.000	

Add	Edit	Delete	OK
-----	------	--------	----

2. To add a broken station, press **Add**.
3. Set the following:
 - **Before station**: the original station of the target point.
 - **After station**: the modified station of the target point.
4. **Optional**: To set another broken station, press **Next**, and repeat step 3.
5. Press **OK**.

5.7.1.2 Set the Centerline

It is used to define the centerline on the design to the actual road.

To set the centerline, do the following:

1. To enter **Centerline** interface, press **Centerline**:

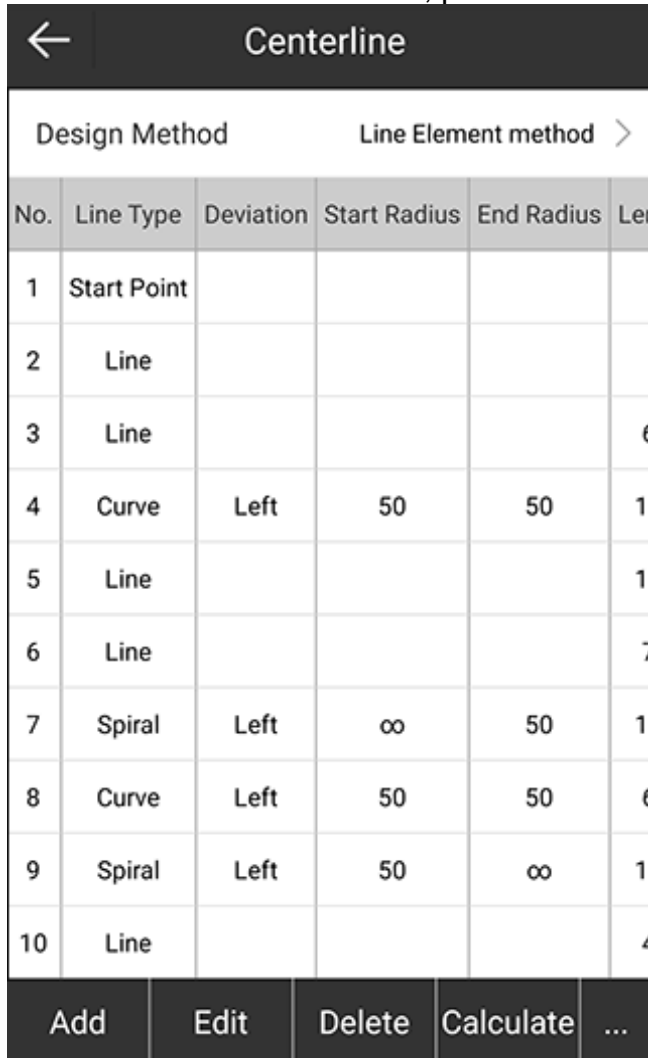

Design Method		Line Element method >			
No.	Line Type	Deviation	Start Radius	End Radius	Length
1	Start Point				
2	Line				
3	Line				6
4	Curve	Left	50	50	1
5	Line				1
6	Line				7
7	Spiral	Left	∞	50	1
8	Curve	Left	50	50	6
9	Spiral	Left	50	∞	1
10	Line				4

2. Select a design method:
 - Line element method**
 - Intersection method**
 - Coordinate element method**

3. To add a centerline, press **Add**. Taking the design method **Line element method** as an example, the interface is as follows:

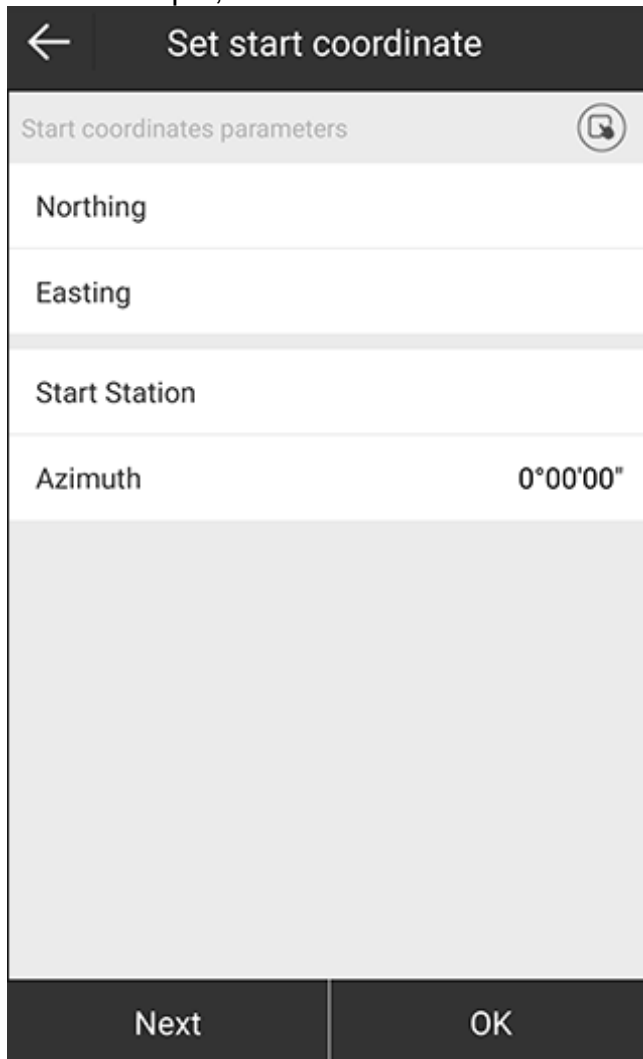

4. To set a start coordinate, do one of the following:
- To manually input coordinates, set values of **Northing** and **Easting**.
 - To select a point from the point database, press  and select the target point.
5. Set the start station and azimuth.
6. To set end point, press **Next**, or press **OK** → **Add**, and do the following:
- a. Select a line type:
 - **Line**
 - **Curve**
 - **Spiral**
 - b. Set element parameters.
 - c. Press **OK**.

7. To get coordinates of all set points, press **Calculate**. **Coordinates List** interface shows:

← Coordinates List				
Name	Station	Northing	Easting	Elevation
SP	0.000	3441262.113	359761.687	0
TT1	5.000	3441262.462	359766.675	0
20.00	20.000	3441273.952	359776.317	0
40.00	40.000	3441289.273	359789.172	0
60.00	60.000	3441304.594	359802.028	0
TC1	72.000	3441313.787	359809.742	0
80.00	80.000	3441320.3	359814.373	0
100.00	100.000	3441339.041	359820.963	0
120.00	120.000	3441358.87	359819.735	0
140.00	140.000	3441376.656	359810.882	0
CM1	150.500	3441384.203	359803.609	0
160.00	160.000	3441389.59	359795.801	0

8. To return to **Road Design** interface, press ← twice in the upper left corner.

5.7.1.3 Set the Vertical Profile

To set the vertical profile, do the following:

1. To enter **Vertical Profile Database** interface, press **Vertical Profile**:

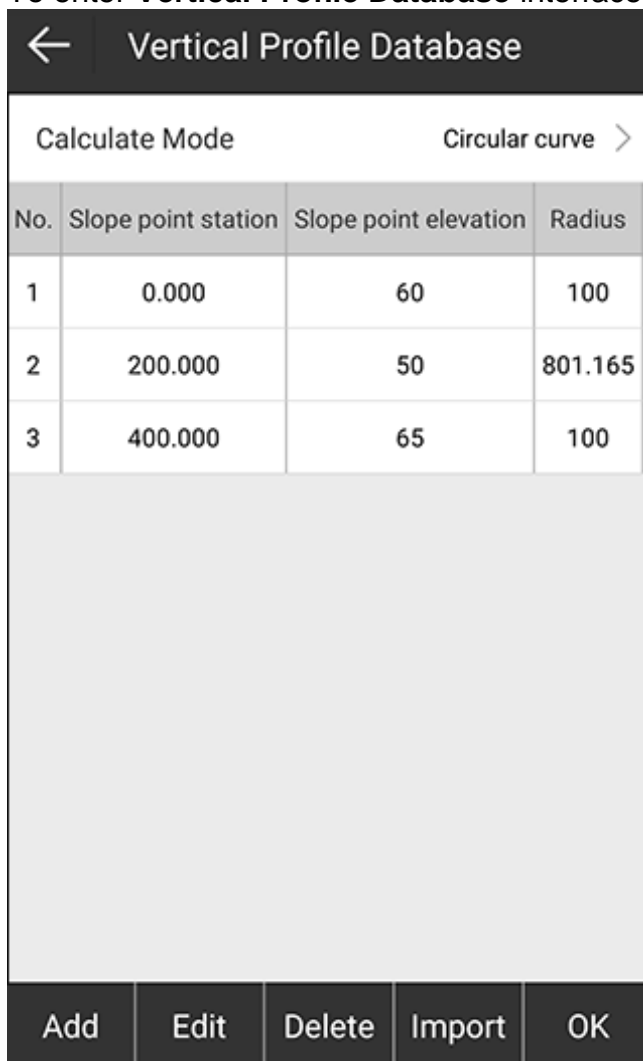

Calculate Mode		Circular curve >	
No.	Slope point station	Slope point elevation	Radius
1	0.000	60	100
2	200.000	50	801.165
3	400.000	65	100

2. Select a calculation mode:
 - Circular curve**
 - Parabola**

3. To add a vertical profile, press **Add**:

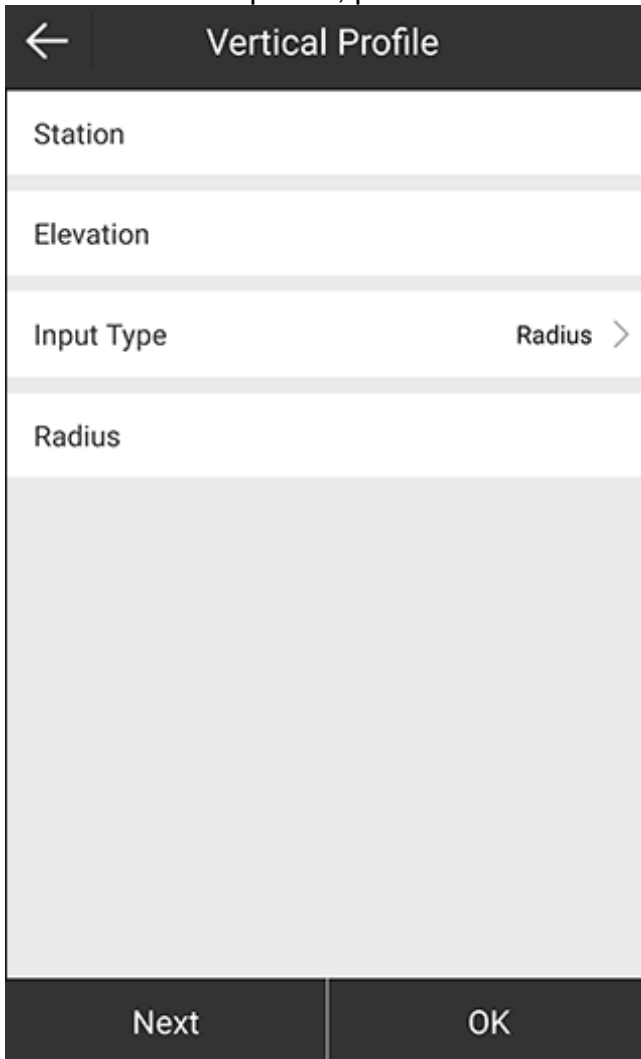

4. Set the station and elevation.
5. Select an input type (radius and spiral length), and set radius or spiral length.
6. **Optional:** To set another vertical profile, press **Next**, and repeat step 4 and 5.
7. Press **OK**.

5.7.1.4 *Set the Standard Cross Section*

To set the standard cross section, do the following:

1. To enter **Standard Cross Section** interface, press **Standard Cross Section**:

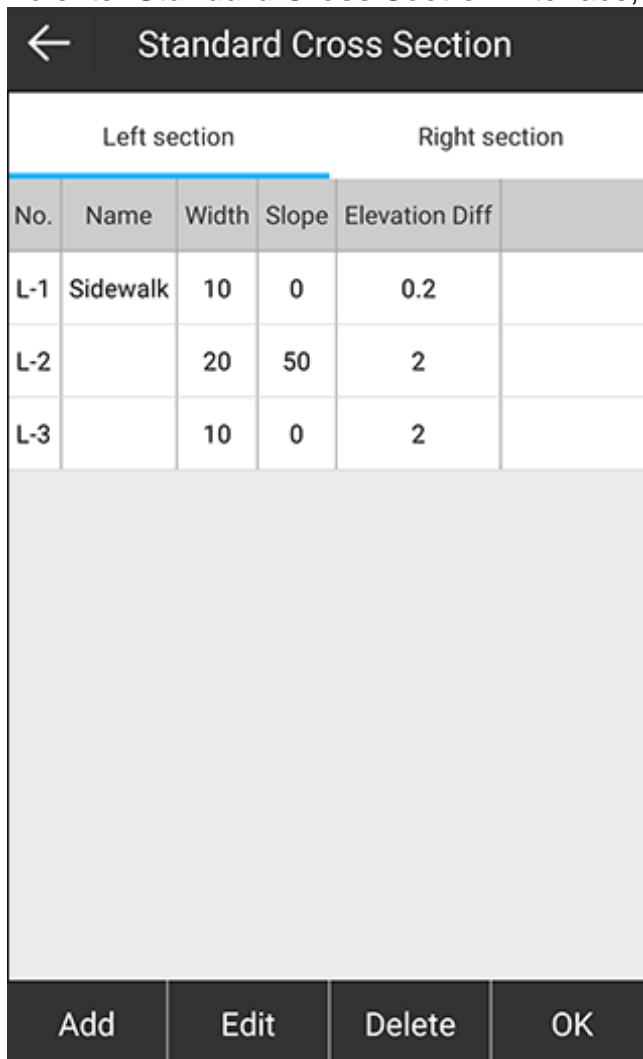

2. Select setting left section or right section.

3. To add a left or right section, press **Add**.

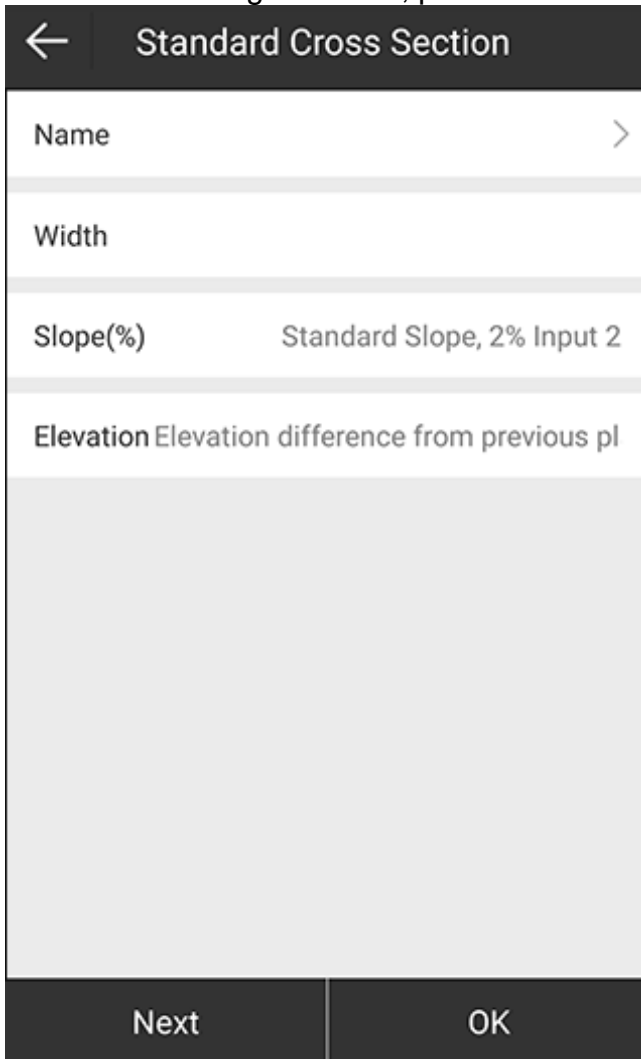

4. Set a name.
5. Set the following:
- **Width**: the horizontal length.
 - **Slope (%)**: the ratio of vertical length to horizontal length.
 - **Elevation**: the distance between the road and curb.
6. **Optional**: To set copy setting to right-section / left-section, switch to related page, and press **Symmetry**.
7. Press **OK**.

5.7.1.5 Set the Ultra Height

It is used to change the slope of the cross section.

To set the ultra height, do the following:

1. To enter **Ultra Height** interface, press **Ultra Height**:

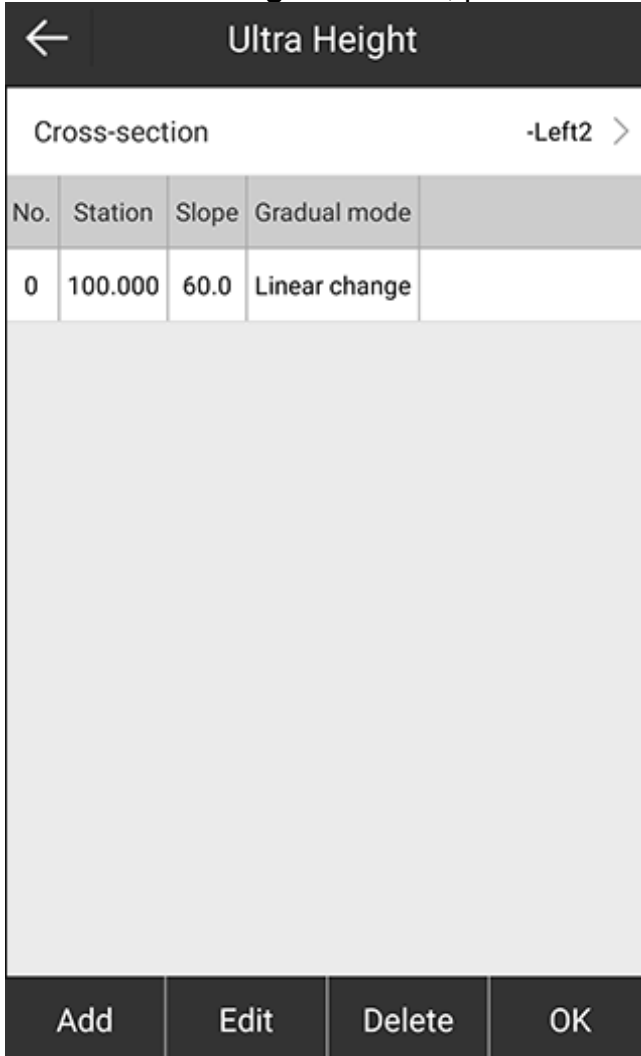

No.	Station	Slope	Gradual mode
0	100.000	60.0	Linear change

2. Select the cross-section.

3. Press **Add**. The following interface shows:

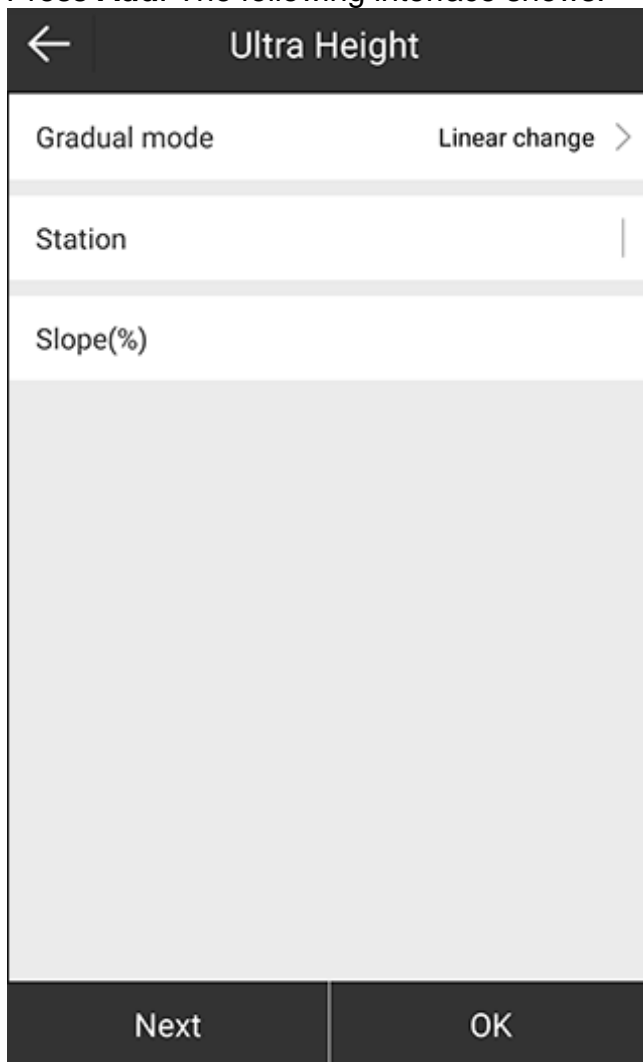

← Ultra Height

Gradual mode Linear change >

Station |

Slope(%)

Next OK

4. Select a gradual mode:
- **Linear change:**
 - **Three parabola:**
5. Set the station and slope.
6. **Optional:** To set another ultra height, press **Next**, and repeat step 4 and 5.
7. Press **OK**.

5.7.1.6 Set the Ultra Width

It is used to change the length of the cross section.

To set the ultra width, do the following:

1. To enter **Ultra Width** interface, press **Ultra Width**:

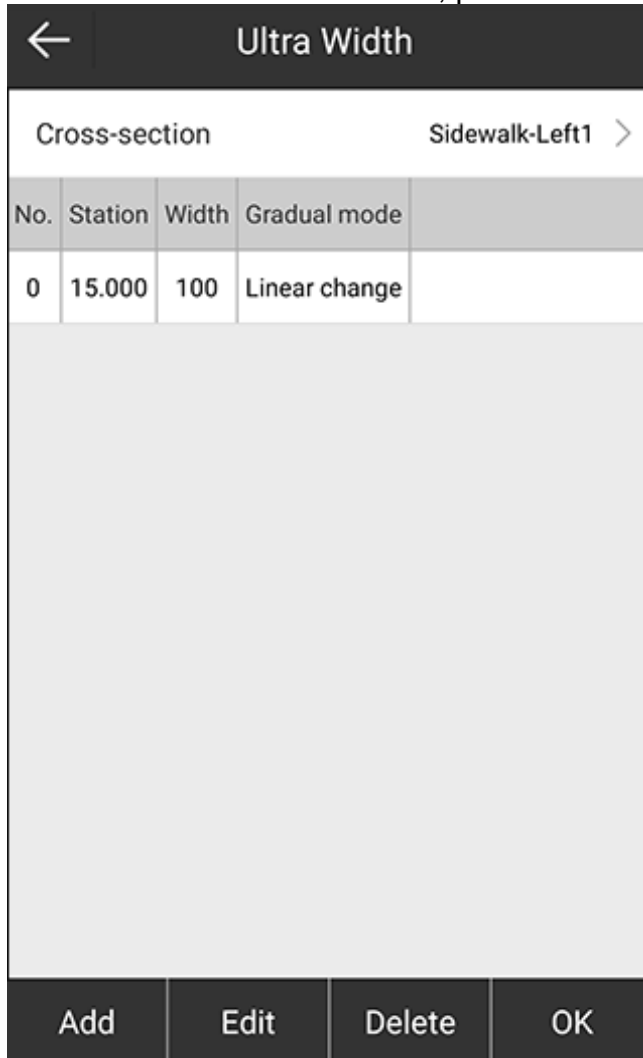

2. Select the cross-section.

3. Press **Add**. The following interface shows:

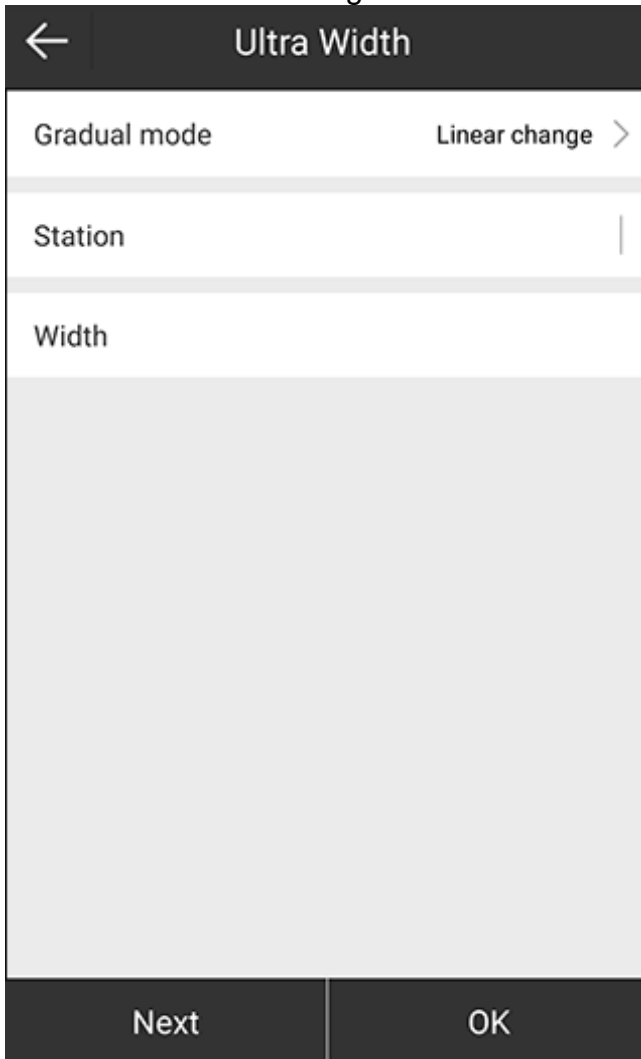

4. Select a gradual mode:
- Linear change:**
 - Three parabola:**
 - Four parabola:**
5. Set the station and width.
6. **Optional:** To set another ultra width, press **Next**, and repeat step 4 and 5.
7. Press **OK**.

5.7.1.7 Set the Slope

To set the slope, do the following:

1. To enter **Slope** interface, press **Slope**:

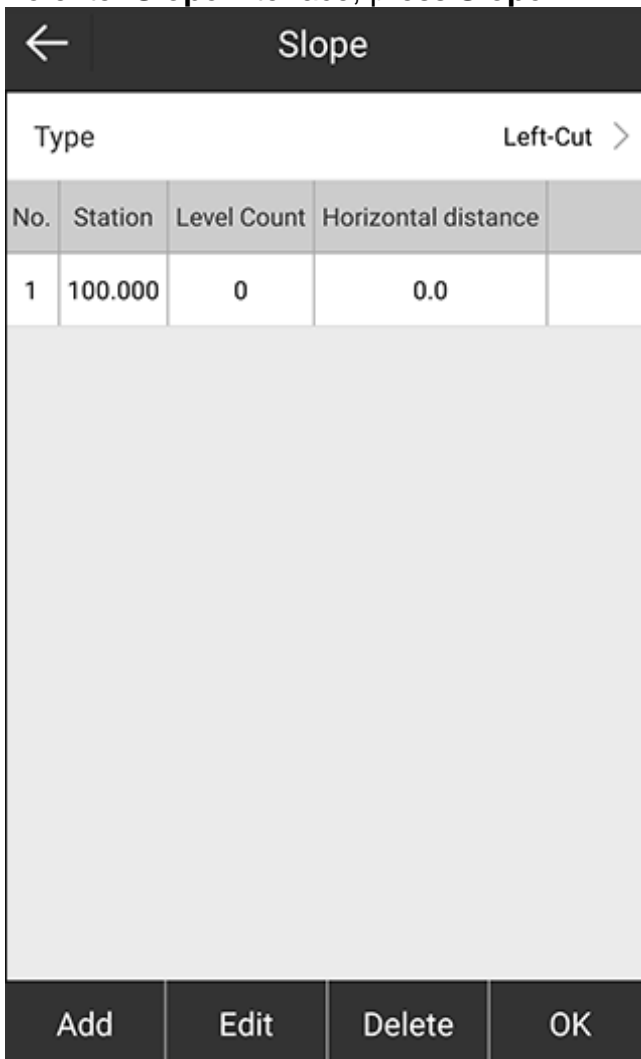

Type				Left-Cut >
No.	Station	Level Count	Horizontal distance	
1	100.000	0	0.0	

2. Select a slope type:
 - Left-cut
 - Left-fill
 - Right-cut
 - Right-fill

3. Press **Add**. **Add Slope** interface shows:



The screenshot shows a mobile application interface titled "Add Slope". At the top left is a back arrow icon. Below the title is a text input field labeled "Station". The main content is a table with the following data:

No.	Type	Height/Width	Ratio/Slope	Width	
1	Slope	10	1:10	100	
2	Platform	19	5%	19	

Below the table is a large grey rectangular area. At the bottom of the screen is a dark navigation bar with four buttons: "Add", "Edit", "Delete", and "OK".

4. Set the station, and press **Add**:

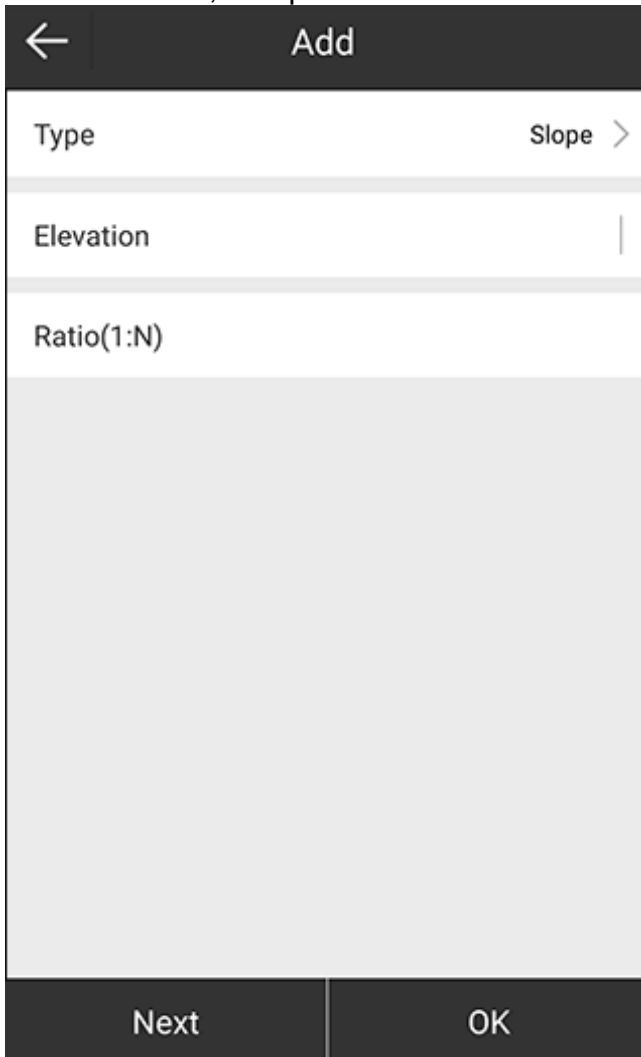

5. Select a type (slope or platform).
6. Set elevation and ratio(1:N).
7. **Optional:** To set another slope, press **Next**, and set related items. The interface returns to **Add Slope** interface.
8. Select the target type, and press **OK**. The interface returns to **Slope** interface.
9. Select the target slope, and press **OK**.

5.7.2 Manage Road Stakeout Database

To manage road stakeout database, do the following:

1. To enter **Stake Road** interface, do one of the following:
 - If it is your first time to start road stakeout, press main menu **Survey** → **Stake Road**.



- In the main interface of road stakeout, press





2. Do the following:
 - Add a new road stakeout.
 - Edit a road stakeout.
 - Delete a road stakeout.
 - Import a road stakeout.

5.7.3 Switch the Road Stakeout Mode

Road stakeout mode includes the following:

- Centerline stakeout
- Cross-station stakeout: it is to stake out the designed road on the drawing to the corresponding ground by marking the excavation line and filling line for construction.

To switch the road stakeout mode, do one of the following in the main interface of road stakeout:

- To switch to centerline stakeout, press .
- To switch to cross-station stakeout, press .

5.7.4 Set Display Information

It is used to customize display information, including stakeout settings, topo point, information bar, and toolbars.

To set display information, do the following:

1. In the main interface of road stakeout, press . **Display Information** interface shows:

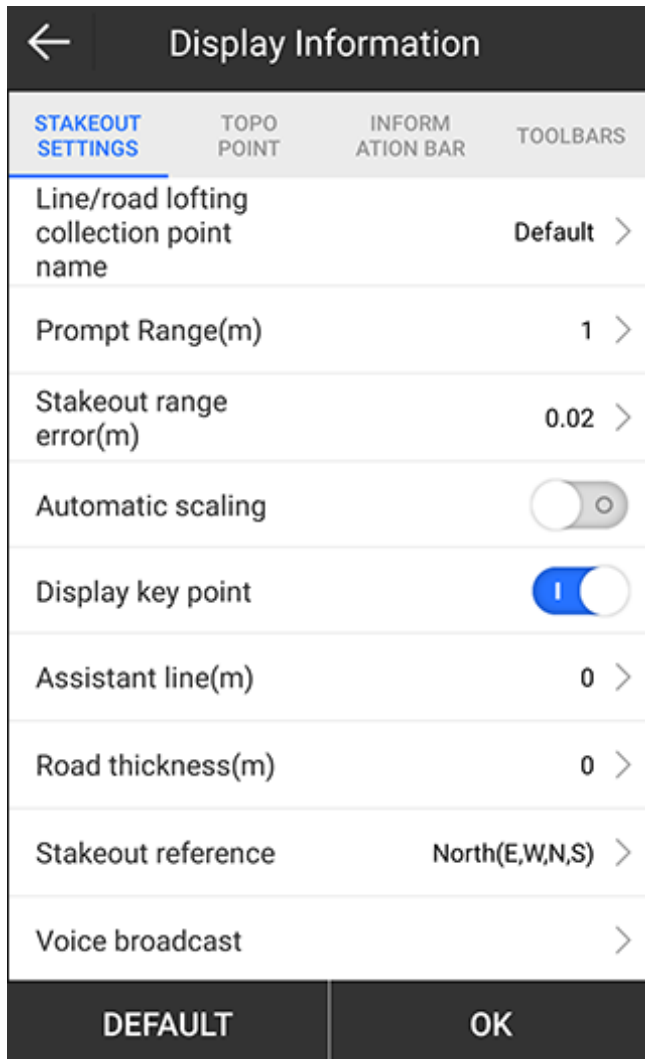

2. Set stakeout settings, topo point, information bar and toolbars. See [5.4.2 Set Display Information in point stakeout](#) for details.

5.7.5 Start Road Stakeout

To start road stakeout, do the following:

1. According to the engineering design, edit the stakeout road in road stakeout database.
2. Select the target stakeout road and press **OK** to enter the main interface of road stakeout.

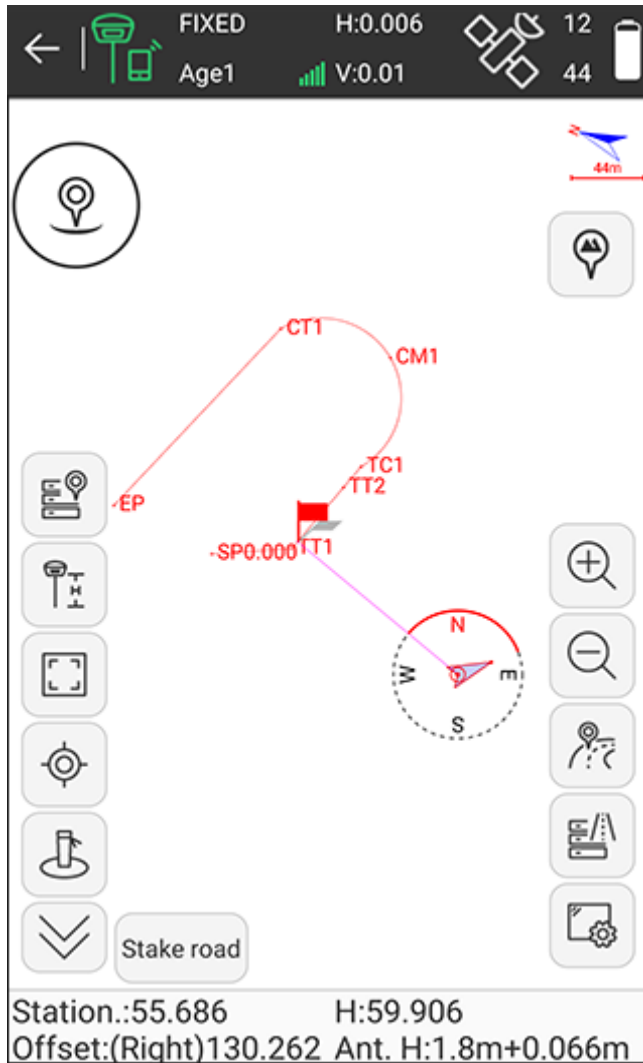

3. **Optional:** To view slope graph in the range of the current station based on the

calculated station, press  :

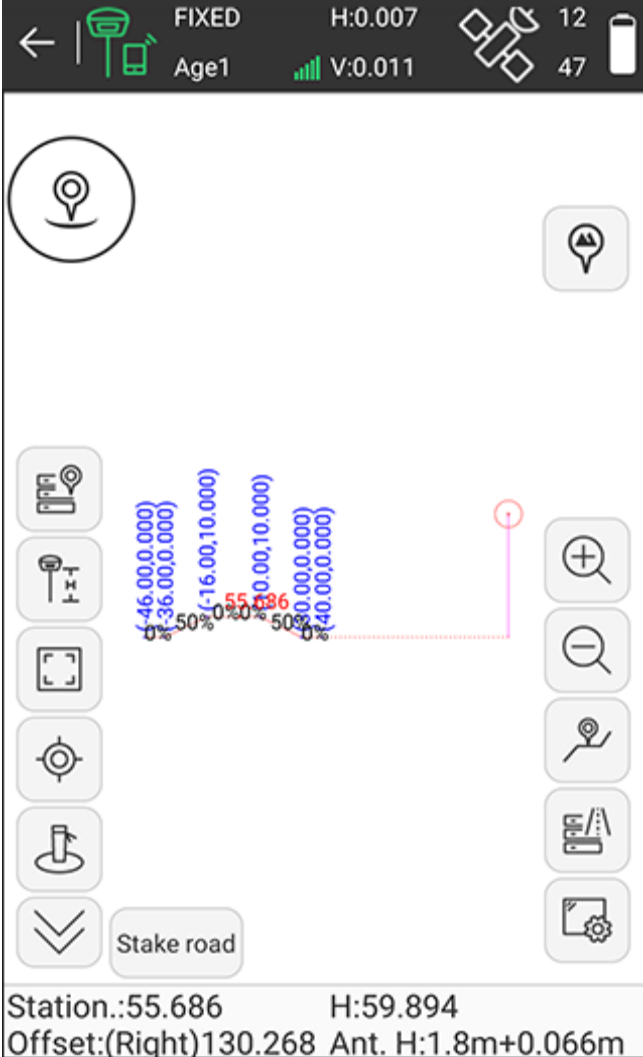

Station.:55.686 H:59.894
Offset:(Right)130.268 Ant. H:1.8m+0.066m

4. Move towards the indicated direction according to information in the information bar.

5. After reaching the stakeout road, stake it.

5.8 Stake Road by Point

It is used for continuous stakeout of specific stakes with fixed stake distance like 20 / 50 / 100 or with specific stake number as construction required.

To enter the main interface of road stakeout by point, press **Survey** → **Stake Road by Point**, add a new road stakeout / select a road stakeout, press **OK**, set stakeout settings, and press **OK**:

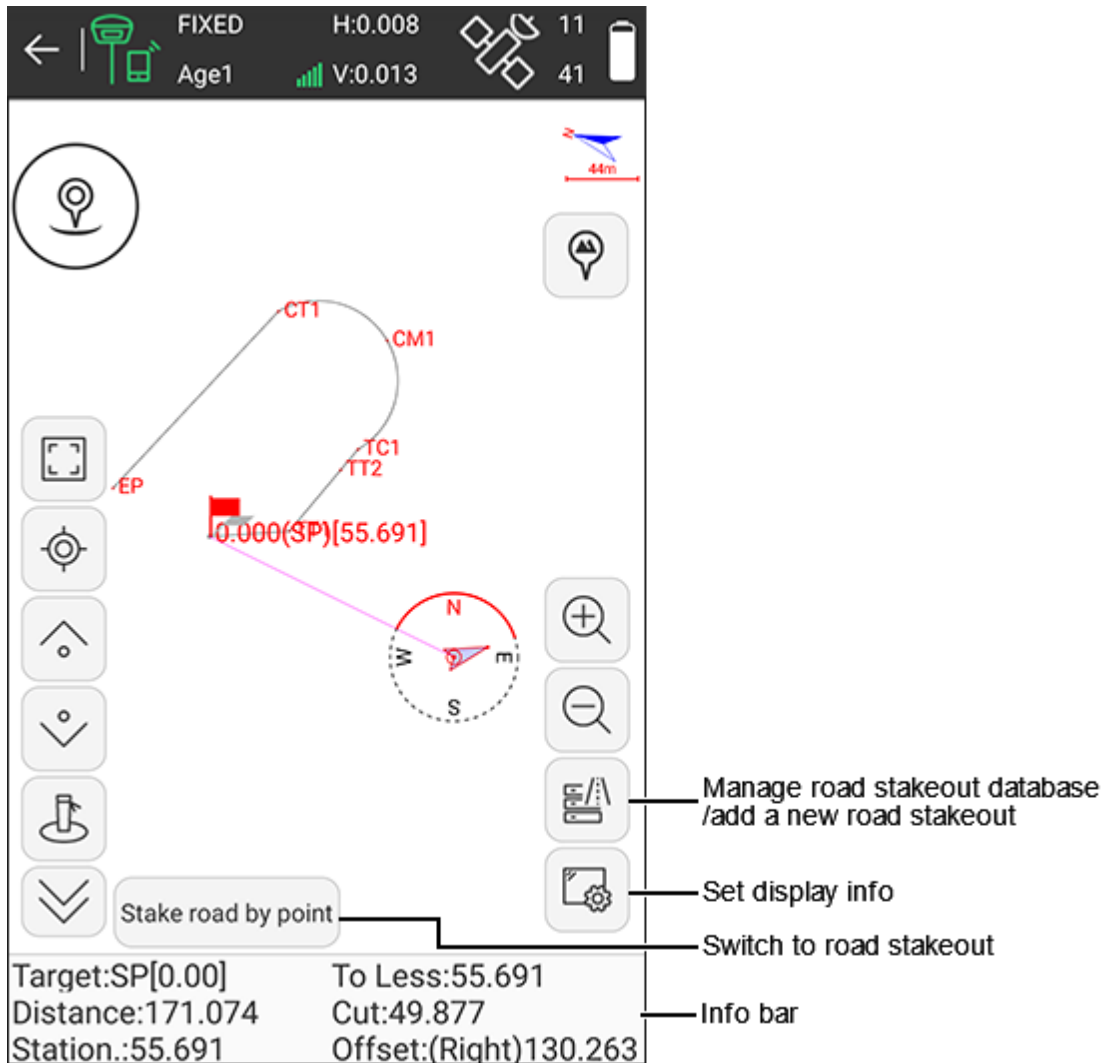

Information bar

- **Target:** the name of the stakeout road.
- **To More / To Less:** the distance from the current point to target peg. **To More** means the station of the target point is greater than the station of the current point. **To Less** means the station of the target point is less than the station of the current point.
- **Distance:** the distance between the receiver and the stakeout point.
- **Cut / Fill:** if **Cut** shows, the current position is higher than target point; if **Fill** shows, the current position is lower than target positions.
- **Station:** making a perpendicular to the stakeout line through the current receiver position, the start station plus the distance between the foot of perpendicular and the start point.

- **Offset:** the perpendicular distance from the current position to the target line.

5.8.1 Set Stakeout Settings

To set stakeout settings, do the following:

1. To enter **Stakeout Settings** interface, press **Survey** → **Stake Road by Point**, add a new road stakeout / select a road stakeout, press **OK**:

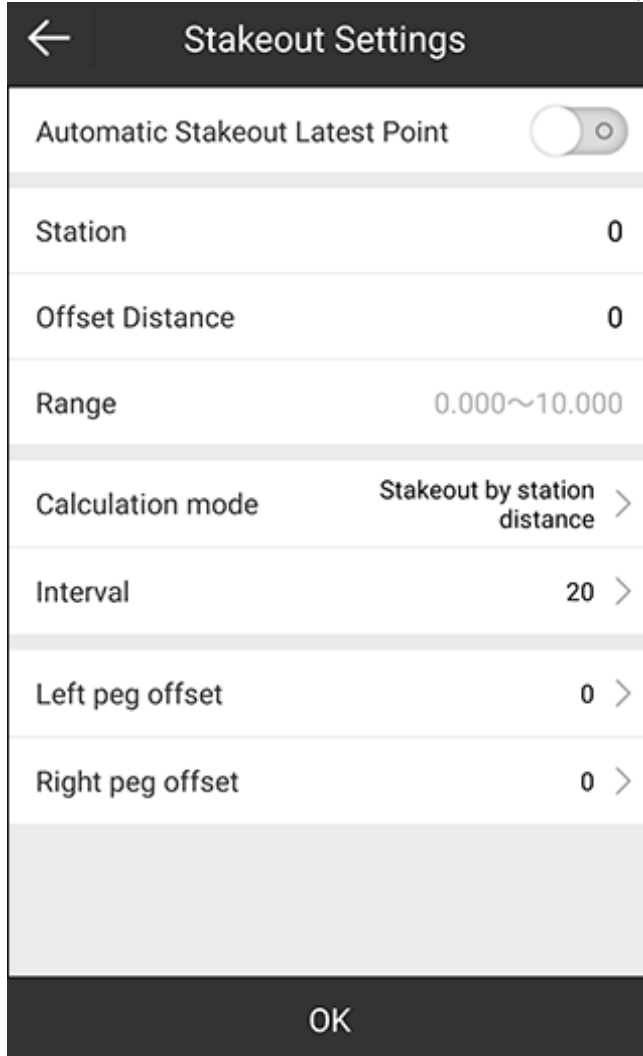

2. Select whether to automatically stake out the latest point.
3. Set station, offset distance and range.
4. Select a calculation mode:
 - **Stakeout by station number**
 - **Stakeout by station distance**
5. Set interval.
6. Set left peg offset and right peg offset.
7. Press **OK**.

5.8.2 Add a New Road Stakeout

To add a new stakeout road, see [5.7.1 Add a New Road Stakeout](#) for details.

5.8.3 Manage Road Stakeout Database

To manage road stakeout database, see [5.7.2 Manage Road Stakeout Database](#) for details.

5.8.4 Set Display Information

To set display information, see [5.4.2 Set Display Information](#) in point stakeout for details.

5.8.5 Start Road Stakeout by Point

To start road stakeout by point, do the following:

1. Select the target stakeout road and press **OK**.
2. Set stakeout settings, and press **OK** to enter the main interface of road stakeout by point.
See [5.8.1 Set Stakeout Settings](#) for details.
3. Move towards the indicated direction according to information in the information bar.
4. After reaching the stakeout point of the road, stake it.

5.9 Cross Section Measurement

Cutting a road into slices creates many parallel cross sections. This operation is used to mark the position of cross sections for line engineering and hydraulic engineering.

To enter the main interface of cross section measurement, press **Survey** → **Cross Section Measurement**, add a new road stakeout / select a road stakeout, press **OK**, set stakeout settings, and press **OK**:

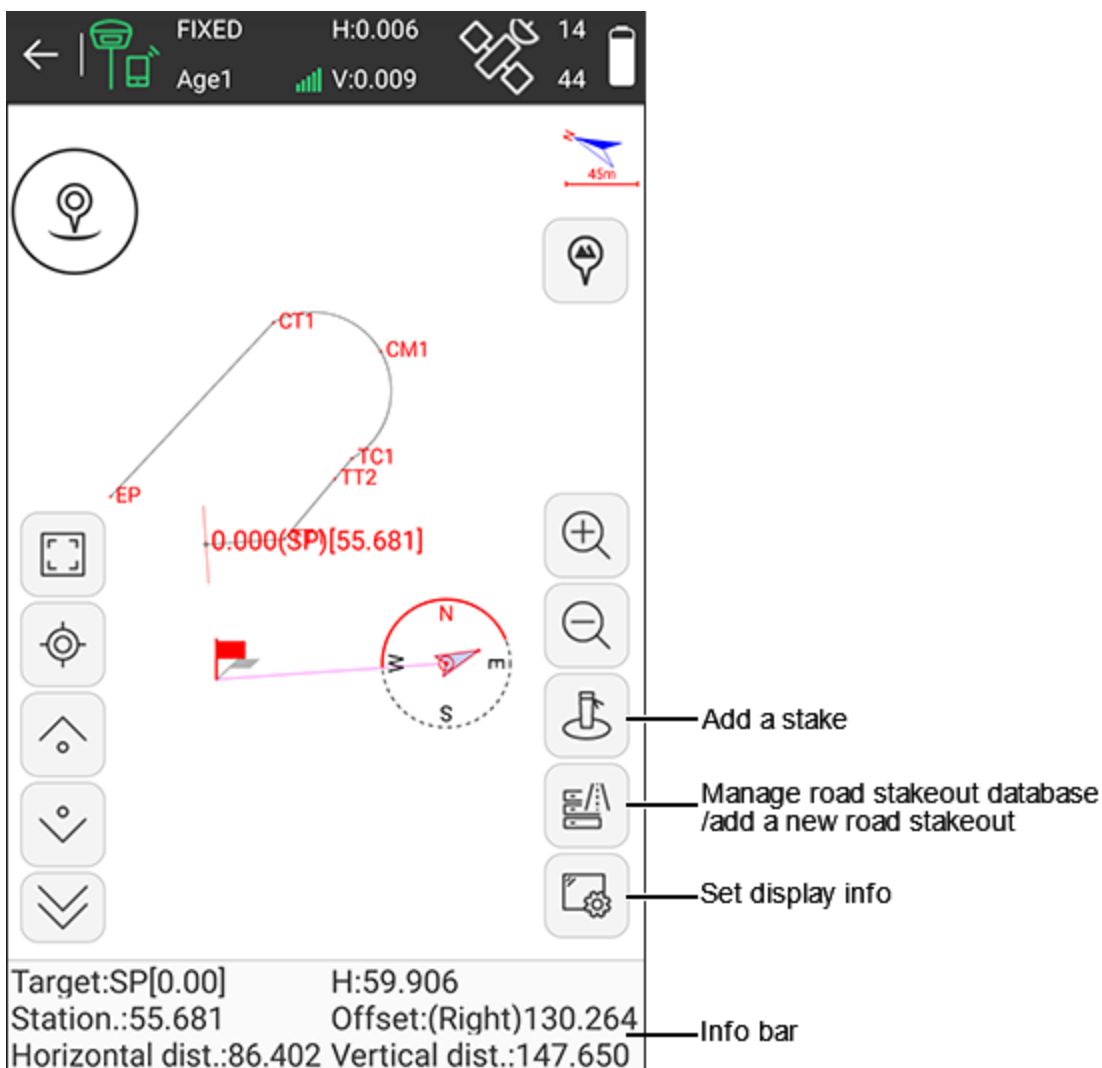

Information bar

- **Target:** the name of the current stakeout road.
- **H:** the elevation of the current receiver position.
- **Station:** making a perpendicular to the stakeout line through the current receiver position, the start station plus the distance between the foot of perpendicular and the start point.
- **Offset:** the perpendicular distance from the current position to the target line.
- **Horizontal dist.:** making a perpendicular to the cross section through the current receiver position, the distance from the foot of perpendicular to the intersection point of the cross section and stakeout line.
- **Vertical dist.:** making a perpendicular to the cross section through the current receiver position, the distance from the foot of perpendicular to the current position of the receiver.

5.9.1 Set Stakeout Settings

To set stakeout settings, do the following:

1. To enter **Stakeout Settings** interface, press **Survey** → **Cross Section Measurement**, add a new road stakeout / select a road stakeout, press **OK**:

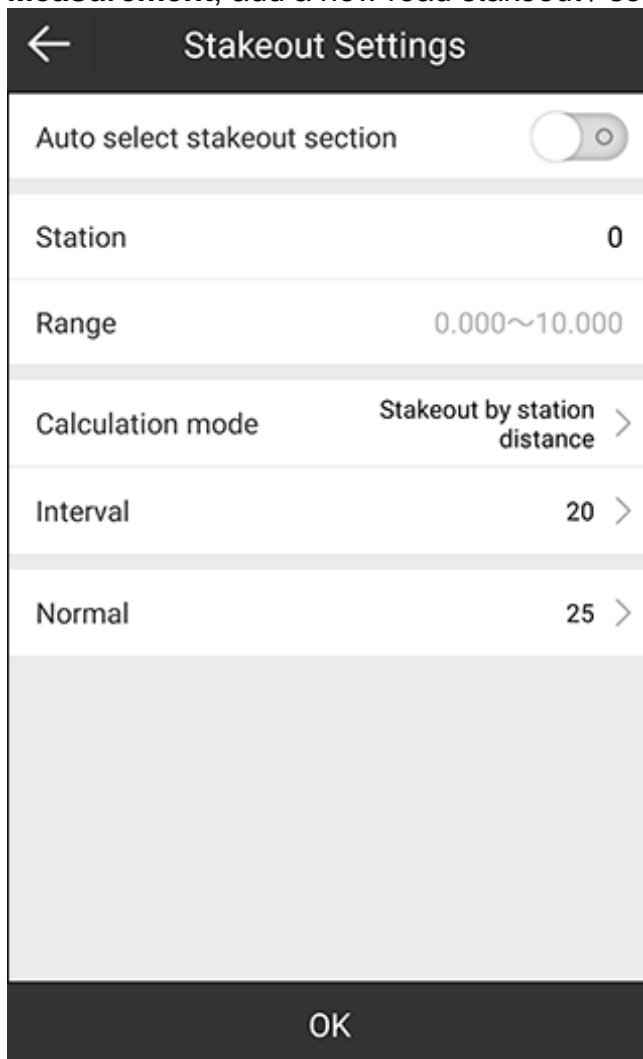

2. Select whether to automatically stake out the latest point.
3. Set station.

4. Select a calculation mode:
 - **Stakeout by station number**
 - **Stakeout by station distance**
5. Set interval.
6. Set the length of normal (the distance between the centerline and the ends of cross section).
7. Press **OK**.

5.9.2 Add a New Stakeout Road

To add a new stakeout road, see [5.7.1 Add a New Road Stakeout](#) for details.

5.9.3 Manage Road Stakeout Database

To manage road stakeout database, see [5.7.2 Manage Road Stakeout Database](#) for details.

5.9.4 Set Display Information

To set display information, see [5.4.2 Set Display Information](#) in point stakeout for details.

5.9.5 Start Cross Section Measurement

To start cross section measurement, do the following:

1. According to the engineering design, edit the stakeout road in road stakeout database.
2. Select the target stakeout road and press **OK**.
3. Set stakeout settings, and press **OK** to enter the main interface of cross section stakeout.
See [5.9.1 Set Stakeout Settings](#) for details.
4. Move towards the indicated direction according to information in the information bar.
5. **Optional:** To add a stake to the cross section during stakeout process, see [5.5.4 Add a Stake in line stakeout](#) for details.
6. After reaching the stakeout road, stake it.

5.10 Layers Settings

The main interface is as follows:

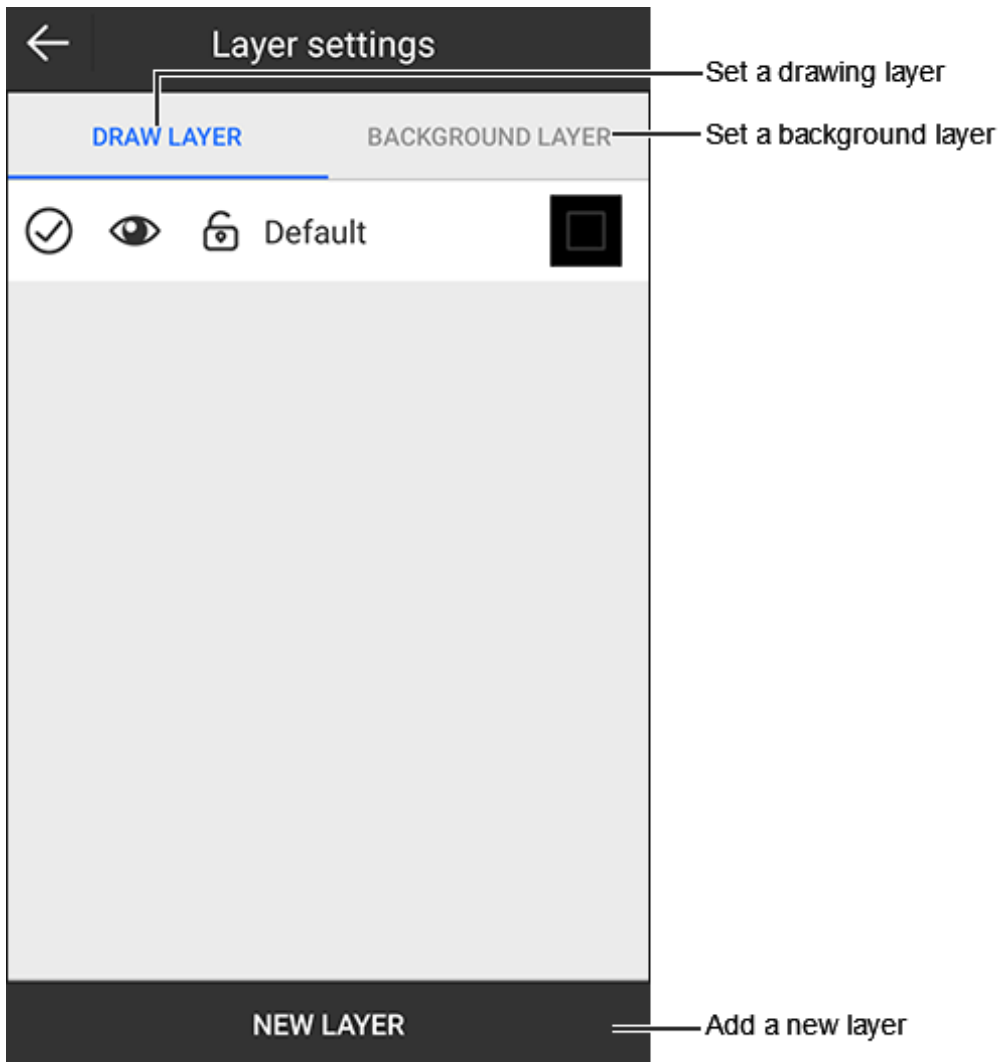

5.10.1 Set Drawing Layer

See [5.3.1](#) Manage the Layer for details.

5.10.2 Set Background Layer

To set background layer, do the following:

1. Switch to **BACKGROUND LAYER** page:

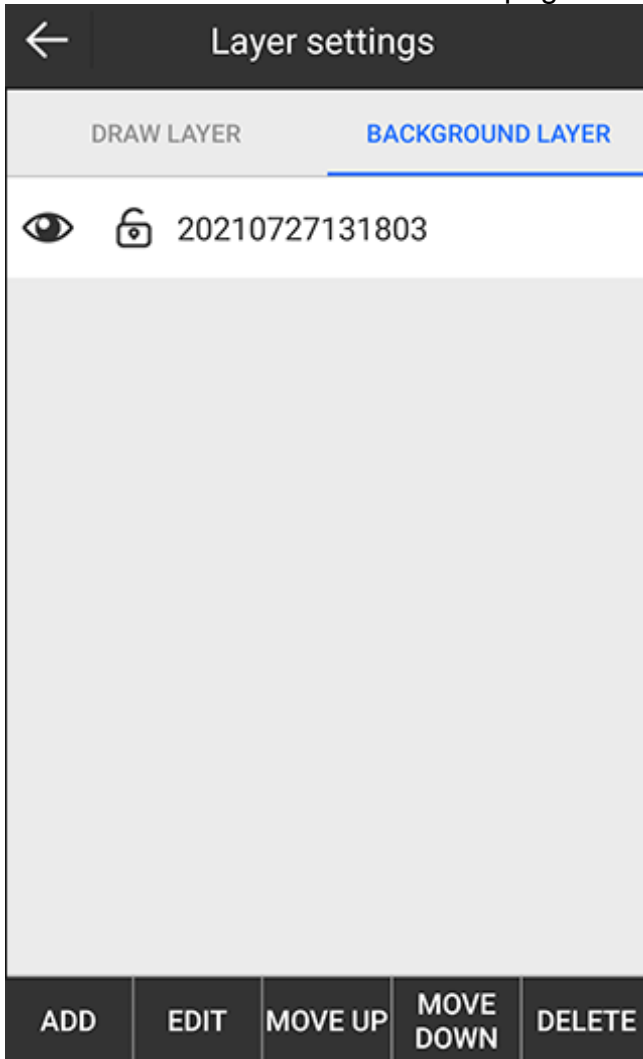

- Press **ADD**, and select the target format and file. **Layer Properties** interface shows:

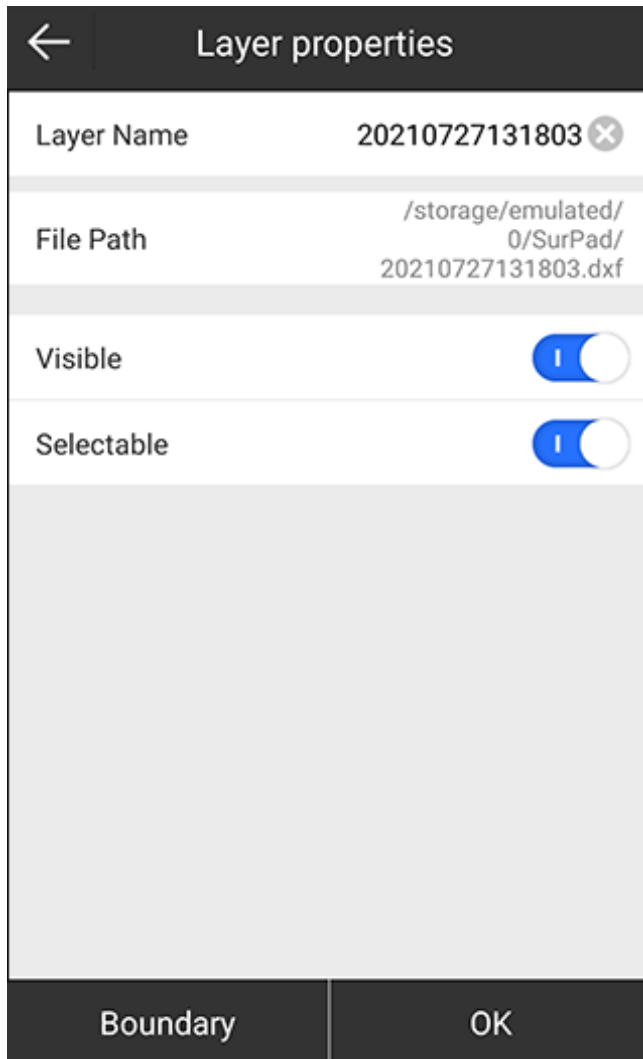

Supported file format:

- AutoCAD file: *.dxf, *.dwg
 - Shape file: *.shp
 - LandXML: *.xml
- Edit properties of the target layer.
 - Optional:** To check the layer boundary, press **Boundary**.
 - Do the following in **BACKGROUND LAYER** page based on your needs:
 - To edit the target layer, select the target layer, and press **EDIT**.
 - To move the target layer down, select the target layer, and press **MOVE UP**.
 - To move the target layer up, select the target layer, and press **MOVE DOWN**.
 - To delete the target layer, select the target layer, and press **DELETE**.

5.11 Survey Range Settings

It is used to set the survey range and make sure all measured points are within the range. When the current point exceeds the range, a prompt shows.

Press main menu **Survey** → **Survey Range Settings**. **Survey Range Settings** interface shows:

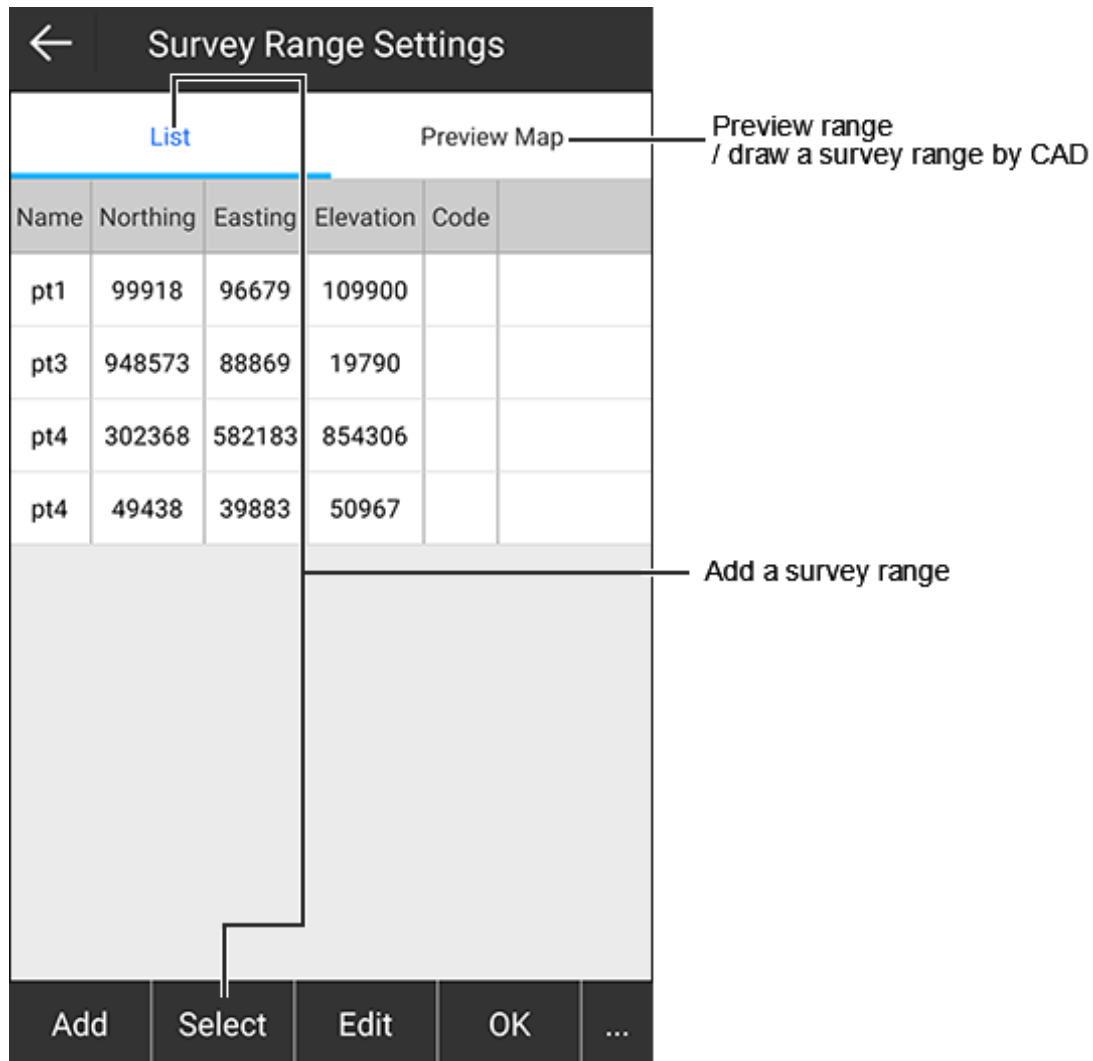

After adding or drawing a survey range, to check if the current point exceeds the set range, enter the main interface of point survey:

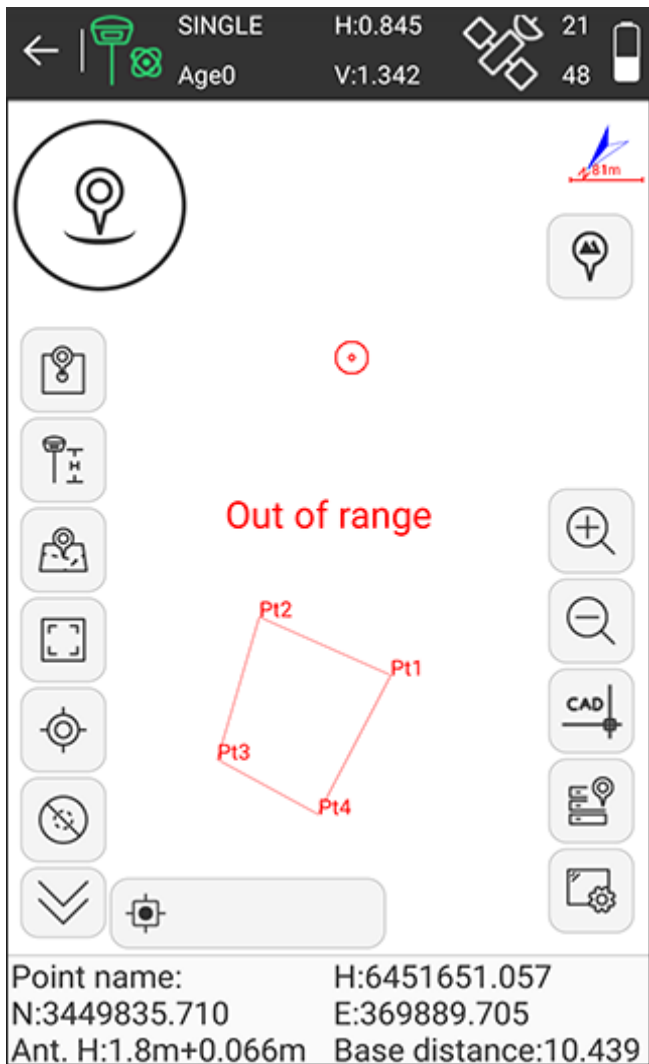



5.11.1 Add a Survey Range

To add a survey range, do the following:

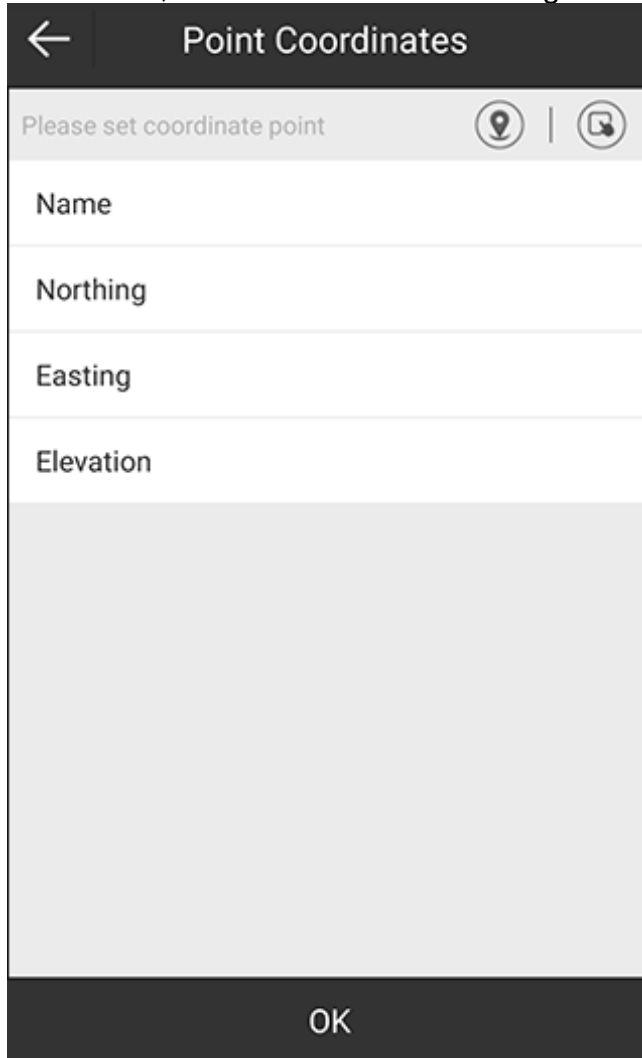
1. In **List** page, do one of the following:
 - Press **Add**, and do one of the following to set coordinates of a point:



- To use the current GPS coordinates, press  and set antenna parameters.
- To select a point from the point database, press  and select the target point.
- To manually input coordinates, set values of **Northing**, **Easting** and **Elevation**.
- To select points in batch mode, press **Select**, and select the target points.

2. Press **OK**.

Alternatively, you can press **Select** in **List** page, and select points from the point database.

5.11.2 Draw a Survey Range by CAD

To draw a survey range by CAD, do the following:

1. In **Preview Map** page, press **CAD**:

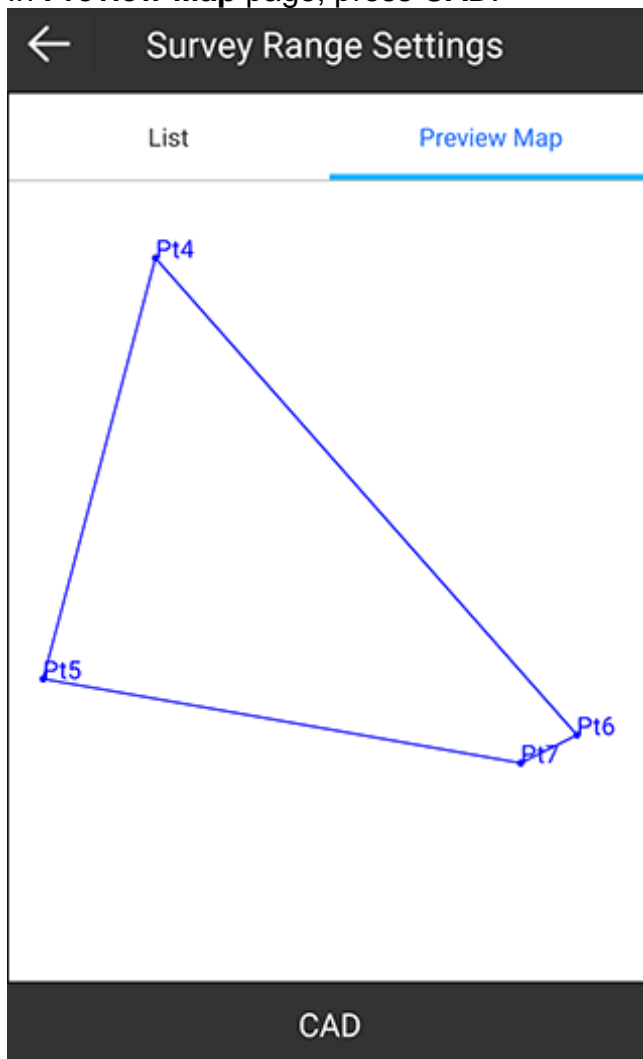

2. Do one of the following:
 - Select to load the last CAD drawing.
 - Draw a range by CAD drawing tools.
3. Select the drawing, and press **OK** to exit CAD. The interface returns to **Preview Map** page.



CAUTION: Selecting the drawing is required. Otherwise, drawing a survey range by CAD will fail.

4. Switch to **List** page, press **OK**.

6 Tools

6.1 Localization

In general, the output data of the receiver is WGS-84 latitude and longitude coordinates. The coordinates need to be converted to local coordinates, which requires SurPad to calculate and configure coordinate conversion parameters. Localization is the main tool to achieve this.

Press main menu **Tools** → **Localization** to enter **Localization** interface:

The screenshot shows the 'Localization' interface with a table of points and a bottom menu. The table has columns for No., Name, Northing, Easting, H, and Latitude. The first row is highlighted in yellow. The bottom menu includes 'Add', 'Edit', 'Delete', 'Calculate', and '...'.

No.	Name	Northing	Easting	H	Latitude
0	Pt1	0	0	0	
1	Pt2	2	2	2	
2	3	2	2	1	

Point database

- Add a new point
- Edit a point
- Delete a a point
- Get GPS parameter report
- Do the following:
 - Import points
 - Export points
 - Set localization settings

6.1.1 Add a Localization Point

To add a localization point, do the following:

1. Press **Add**. The following interface shows:

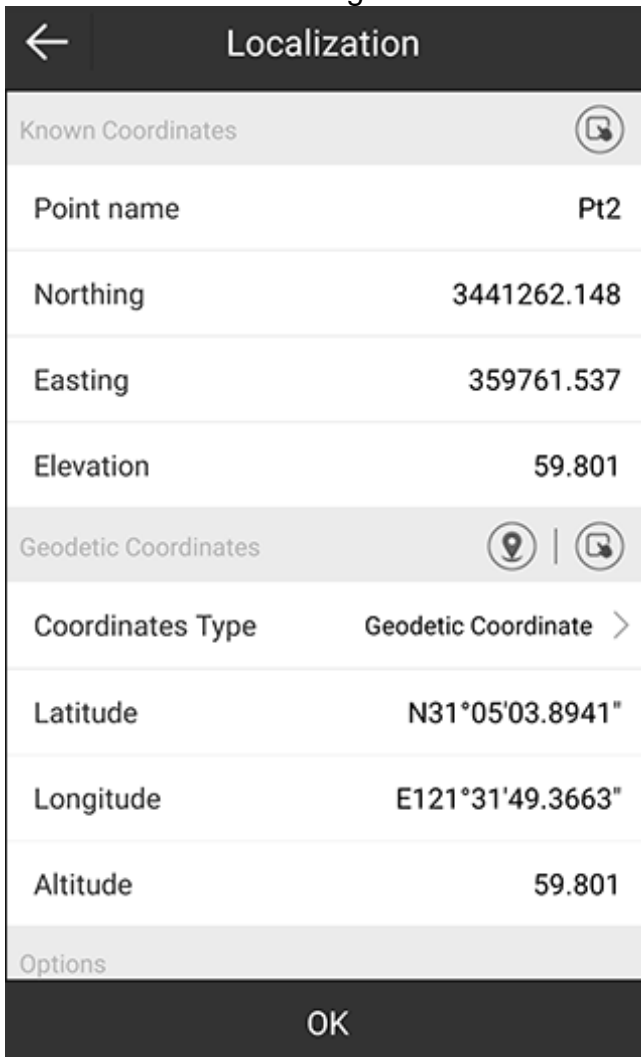

Known Coordinates	
Point name	Pt2
Northing	3441262.148
Easting	359761.537
Elevation	59.801
Geodetic Coordinates	
Coordinates Type	Geodetic Coordinate >
Latitude	N31°05'03.8941"
Longitude	E121°31'49.3663"
Altitude	59.801



Options

OK

2. To set coordinates of a known point, do one of the following in **Known Coordinates** area:

- To select a point from the point database, press  and select the target point.
- To manually input coordinates, set point name and values of **Northing**, **Easting** and **Elevation**.

3. To set WGS84 geodetic coordinates, do one of the following in **Geodetic Coordinates** area:

- To use the current GPS coordinates, press , set antenna parameters, and a point name.
- To select a point from the point database, press  and select the target point.
- To manually input the coordinates, select one of the following coordinate types and set coordinates:
 - **Geodetic coordinate**: including latitude, longitude and altitude.
 - **Local coordinate**: including northing, easting and elevation.

4. Select whether to enable the horizontal control and vertical control.

5. Press **OK**.

6.1.2 Edit a Localization Point

To edit a localization point, do the following:

1. Select the target point, and press **Edit**.
2. Edit parameters of this point.
See [6.1.1 Add a Localization Point](#) for details.

6.1.3 Delete a Localization Point

To delete a localization point, do the following:

1. Select the target point, and press **Delete**. A prompt *Are you sure to delete this record?* shows.
2. Press **OK**.

All data about this point is deleted from the point database.

6.1.4 Set Localization Settings

To set localization settings, do the following:

1. To enter **Localization Settings**, press ... → **Options**:

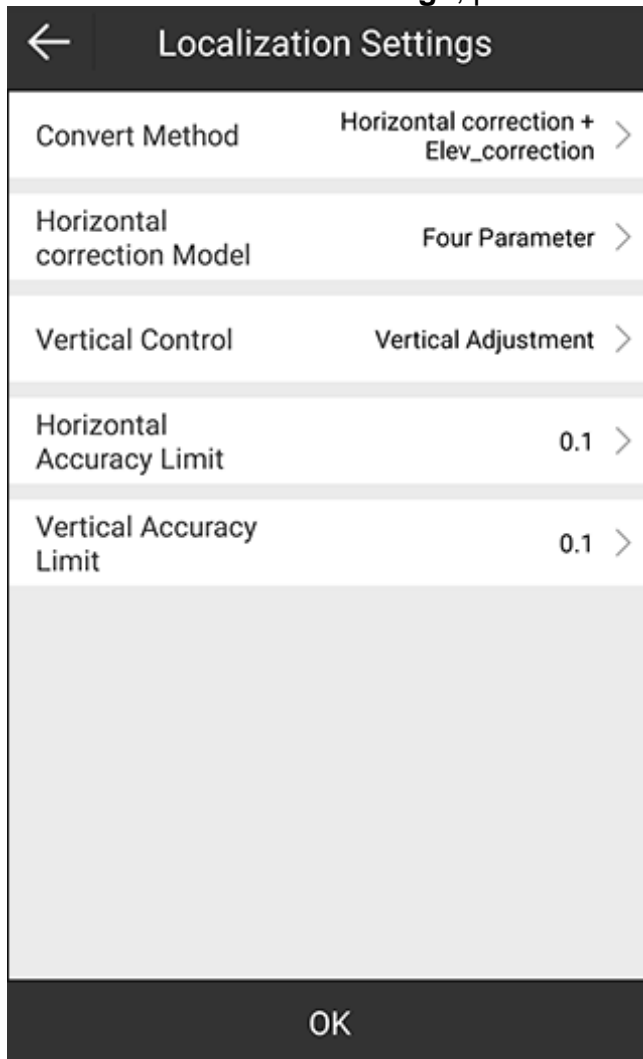

2. Select a conversion method:
 - **Horizontal correction + Elev_correction**
 - **Horizontal + Vertical Adjustment**
 - **Seven parameter + Horizontal correction + Elev_correction**
 - **Seven Parameter**
3. **Optional:** If the conversion method is set as **Horizontal correction + Elev_correction** or **Seven parameter + Horizontal correction + Elev_correction**, select a horizontal correction model:
 - **Horizontal Adjustment**
 - **Four Parameter**
4. **Optional:** If the conversion method is set as **Horizontal correction + Elev_correction** or **Seven parameter + Horizontal correction + Elev_correction**, select a vertical control mode:
 - **Automatic Selection**
 - **Weighted Average**
 - **Plane Fitting**
 - **Surface Fitting**

- **Vertical Adjustment**

5. Set horizontal accuracy limit and vertical accuracy limit.

If points in the coordinate point database exceed the set horizontal accuracy limit, information about these points turns red:

← Localization					
No.	Name	Northing	Easting	H	Latitude
0	Pt1	0	0	0	
1	Pt2	2	2	2	
2	3	2	2	1	

Add	Edit	Delete	Calculate	...
-----	------	--------	-----------	-----

6.1.5 Get the GPS Parameter Report

After all points participated in the parameter calculation have been add, you can get the GPS parameter report.

To get the GPS parameter report, do the following:

1. Press **Calculate. GPS Parameters Report** interface shows:

GPS Parameters Report	
Ellipsoid Parameter	
Ellipsoid Name	WGS 84
Semimajor axis	6378137
1/f	298.257
Projections Parameter	
Projections Mode	UTM
Central Meridian	E123°00'00"
Northing constant	0
Easting constant	500000
Scale Factor	0.9996
Projection Height	0
Latitude of Origin	N0°00'00"
Save	Apply

2. **Optional:** To export the report, press **Save** and select the target storage path.
3. To refresh data in the coordinate point database, press **Apply**.

To check whether the calculation results are accurate or reliable, find known points to check the coordinate accuracy. See [5.1](#) Point Survey for details.

6.1.6 Import Localization Points

It is used to import localization points in *.cot, *.loc, *.fou, *.tfou. formats.

To import a localization point, do the following:

1. Press ... → **Import**.
2. Select the target storage path, and press **OK**.

6.1.7 Export Localization Points

It is used to export localization points in *.cot format for later use.

To export a localization point, do the following:

1. Press ... → **Export**.
2. Select the target storage path, and press **Export**.

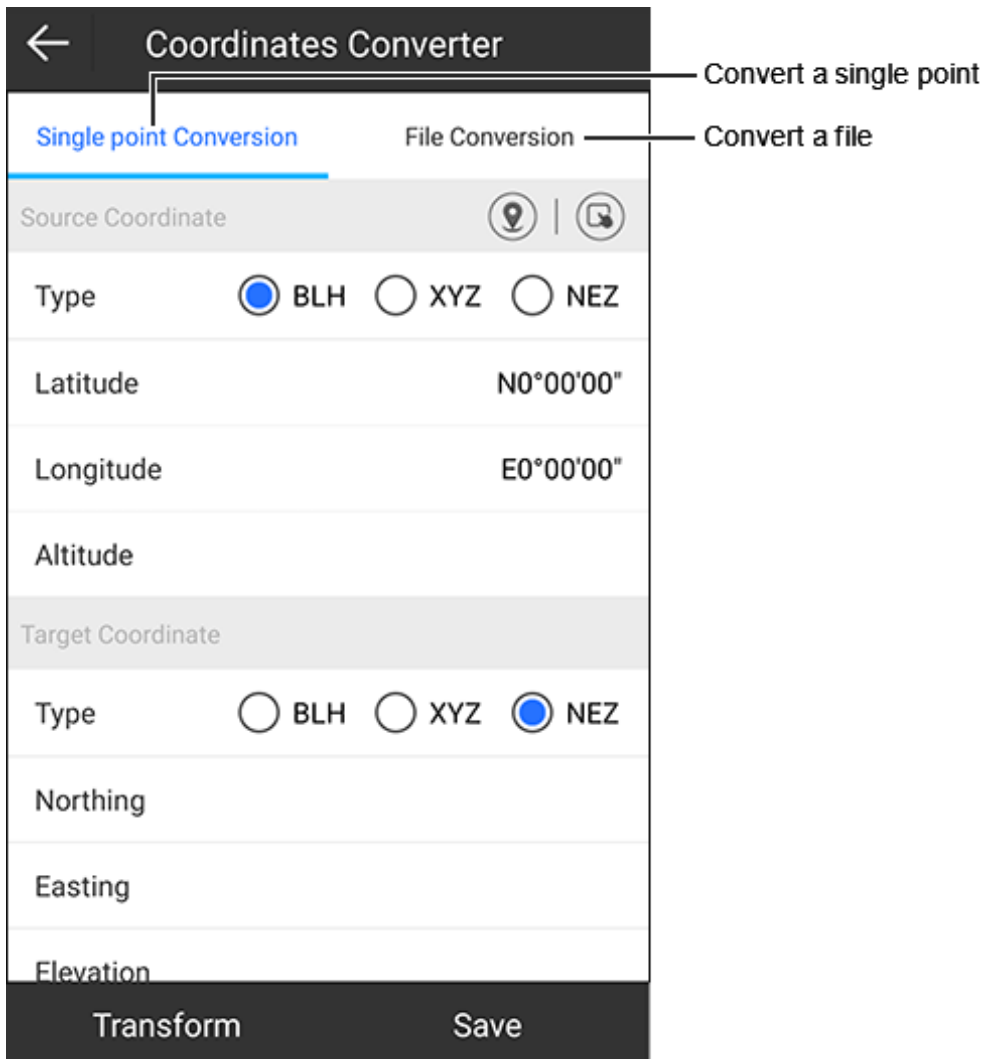

6.2 Coordinates Converter

Press main menu **Tools** → **Coordinates Converter** to enter **Coordinates Converter**:



6.2.1 Convert a Single Point

To convert a single point, do the following:

1. Select a type of the source coordinate:
 - **BLH**: including latitude, longitude and altitude.
 - **XYZ**: the geocentric coordinate, including X, Y, and Z.
 - **NEZ**: including northing, easting and elevation.
2. To set the source coordinate, do one of the following:
 - To use the current GPS coordinates, press , set antenna parameters and a point name.
 - To select a point from the point database, press  and select the target point.
 - To manually input coordinates, set values of coordinates.

3. To select a type of the target coordinate:
 - **BLH**
 - **XYZ**
 - **NEZ**
4. Press **Transform**. The result automatically shows in **Target Coordinate** area.
5. **Optional**: To save the converted coordinates as a new point to the point database, press **Save**, and input a point name.

6.2.2 Convert a File

To convert a file, do the following:

1. Select a type of the source coordinate:
 - **BLH**
 - **XYZ**
 - **NEZ**
2. To select the format for the file to import, press **File**, do one of the following, and press **OK**:
 - Set file format, angle format and select whether to preview the file.
 - Press **Format Manager** and customize a file format.
3. Select the target storage path.
4. select a type of the target coordinate:
 - **BLH**
 - **XYZ**
 - **NEZ**
5. Press **Transform**.
6. To select a format for the file to export, do one of the following:
 - Check the file format, and press **OK**.
 - Press **Format Manager** and customize a file format.
7. Select the target storage path.

6.3 Angle Converter

To start angle conversion, do the following:

1. To enter **Angle Converter** interface, press main menu **Tools** → **Angle Converter**:

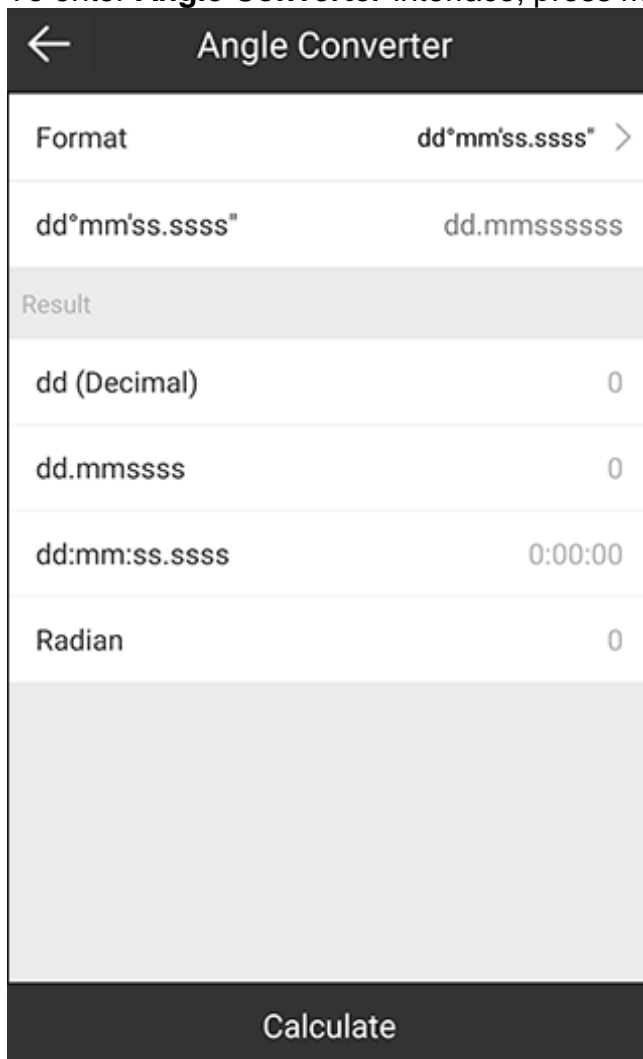

2. To select an angle format, press **Format**, and select one of the following:
 - dd(Decimal)
 - dd.mmssss
 - dd:mm:ss.ssss
 - dd:mm:ss.ssss"
 - Radian
3. Input an angle.
4. Press **Calculate**. The result shows in **Result** area.

6.4 Perimeter and Area

It is used to calculate perimeter and area of the graph formed by added points. At least 3 points that are not in a line are required.

To enter **Calculate Area** interface, press main menu **Tools** → **Perimeter and Area**:

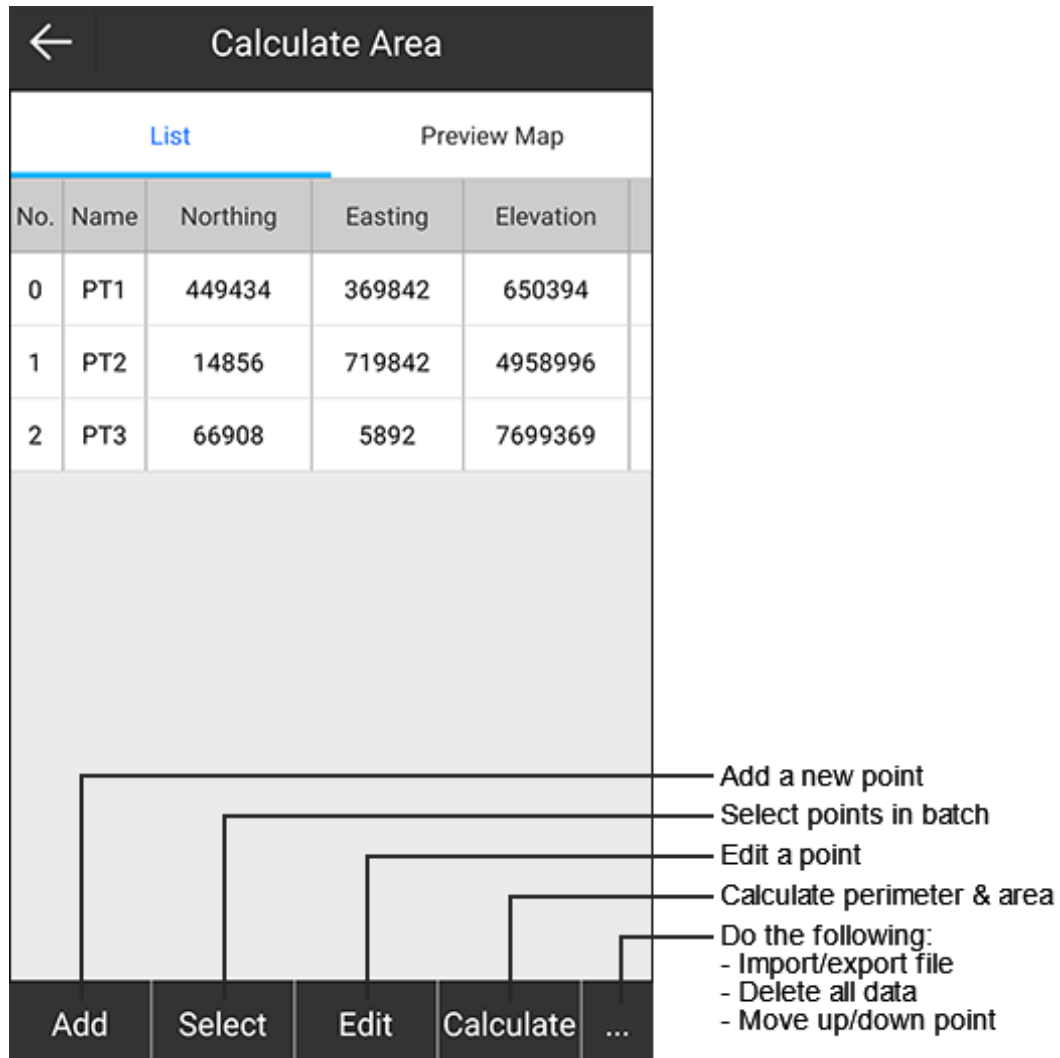

The screenshot shows the 'Calculate Area' interface. At the top, there is a back arrow and the title 'Calculate Area'. Below the title, there are two tabs: 'List' (selected) and 'Preview Map'. The 'List' tab contains a table with the following data:

No.	Name	Northing	Easting	Elevation
0	PT1	449434	369842	650394
1	PT2	14856	719842	4958996
2	PT3	66908	5892	7699369

Below the table is a large grey area representing a map preview. At the bottom, there is a dark menu bar with five buttons: 'Add', 'Select', 'Edit', 'Calculate', and '...'. Callouts from the right side of the image point to these buttons with the following descriptions:

- Add a new point
- Select points in batch
- Edit a point
- Calculate perimeter & area
- Do the following:
 - Import/export file
 - Delete all data
 - Move up/down point



6.4.1 Add a New Point

To add a new point, do the following:

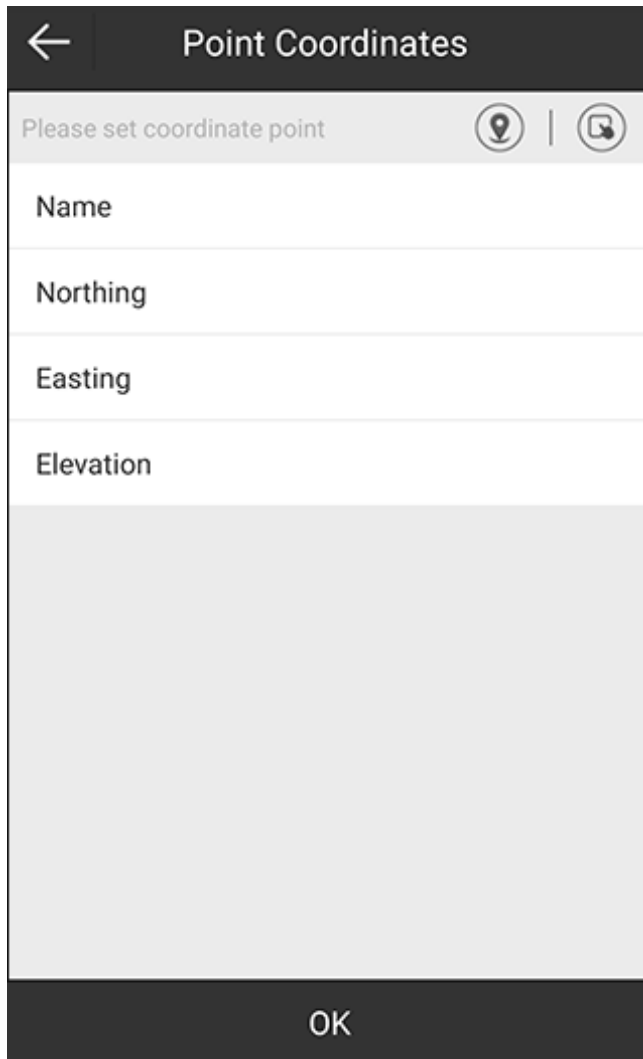
1. Press **Add. Point Coordinates** interface shows:



2. To set coordinates of the point, do one of the following:

- To use the current GPS coordinates, press , set antenna parameters and a point name.
- To select a point from the point database, press  and select the target point.
Alternatively, you can press **Select** in **Calculate Area** interface, and select a point from the point database.
- To manually input coordinates, set values of **Northing**, **Easting** and **Elevation**.

3. Press **OK**.

6.4.2 Edit a Point

To edit a point, do the following:

1. Select the target point, and press **Edit**.
2. Edit name and coordinates of this point.

6.4.3 Calculate Perimeter and Area

To calculate perimeter and area, press **Calculate**. The result shows:

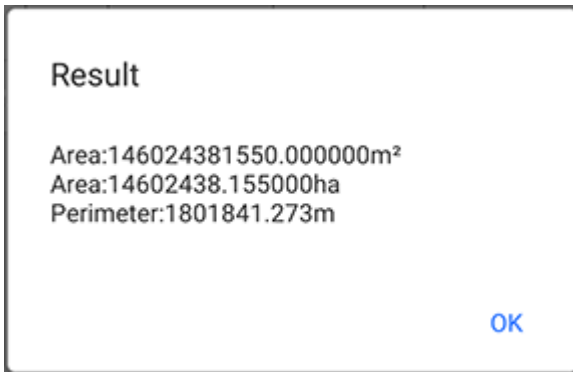



6.5 COGO Calculation

It is used to calculate distances, azimuths, point positions and other coordinate geometry (COGO) functions by the following methods:

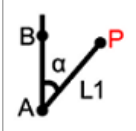
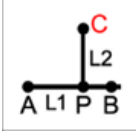
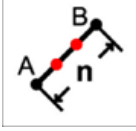
Method	Known information	Calculate
Coordinate inverse calculation	<p>A, B</p>	AB(2D), azimuth A → B(α), elevation difference, ratio of slope, slope angle, and AB (3D)
Point calculation line	<p>A, B, C</p>	AC(2D), BC(2D), AP(2D), BP(2D), PC(2D), α , β
Great-circle distance	<p>Latitude, longitude and altitude for point A and B</p>	Great-circle distance of AB
Two lines angle	<p>A, B, O</p>	Clockwise angle α
Intersection calculation	<p>A and B (on 1st straight line), C and D (on 2nd straight line)</p>	P and angle of the two lines
Resection	<p>A, B, L1, L2</p>	P
Forward intersection	<p>A, B, α, β</p>	P

Method	Known information	Calculate
Coordinate positive calculation 	A, B, L1, α	P
Offset point calculation 	A, B, L1, L2	C
Equal point calculation 	A, B (AB is divided into multiple parts by certain distance.)	Each divided points

To start COGO calculation, do the following:

1. To enter **COGO Calculation** interface, press main menu **Tools** → **COGO Calculation**.
2. Select the target method.
3. To set coordinates of points, do one of the following:
 - To use the current GPS coordinates, press , set antenna parameters and a point name.
 - To select a point from the point database, press  and select the target point.
 - To manually input coordinates, set values of **Northing**, **Easting** and **Elevation**.
4. Press **Calculate**. The result shows in **Result** area.

6.6 Calculator

It is used for the convenience of some simple data calculation.

To use the calculator, press main menu **Tools** → **Calculator** to enter **Calculator** interface:



6.7 External Radio Configuration

Before setting external radio configuration, make sure the receiver is disconnected.

To set external radio configuration, do the following:

1. To enter **Radio Mode** interface, press main menu **Tools** → **External Radio Configuration**:

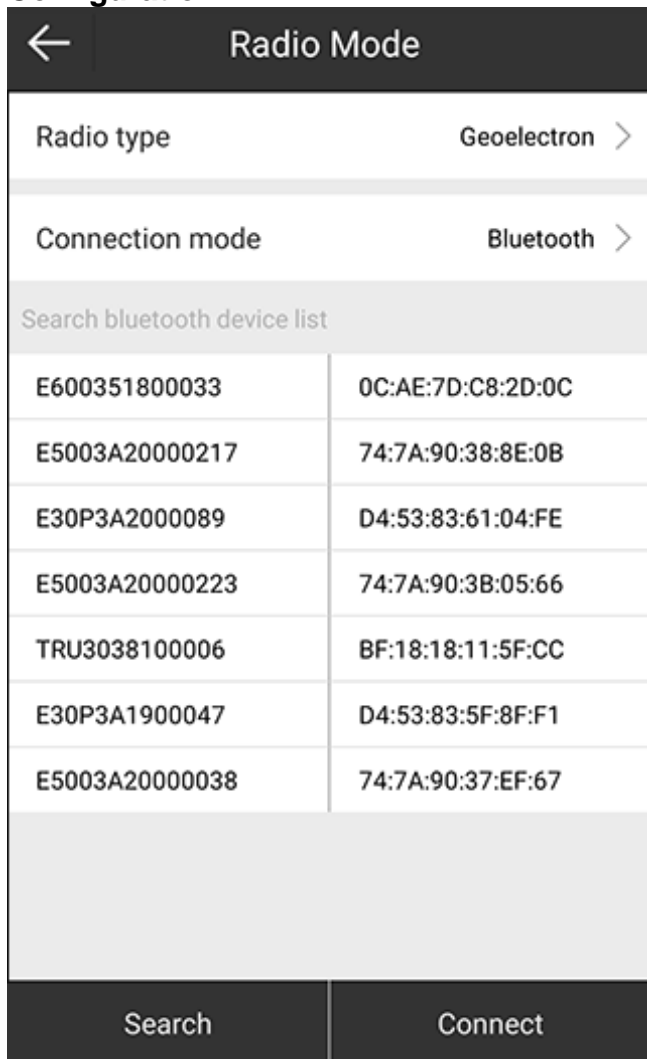

2. Select a radio type, and connection mode.
3. Press **Search**. SurPad automatically searches all devices with Bluetooth on.
4. Select the target device, and press **Connect**. **Search** button turns into **Settings** button when the connection succeeds.

5. Press **Settings. Functional Selection** interface shows:

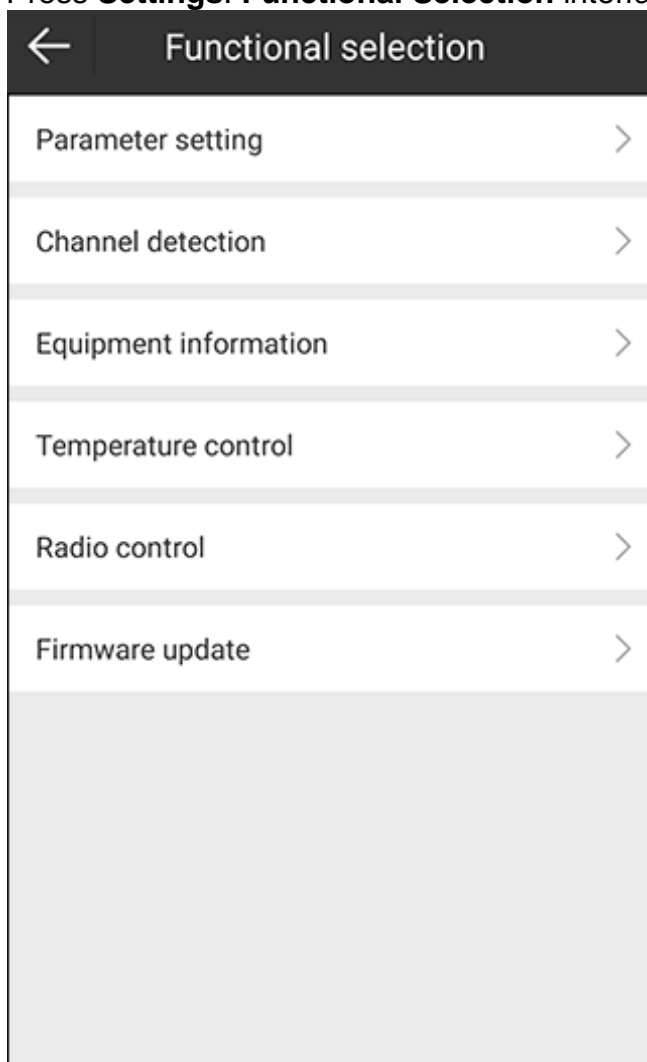

6. To finish parameter settings, do the following:
- Press **Parameter setting**. **Parameter setting** interface shows:

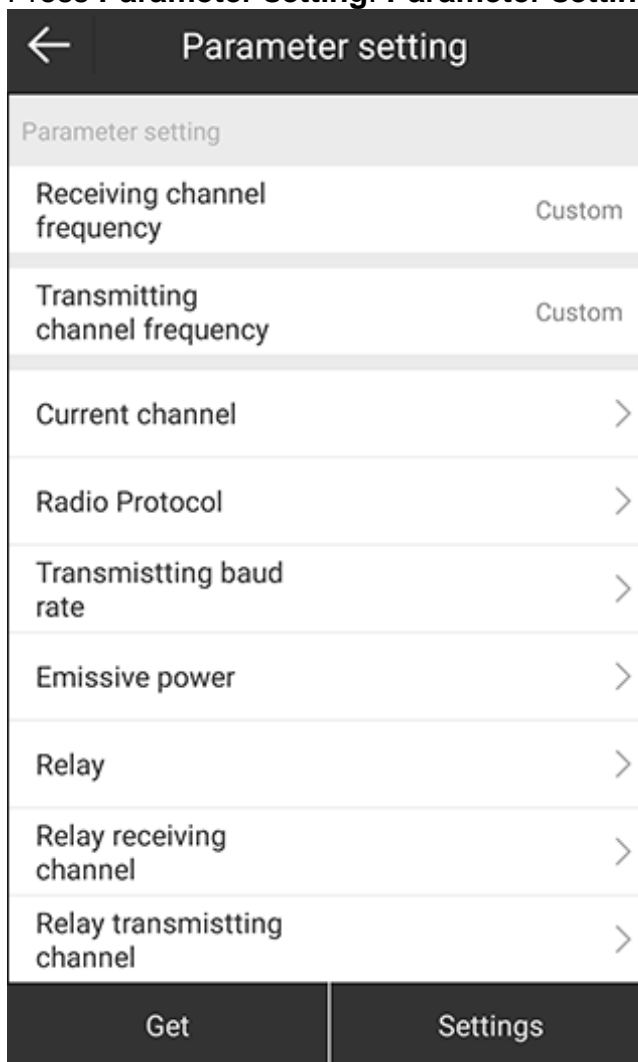

b. To obtain parameters of the current connected external radio, press **Get**:

Parameter setting

Receiving channel frequency Custom >

1:	441.000000	2:	442.000000
3:	443.000000	4:	444.000000
5:	445.000000	6:	446.000000
7:	447.000000	8:	445.000000

Transmitting channel frequency Custom >

1:	441.000000	2:	442.000000
3:	443.000000	4:	444.000000
5:	445.000000	6:	446.000000
7:	447.000000	8:	445.000000

Get Settings

c. After the configuration is set, press **Settings**.

d. **Optional:** Customize parameters of the current external radio.

7. To start a channel test, do the following:



CAUTION: an external radio antenna is required.

a. Press **Channel detection**. **Channel Detection** interface shows:

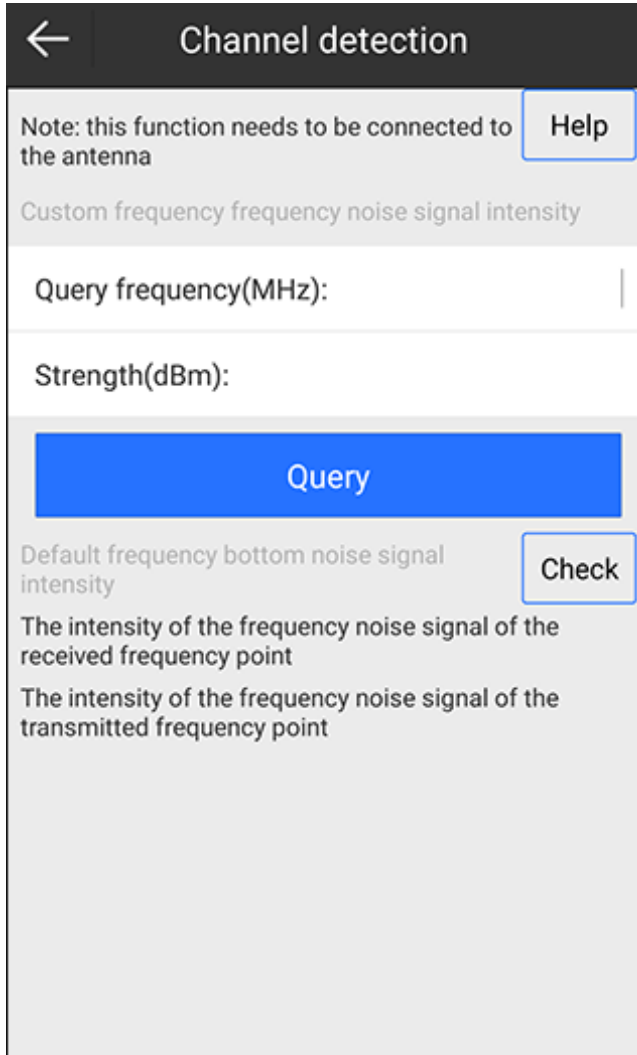

b. **Optional:** To check help information, press **Help**.

- Signal is stronger: ≥ -95 dBm
- Signal is weak: -105 dBm ~ -95 dBm
- Signal is very weak (no signal): ≤ -105 dBm

Signal is stronger indicates that the channel is in use. It is suggested to skip the channel and use channels that are in range **Signal is very weak (no signal)**.

c. Input the query frequency, and press **Query**.

If the strength shows weak, it indicates that the channel is accessible.

- d. To acquire the intensity of the frequency noise signal of the received and transmitted frequency point, press **Check**:

←
Channel detection

Default frequency bottom noise signal intensity Check

The intensity of the frequency noise signal of the received frequency point

1 [463.125 MHz] :	Very weak(-117.5 dBm)
2 [464.125 MHz] :	Very weak(-117.375 dBm)
3 [465.125 MHz] :	Very weak(-117.125 dBm)
4 [466.125 MHz] :	Very weak(-116.5 dBm)
5 [463.625 MHz] :	Very weak(-117.375 dBm)
6 [464.625 MHz] :	Very weak(-117.5 dBm)
7 [465.625 MHz] :	Very weak(-117.25 dBm)
8 [466.625 MHz] :	Very weak(-116.875 dBm)

The intensity of the frequency noise signal of the transmitted frequency point

1 [441.0 MHz] :	Very weak(-116.625 dBm)
2 [442.0 MHz] :	Very weak(-116.125 dBm)

8. To check the equipment information, press **Equipment information** in **Functional Selection** interface, and press **Get** in **Equipment Information** interface. SurPad automatically gets equipment information:

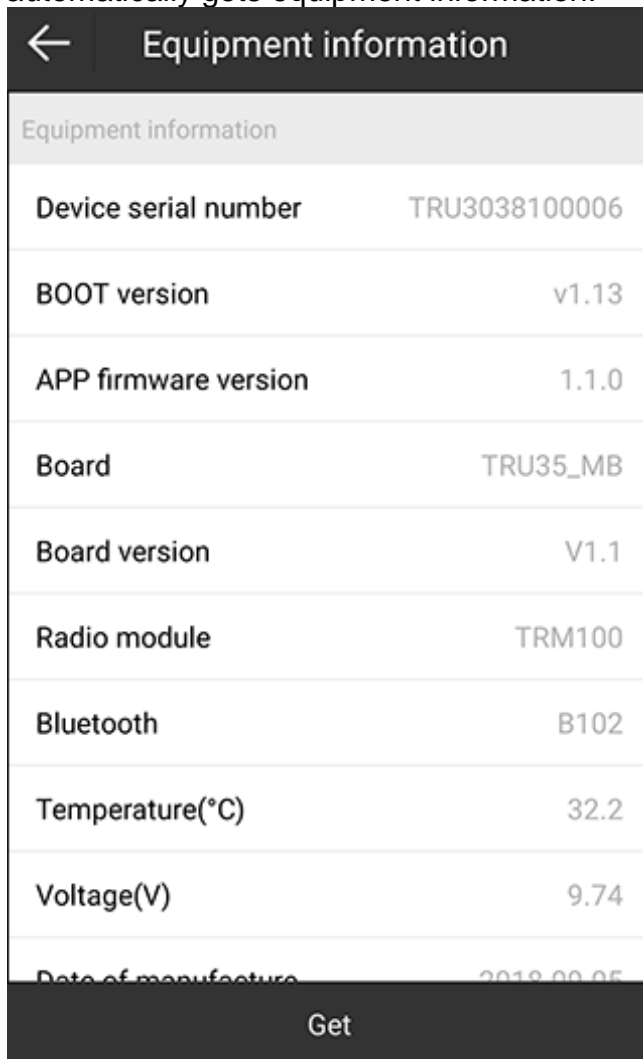

Equipment information	
Device serial number	TRU3038100006
BOOT version	v1.13
APP firmware version	1.1.0
Board	TRU35_MB
Board version	V1.1
Radio module	TRM100
Bluetooth	B102
Temperature(°C)	32.2
Voltage(V)	9.74
Date of manufacture	2019-09-05

Get

9. To set temperature control, do the following:
- Press **Temperature control** in **Functional Selection** interface.
Temperature Control interface shows:

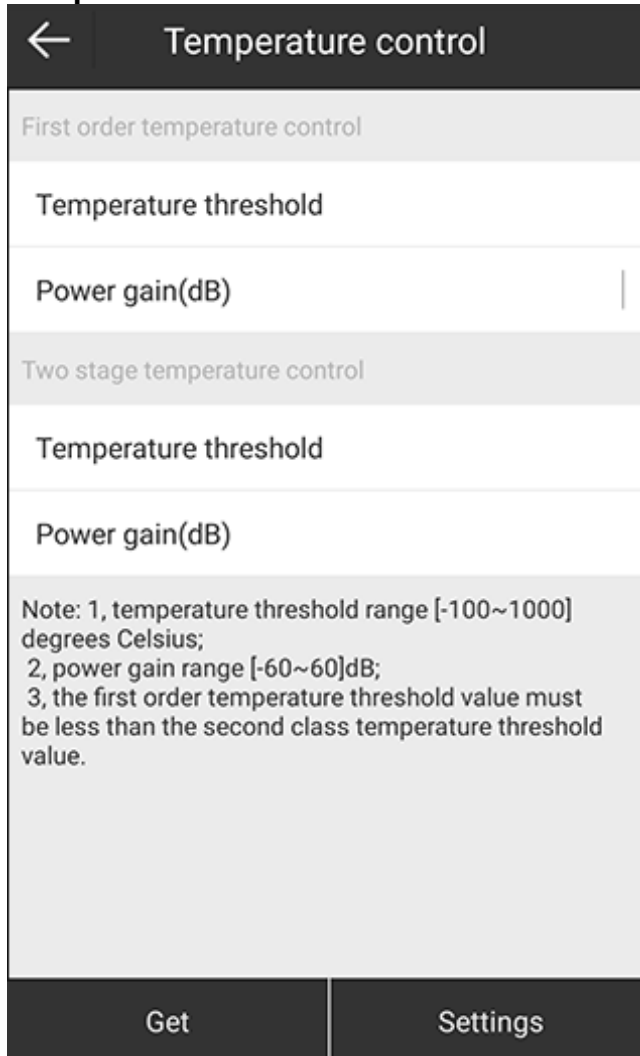

Temperature control

First order temperature control

Temperature threshold

Power gain(dB)

Two stage temperature control

Temperature threshold

Power gain(dB)

Note: 1, temperature threshold range [-100~1000] degrees Celsius;
 2, power gain range [-60~60]dB;
 3, the first order temperature threshold value must be less than the second class temperature threshold value.

Get Settings

- To view temperature control of the current connected external radio, press **Get**.
- Optional:** Customize temperature control of the current external radio.
 - Temperature threshold range: -100 °C ~1000 °C.
 - Power gain: -60 dB ~ 60 dB.



WARNING: The temperature threshold of the first order should be smaller than that of two stage.

- Press **Settings** for saving temperature control.

10. To set radio control, do the following:

- a. Press **Radio control** in **Functional Selection** interface. **Radio Control** interface shows:

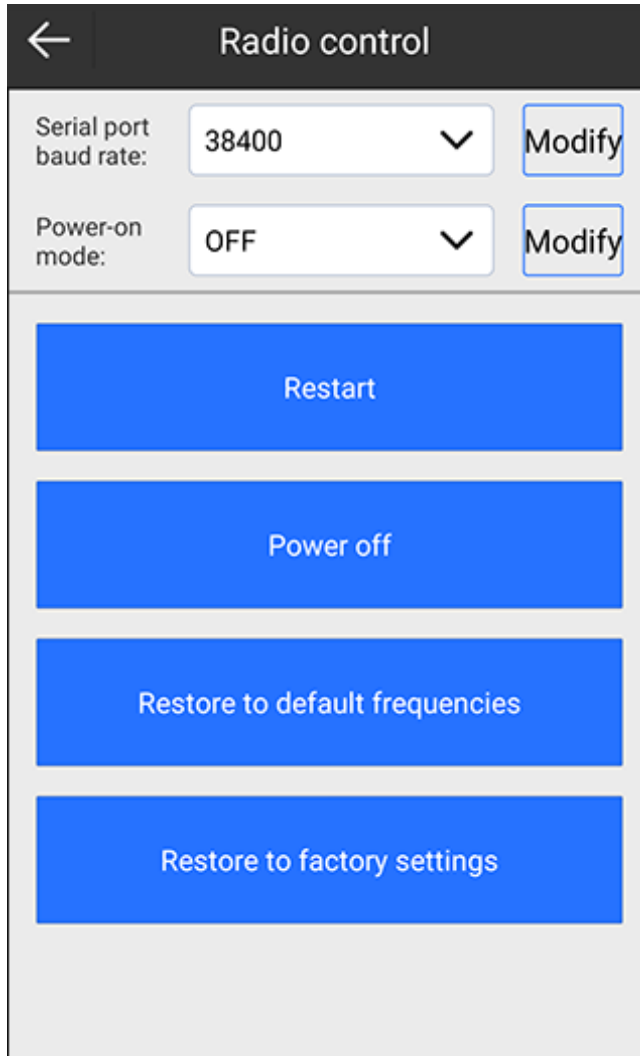

- b. To change the serial port baud rate, select baud and press **Modify**.
- c. To select whether to enable power-on mode, select a selection and press **Modify**.
- d. Do one of the following based on your own needs:
- To restart the external radio, press **Restart**.
 - To power off the external radio, press **Power off**.
 - To restore the changed frequency to its default settings, press **Restore to default frequencies**.
 - To eliminate all user-defined information for the external radio, press **Restore to factory settings**.

11. To update firmware, press **Firmware update** in **Functional Selection** interface, and select a firmware file with *.bin format in **Firmware Update** interface:

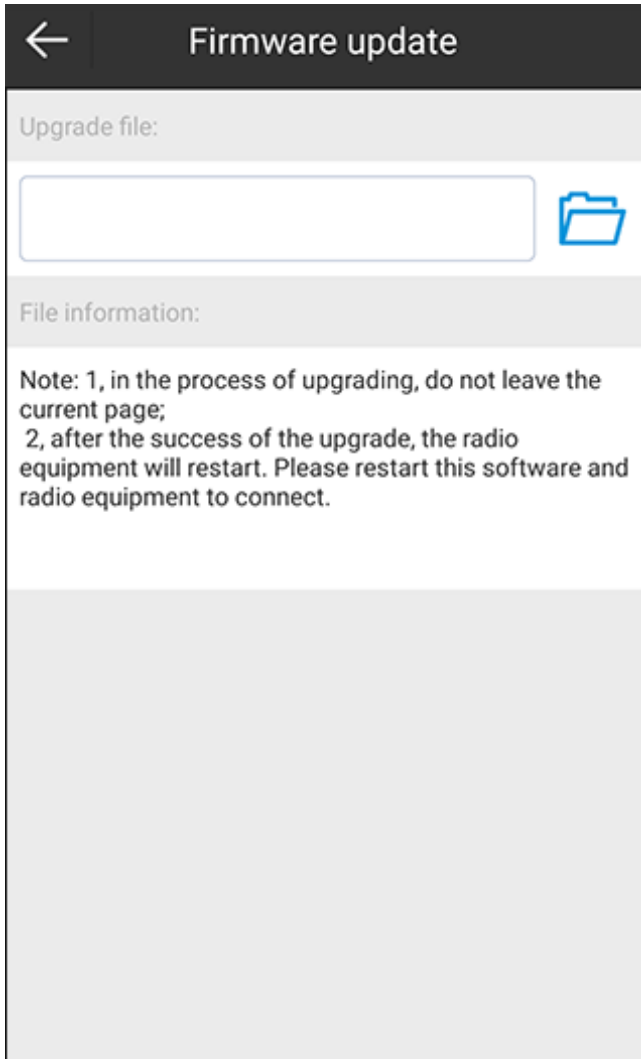

6.8 Volume Calculation

It is used for land levelling, roadbed excavation, excavation for civil air defense projects, ground filling, roadbed filling and pit backfilling with small-scale, high-precision landform.

To start volume calculation, do the following:

1. To enter **Volume Calculation** interface, press main menu **Tools** → **Volume Calculation**:

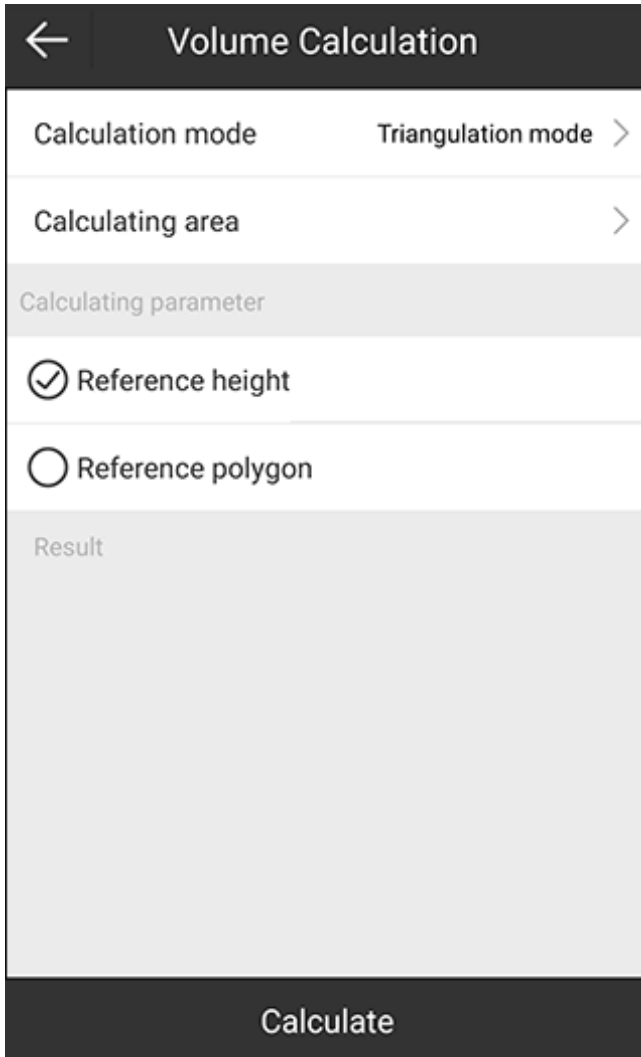

The screenshot shows the 'Volume Calculation' interface. At the top, there is a back arrow and the title 'Volume Calculation'. Below the title, there are several settings:

- Calculation mode:** Set to 'Triangulation mode' with a right-pointing chevron.
- Calculating area:** A field with a right-pointing chevron.
- Calculating parameter:** A section header.
- Reference height:** Selected with a checked radio button.
- Reference polygon:** Unselected with an unchecked radio button.
- Result:** A large, empty grey rectangular area for displaying the calculation result.

At the bottom of the screen, there is a dark grey bar with the 'Calculate' button.

2. To enter **Polygon Database** interface, press **Calculating area**:



No.	Name	Full Path
1	test	Internal Storage/SurPad/Project/20210720/

New Edit Delete Import OK

3. To add a new area, press **New**:

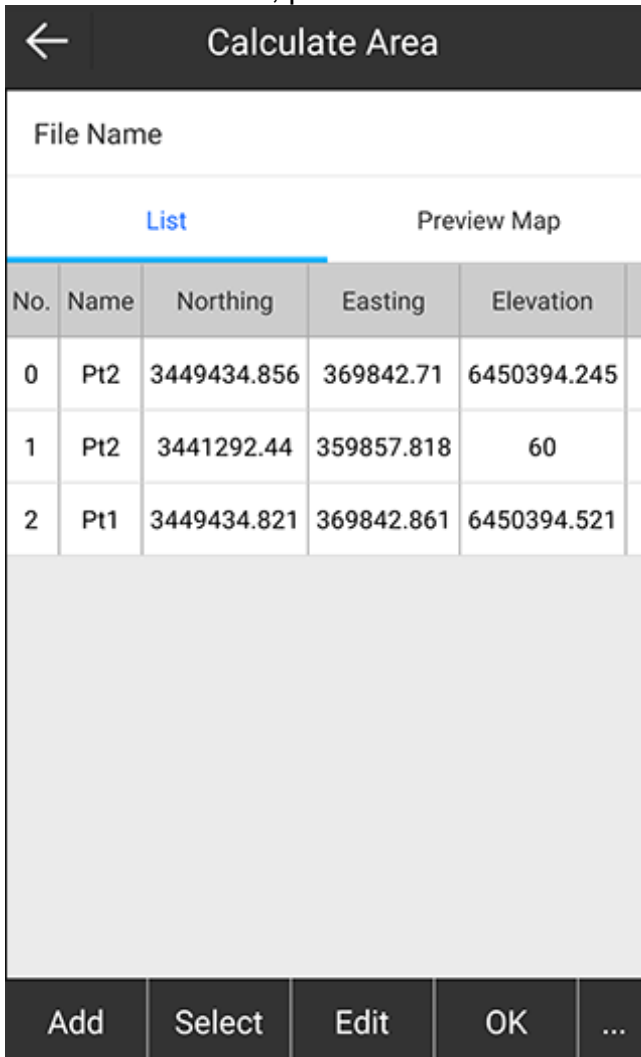

No.	Name	Northing	Easting	Elevation
0	Pt2	3449434.856	369842.71	6450394.245
1	Pt2	3441292.44	359857.818	60
2	Pt1	3449434.821	369842.861	6450394.521

4. Set a file name.
5. To get coordinates of points, do one of the following, and press **OK**:
- To obtain the current GPS data, select from the point database, or manually set coordinates, press **Add**, and do related operations.
 - To select points from the point database in batch mode, press **Select**, and select the target points.
 - To directly import a file (*.dat, *.csv, *.txt), press ... → **Import** and select the target file.

The interface returns to **Polygon Database** interface.

6. Select the target polygon, and press **OK**. The interface returns to **Volume Calculation** interface.
7. To select a way to calculate the set area, do one of the following:
- Set the reference height, and press **Calculate**.
 - Press **Reference polygon**, and select the target polygon in polygon database, and press **Calculate**.

The result shows in **Result** area:

← Volume Calculation

Calculation mode Triangulation mode >

Calculating area test.csv >

Calculating parameter

Reference height 50 ✕

Reference polygon

Result

Fill	0.0000m ³
Cut	3409614315.2036m ³
Surface area	499583.6625m ²

Calculate

6.9 Add Offsets to Points at Specified Period

It is usually used when data is collected without localization and it needs to calibrate data of a certain period after collection.

To add offsets to points at specified period, do the following:

1. To enter **Add Offsets to Points at Specified Period** interface, press main menu **Tools** → **Add Offsets to Points at Specified Period**.
2. To calculate the localization parameters, press **Marker Point Calibration**, set coordinates of the known point and the current WGS84 coordinates, and press **Calculate**. The result shows:

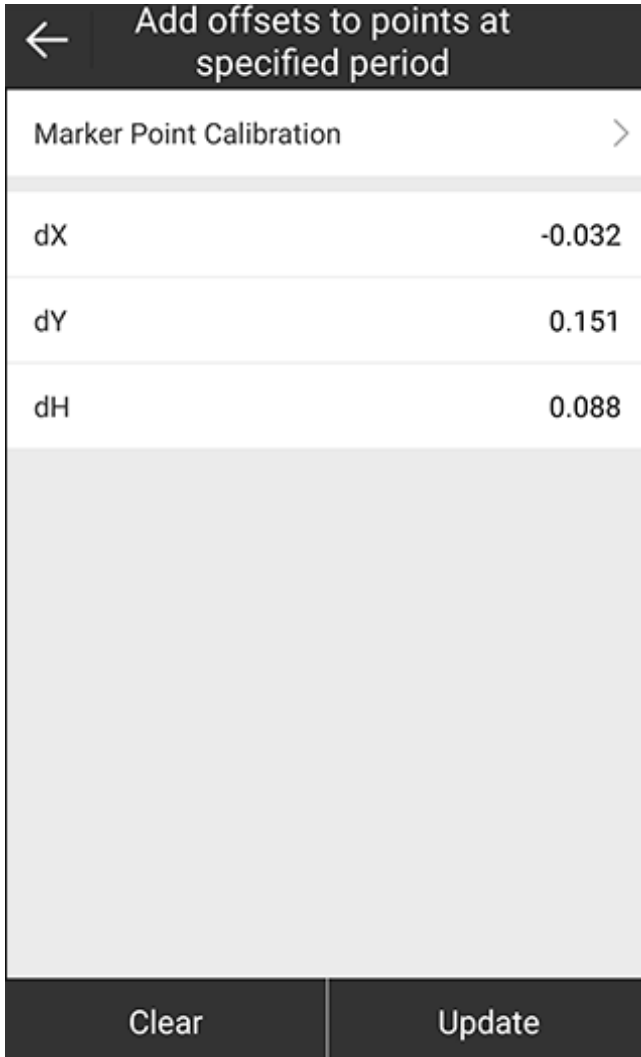

Add offsets to points at specified period	
Marker Point Calibration >	
dX	-0.032
dY	0.151
dH	0.088
<div style="display: flex; justify-content: space-around;"> Clear Update </div>	

3. Press **Update**. The following interface shows:

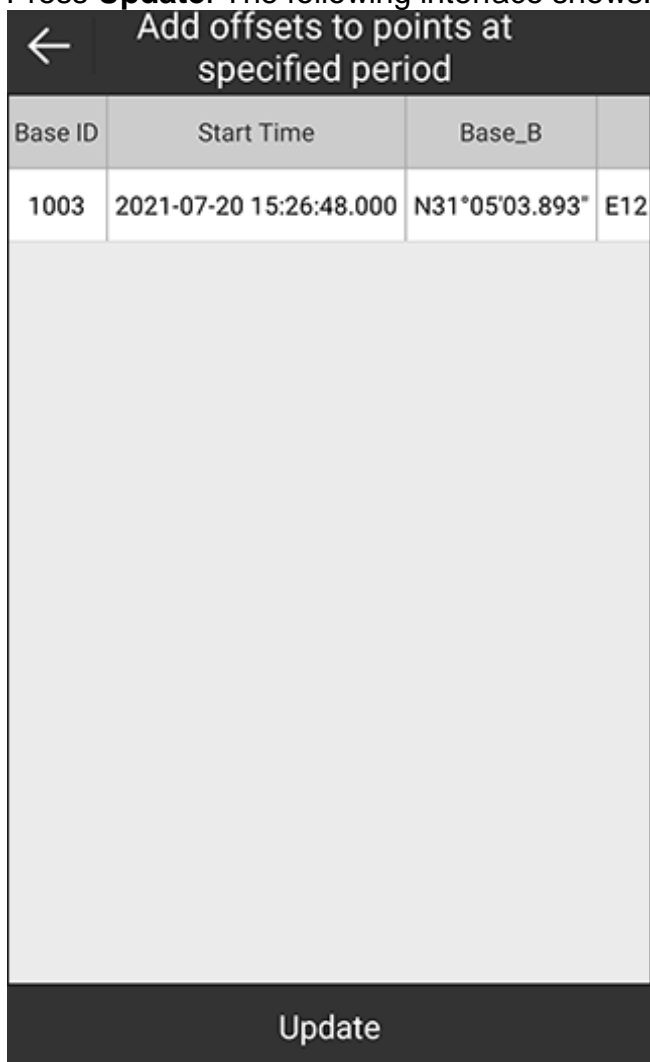

4. Select the target data, and press **Update**. The following interface shows:

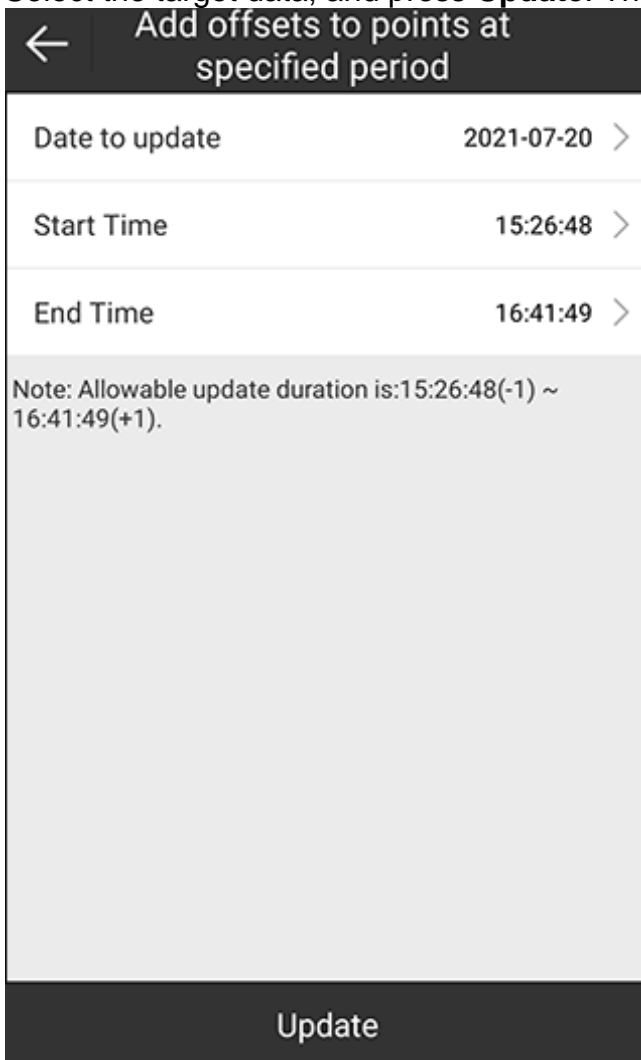

Add offsets to points at specified period	
Date to update	2021-07-20 >
Start Time	15:26:48 >
End Time	16:41:49 >
Note: Allowable update duration is:15:26:48(-1) ~ 16:41:49(+1).	
Update	

5. To calibrate date of a certain period, set the data to update, start time and end time, and press **Update**.

6.10 FTP Shared Data

It is used to share data between SurPad and your PC in real time through FTP.

Before sharing data through FTP, make sure SurPad and your PC are in the same local area network.

To share data through FTP, do the following:

1. To enter **FTP Shared Data** interface, press main menu **Tools** → **FTP Shared Data**:

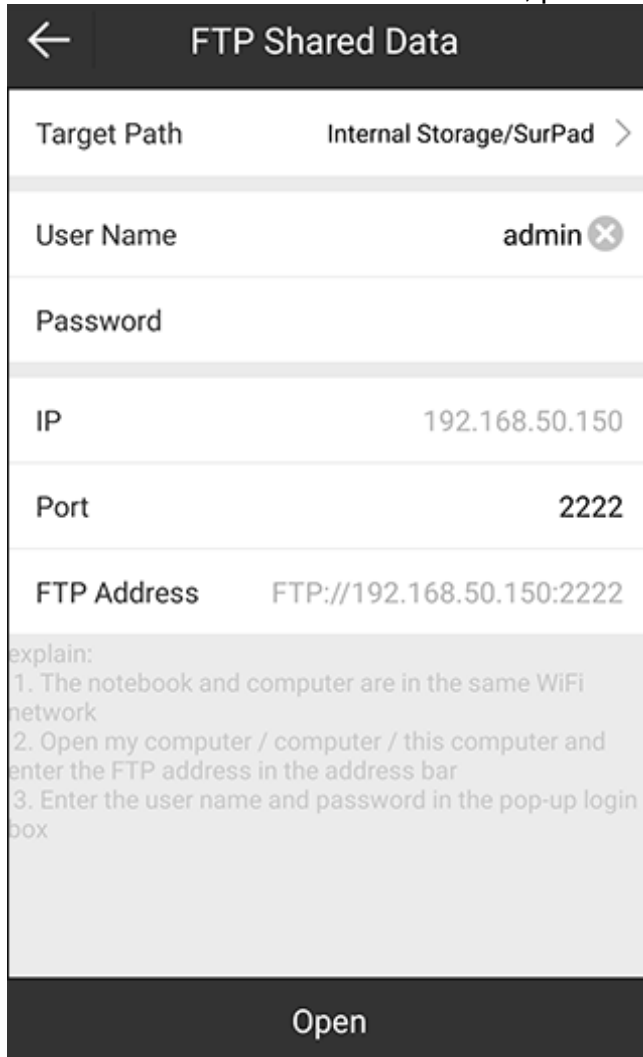

2. Select the target path.
3. Set user name and password.
4. Set port. The FTP address changes in real time.
5. To save settings, press **Open**.
6. Input the FTP address into the address bar of your PC:

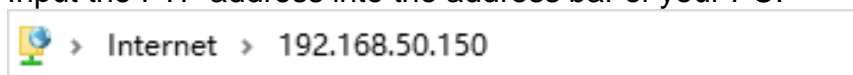

7. Input the set user name and password to access:

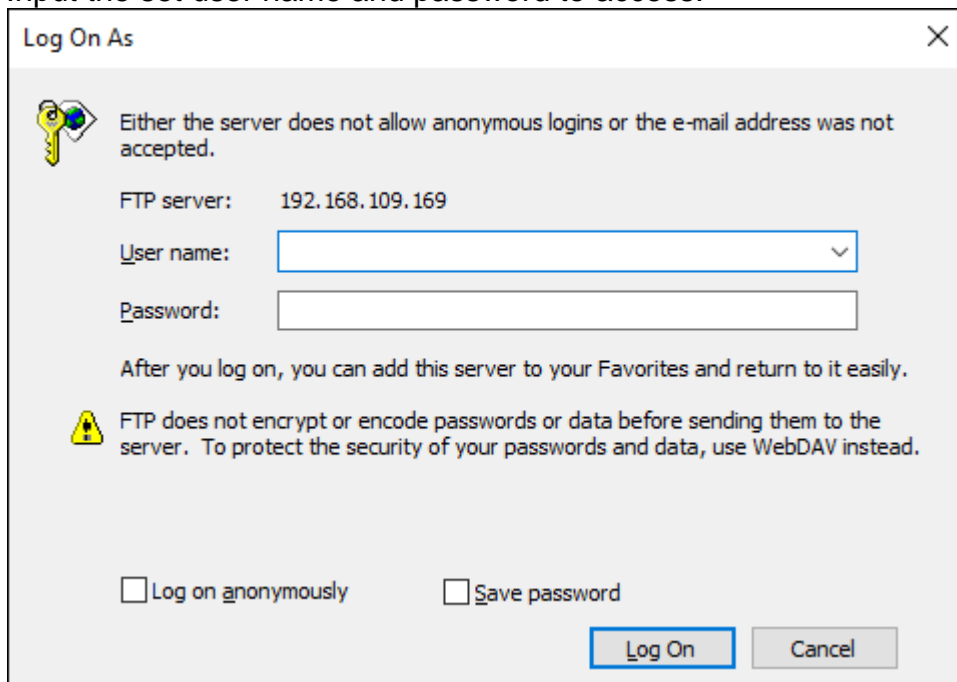

Log On As

Either the server does not allow anonymous logins or the e-mail address was not accepted.

FTP server: 192.168.109.169

User name:

Password:

After you log on, you can add this server to your Favorites and return to it easily.

FTP does not encrypt or encode passwords or data before sending them to the server. To protect the security of your passwords and data, use WebDAV instead.

Log on anonymously Save password

Log On Cancel

8. Start sharing files.

6.11 Share

It is used to share files in both device memory and SurPad memory to other Apps in your device.

The Apps that can be shared depend on the software you have installed, and SurPad 4. 2 is only responsible for calling the Android interface.

To share files, do the following:

1. Press main menu **Tools** → **Share**.
2. Select the target file in the target directory, and press **OK**.
3. Select the target App in your device.



6.12 Grid to Ground

It is used to calculate the scale factor between the total station and RTK in high attitude area, so as to achieve coordinate conversion.

To start grid to ground, do the following:

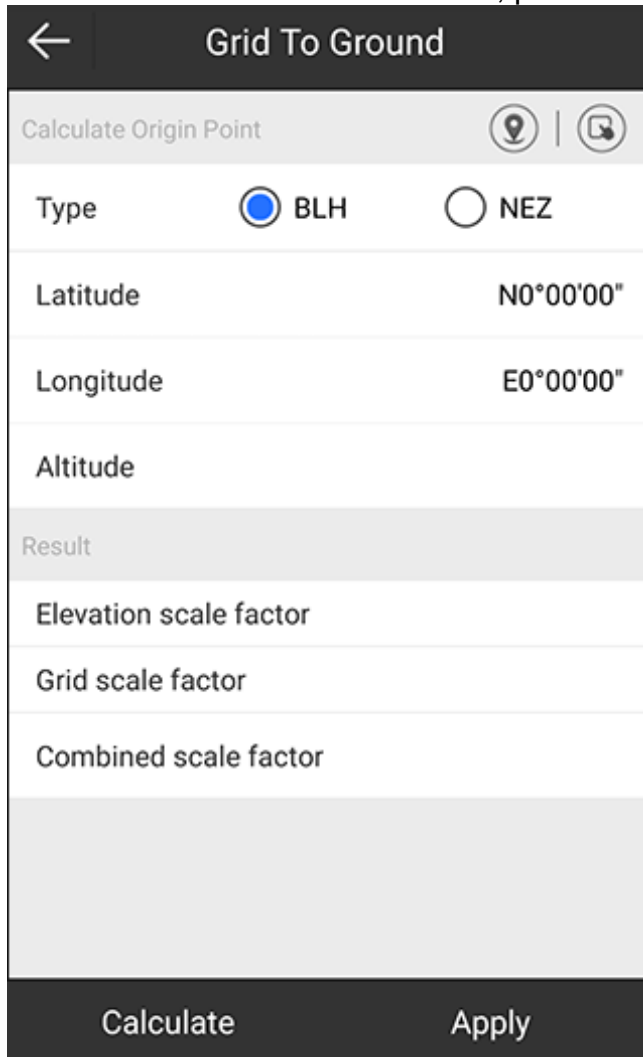
1. To enter **Grid to Ground** interface, press main menu **Tools** → **Grid to Ground**:



2. Select a type of the source coordinate:
 - **BLH**: including latitude, longitude and altitude.
 - **NEZ**: including northing, easting and elevation.
3. To set coordinates of a point, do one of the following:
 - To use the current GPS coordinates, press , set antenna parameters and a point name.
 - To select a point from the point database, press  and select the target point.
 - To manually input coordinates, set values of **Latitude**, **Longitude** and **Altitude**, or **Northing**, **Easting** and **Elevation**.

4. Press **Calculate**. The result shows in **Result** area:

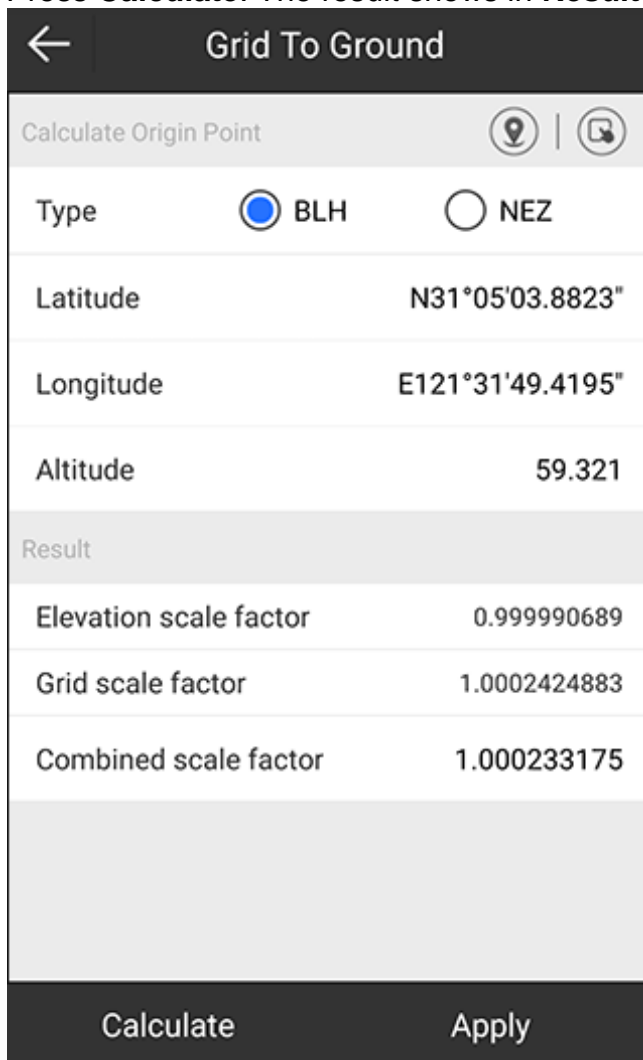

The screenshot shows a mobile application interface titled "Grid To Ground". At the top, there is a back arrow and the title. Below the title is a section for "Calculate Origin Point" with location and map icons. The "Type" is set to "BLH" (selected with a blue radio button) and "NEZ" (unselected with a white radio button). The "Latitude" is "N31°05'03.8823\"", "Longitude" is "E121°31'49.4195\"", and "Altitude" is "59.321". Below this is a "Result" section containing three rows of data: "Elevation scale factor" (0.999990689), "Grid scale factor" (1.0002424883), and "Combined scale factor" (1.000233175). At the bottom, there are two buttons: "Calculate" and "Apply".

Calculate Origin Point	
Type	<input checked="" type="radio"/> BLH <input type="radio"/> NEZ
Latitude	N31°05'03.8823"
Longitude	E121°31'49.4195"
Altitude	59.321
Result	
Elevation scale factor	0.999990689
Grid scale factor	1.0002424883
Combined scale factor	1.000233175

5. To apply the result, press **Apply**.

To view the calculated ground coordinates, press main menu **Project** → **Points Database**, and select the target point, and press **Details**:

← Point Details	
Title	Content
Easting	369854.219
Elevation	0.8
X	-2859097.112
Y	4660052.211
Z	3273938.437
Type	Survey Point
Combined Factor	1.0002330914
Ground N	3449427.287
Ground E	369854.217
Ground H	0.8
Record Mode	Topo Point

Photo And Sketch

*To be the leading provider of high-precision professional,
solution & service in the global geospatial industry*



Shanghai eSurvey GNSS Co., Ltd.

Address: Building 4, No.651 Wanfang Rd, Pujiang Town, Minhang District, Shanghai, China

E-mail: Sales: info@esurvey-gnss.com Support: support@esurvey-gnss.com

Hot-line: +86 21 54467213

Website: <https://esurvey-gnss.com/>