

E3L TOTAL STATION

USER GUIDE



V1.1

Copyright © Shanghai eSurvey GNSS Co., Ltd. 2021. All rights reserved.

No part of this document may be reproduced or transmitted in any form or by any means without prior written consent of Shanghai eSurvey GNSS Co., Ltd.

Trademarks and Permissions

 and other eSurvey trademarks are trademarks of Shanghai eSurvey GNSS Co., Ltd.

All other trademarks and trade names mentioned in this document are the property of their respective holders.

Notice

The purchased products, services and features are stipulated by the contract made between eSurvey and the customer. All or part of the products, services and features described in this document may not be within the purchase scope or the usage scope.

The information in this document is subject to change without notice. Every effort has been made in the preparation of this document to ensure accuracy of the contents, but all statements, information, and recommendations in this document do not constitute a warranty of any kind, express or implied.

Contents

1 Before You Start	1
1.1 Precautions for Safe Operation.....	1
1.1.1 Warning	1
1.1.2 Caution	1
1.2 Exceptions from Responsibility.....	2
1.3 Safety Standards for Laser.....	2
2 E3L at a Glance	3
2.1 Overview	3
2.2 Trigger Key	3
2.3 Operating Panel.....	4
2.4 Display	5
2.4.1 Soft Keys	5
2.4.2 Symbols.....	6
2.5 Input Mode	7
2.6 Battery	7
2.6.1 Replace and Mount the Battery	8
2.6.2 Recharge the Battery	8
3 Quick Start	9
3.1 Set up the Instrument	10
3.2 Center with the Laser Plummet.....	10
3.3 Do Levelling-up	11
3.3.1 Do Basic Levelling-up	11
3.3.2 Do Accurate Levelling-up.....	11
3.3.2.1 Do Accurate Levelling-up with the Tubular Level	12
3.3.2.2 Do Accurate Levelling-up with the Electronic Level on the Screen	12
3.4 Set EDM.....	13
3.5 Start Measurement	13
4 Function Key.....	14
4.1 Level / Plummet.....	14
4.2 Target Offset.....	14
4.3 Target Set.....	15
4.4 Delete Last Record.....	15
4.5 Height Transfer.....	16
4.6 Hidden Point	17

4.7 Free-Coding	19
4.8 Laser Pointer	20
4.9 Check Tie	20
4.10 Main Settings	21
4.11 Tracking	21
4.12 Light On/Off	21
4.13 Units	21
5 Menu Key.....	22
5.1 Overview	22
5.2 Program Menu	23
5.2.1 Surveying.....	24
5.2.1.1 Set a Job.....	24
5.2.1.2 Set the Station.....	25
5.2.1.3 Set the Orientation	25
5.2.1.4 Start Survey	26
5.2.2 Stake out	27
5.2.2.1 Set a Job.....	27
5.2.2.2 Set the Station.....	27
5.2.2.3 Set the Orientation	27
5.2.2.4 Start Staking out.....	28
5.2.3 Free Station	31
5.2.3.1 Set a Job.....	32
5.2.3.2 Set Accuracy Limit	32
5.2.3.3 Start Free Station	33
5.2.4 COGO.....	34
5.2.4.1 Set a Job.....	35
5.2.4.2 Set the Station.....	35
5.2.4.3 Set the Orientation	35
5.2.4.4 Start COGO.....	35
5.2.4.4.1 Set Inverse or Traverse Computation	35
5.2.4.4.1.1 Set Inverse Computation.....	36
5.2.4.4.1.2 Set Traverse Computation	37
5.2.4.4.2 Set Intersections.....	38
5.2.4.4.2.1 Set Bearing-bearing	38
5.2.4.4.2.2 Set Bearing-distance.....	39
5.2.4.4.2.3 Set Distance-distance	40
5.2.4.4.2.4 Set Four Points	41
5.2.4.4.3 Set Offset.....	42
5.2.4.4.3.1 Set Distance-offset.....	42
5.2.4.4.3.2 Set Point by.....	43
5.2.4.4.4 Set Extension	44
5.2.5 Tie Distance.....	45
5.2.5.1 Set a Job.....	46
5.2.5.2 Set the Station.....	46
5.2.5.3 Set the Orientation	46

5.2.5.4 Start Tie Distance.....	46
5.2.6 Area and Volume	48
5.2.6.1 Set a Job	50
5.2.6.2 Set the Station.....	50
5.2.6.3 Set the Orientation	50
5.2.6.4 Start Area and Volume	50
5.2.7 Remote Height.....	51
5.2.7.1 Set a Job	52
5.2.7.2 Set the Station.....	52
5.2.7.3 Set the Orientation	52
5.2.7.4 Start Remote Height.....	52
5.2.8 Reference Line/Arc	53
5.2.8.1 Set a Job	53
5.2.8.2 Set the Station.....	53
5.2.8.3 Set the Orientation	53
5.2.8.4 Start Reference Line/Arc.....	54
5.2.8.4.1 Set Reference Line	54
5.2.8.4.2 Set Reference Arc	56
5.2.9 Construction	59
5.2.9.1 Set a Job	59
5.2.9.2 Set EDM.....	59
5.2.9.3 Set the New Construction Site	59
5.2.9.4 Continue the Previous Site.....	60
5.2.10 Lead Measure	61
5.2.10.1 Set a Job	61
5.2.10.2 Start Lead Measurement.....	61
5.2.10.2.1 Set the Lead	62
5.2.10.2.2 Set the Station	63
5.2.10.2.3 Measure the Point.....	63
5.2.10.2.4 Calculate the Lead.....	64
5.2.10.2.5 View Data	65
5.2.10.2.6 Transfer Data.....	65
5.2.11 2D-Road	65
5.2.11.1 Set a Job	66
5.2.11.2 Set the Station.....	66
5.2.11.3 Set the Orientation	66
5.2.11.4 Start 2D-Road	66
5.2.11.4.1 Define Road.....	67
5.2.11.4.1.1 Set a Reference Point	67
5.2.11.4.1.2 Define Road(2D) Data.....	68
5.2.11.4.1.2.1 Set Main Point	69
5.2.11.4.1.2.2 Set Intersection Point	70
5.2.11.4.2 Set Road Staking out.....	71
5.2.11.4.3 View Data	72
5.2.11.4.4 Transfer Data.....	73
5.3 Setting Menu.....	74
5.4 EDM Menu	77
5.4.1 Common Parameters.....	77

5.4.2 Atmospheric Parameters	78
5.4.3 Times of Distance Measuring	79
5.4.4 Projection Scale.....	79
5.4.5 Signal Intensity	79
5.5 Job Menu.....	80
5.5.1 Job.....	80
5.5.2 Fixed points	81
5.5.3 Measurements.....	81
5.5.4 Codes	82
5.5.5 Initialize Memory.....	82
5.5.6 Memory Statistics	83
5.5.7 Memory Selection	83
5.5.8 USB	84
5.5.9 File Copy	84
5.5.10 DAT Data Change	84
5.6 Adjust Menu.....	85
5.6.1 Horizontal Collimation.....	85
5.6.2 Vertical Index.....	88
5.6.3 View Adjustment Value.....	90
5.6.4 Tilt Offset	90
5.7 Com Menu	92
5.8 Download Menu.....	93
5.9 Start Menu.....	94
5.10 Info Menu	95
6 Maintenance.....	96
6.1 Cleaning and Drying	96
6.2 Storage.....	96
6.3 Transportation	96
6.4 Check	96
7 Check and Correction.....	97
7.1 Instrument Constant	97
7.2 Tubular Level.....	98
7.3 Circular Level.....	98
7.4 Optical Sight of the Telescope.....	99
7.5 Laser Centering Device	99
7.6 Vertical Line of the Telescope Reticle	100
7.7 Collimation Error of the Instrument.....	101
7.8 Index Error of the Vertical Circle.....	101
7.9 Zero Position Error of the Tilt Offset	101
7.10 Optical Axis and Telescope Sighting Axis for Distance Measurement	101

8 Appendix	102
8.1 Atmospheric Correction Formula and Chart (Just for reference)	102
8.2 Correction for Refraction and Earth Curvature	103
8.3 Assembling and Disassembling for the Three-jaw Tribrach	104

1 Before You Start

Before you start, please carefully read this part.

1.1 Precautions for Safe Operation

For the safety of your product and prevention of injury to operators and other persons as well as prevention of property damage, please read this part carefully before using your product.

Precautions can be divided into the following types according to the degree of loss or injury in case of negligence or omission:

- **Warning:** Precautions requiring special attention. Ignoring this indication may possibly result in death or serious injury to the operator.
- **Caution:** Precautions mainly for informing, such as supplementary instructions and using limitations. Ignoring this indication may possibly result in personal injury or property damage.

1.1.1 Warning

- This instrument is only for qualified surveyor or professional users who have a good knowledge of surveying.
- Please wear the required protectors (safety shoes, helmet, etc.) when operating.
- Only e-Survey authorized distributors can disassemble or rebuild the instrument.
- Please do not collimate the sun directly. Otherwise, eye injury or blindness and objective damage may occur.
- Please do not cover the charger when charging. Otherwise, fire may occur.
- Please do not use wet battery or charger, defective power cable, socket or plug, and power cable and battery not specified by e-Survey. Otherwise, fire or electronic shock may occur.
- Please do not put the instrument close to burning gas or liquid and the battery in the fire or high temperature condition, and do not use the instrument in coal mine. Otherwise explosion may occur.
- Please avoid short circuit of the battery. Otherwise, fire may occur.
- Please avoid disturbance of severe electrostatic discharge. Otherwise, this instrument may have some degradation of performance like switching on/off automatically and so on.

1.1.2 Caution

- Please set up the instrument on the tripod, and make sure the connection between the tripod and instrument is firm. It is better to work with wooden tripod for the accuracy of measurement.
- Please correctly and carefully assemble the tribrach on the instrument for if it is not correctly or stably installed, the accuracy may be affected, and frequently check the tribrach to make sure all screws that connect the tribrach and alidade are tightly locked, and the central fixing screw is tight.
- When transporting, please try your best to lighten libration on the instrument.
- When carrying the instrument, please tightly hold the handle.

- The sharp temperature changing on the instrument or prism will shorten the distance measurement range. Therefore, after taking the instrument out from a condition in which the temperature is totally different from now, please wait for some time until the instrument adapts to the surrounding condition.
- Please do not take out the battery when the instrument is on, and replace the battery after powering off the instrument. Otherwise, the stored data may be lost.
- Please do not touch the instrument with wet hand. Otherwise, there is danger of electric shock.
- Please do not arbitrarily stand or seat on the carrying case, or turn over it. Otherwise, the instrument may be damaged.
- Please be careful of the tripod tiptoe when setting up or moving it.
- Please do not drop the instrument or the carrying case, or use defective belt, agraffe or hinge. Otherwise, the instrument may be damaged.
- Please do not touch liquid leaking from the instrument or battery. Otherwise, harmful chemicals could cause burn or blisters.

1.2 Exemption from Responsibility

You are expected to follow all operating instructions and regularly check the performance of this instrument.

The manufacturer assumes no responsibility for any damage and loss of profits caused by the following conditions:

- A faulty or intentional usage or misuse.
- Any disasters, such as earthquakes, storms, floods etc.
- A change of data, loss of data, an interruption of business etc.
- Wrong transport, or actions due to connecting with other products.
- Usage not explained in the user guide.

1.3 Safety Standards for Laser

E3L adopts the safe and visible laser on the basis of **Specification Standard of radiant products** (FDA CDRH.21CFR Part 1040.10 and 1040.11) and **Safety of laser products – parts 1: Equipment classification, requirements and user's guide** (IEC 60825-1:2001).

According to above standards, **E3L** is class IIIa/3R laser products. When the prism or reflective sheet is selected in **Config** mode as target, the output is equivalent to the safer class 1.

Warnings for Safety

To avoid permanent eye damage, please pay special attention to the following warnings:

- Never point the laser beam at other's eyes.
- Never directly look into the laser beam source.
- Never stare at the laser beam.
- Never look at the laser beam through a telescope or other optical devices.

2 E3L at a Glance

E3L is a high-quality electronic total station, designed for the construction site. Its innovative technology and simple operations make the daily surveying jobs easier. Undoubtedly, it is ideally suited for simple construction surveys and stake out tasks.

2.1 Overview

Each part of **E3L** is as follows:



2.2 Trigger Key

The trigger key has the following settings, activated in **SETS** menu:

- **ALL**
- **DIST**
- **OFF**

See [Setting Menu](#) for details.

2.3 Operating Panel

The operating panel is as follows:

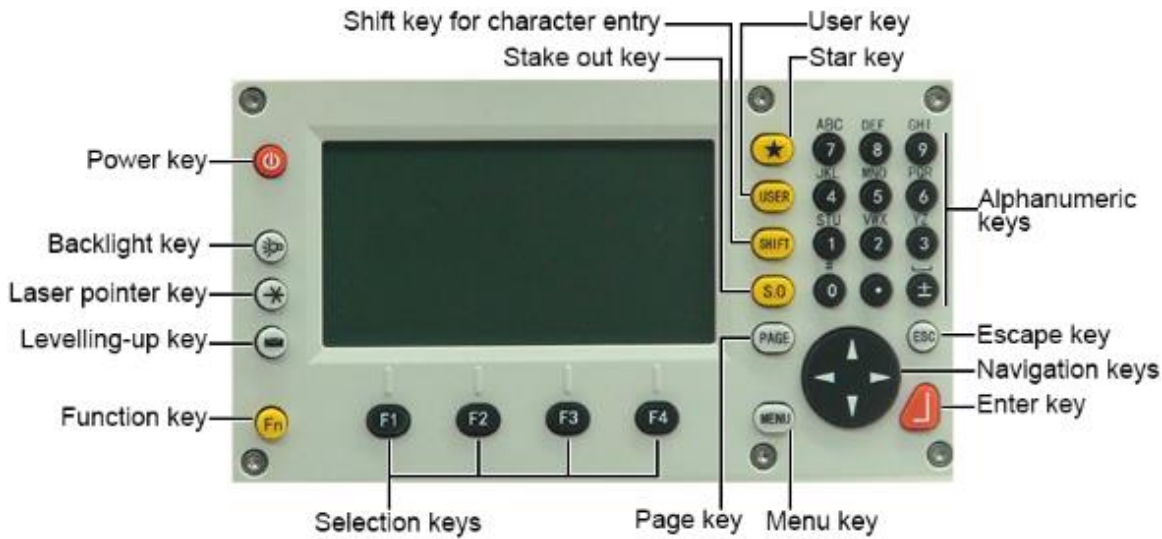

Key	What it does
Power key	To turn on the instrument in no time or turn off the instrument.
Backlight key	To turn on / off the backlight.
Laser pointer key	To turn on / off the laser pointer.
Levelling-up key	To do levelling-up. See 3.3 Do Levelling-up for details.
Function key	To perform sorts of fast function settings defined by program screen.
Selection keys	To select the functions matching the soft keys. About soft keys, see 2.4.1 Soft Keys for details.
Page key	To go to the next page when a display consists of several pages.
Menu key	To access to 9 main menu. See 5 Menu Key for details.
Enter key	To confirm an entry or selection.
Navigation keys	To control the focus bar within the screen and the entry bar within a field.
Escape key	To quit a screen or edit mode without saving changes.
Alphanumeric keys	To directly enter characters (including numbers on keys and letters above keys). See 2.5 Input Mode for details.
Star key	To access star setting mode and do some basic essential settings, including backlight, contrast, reticle illumination, tilt correction, and laser pointer.
User key	It is configurable with function from the Function key.
Shift key for character entry	To shift between number and alphabet when inputting, and to shift target model when measuring.
Stake out key	A shortcut key for staking out.

2.4 Display

E3L is equipped with two large LCD screens (240 * 128dots). And the LCD could display 8 lines with 24 characters per line.



Note: Please do not touch the display with sharp things.

The main display is as follows:

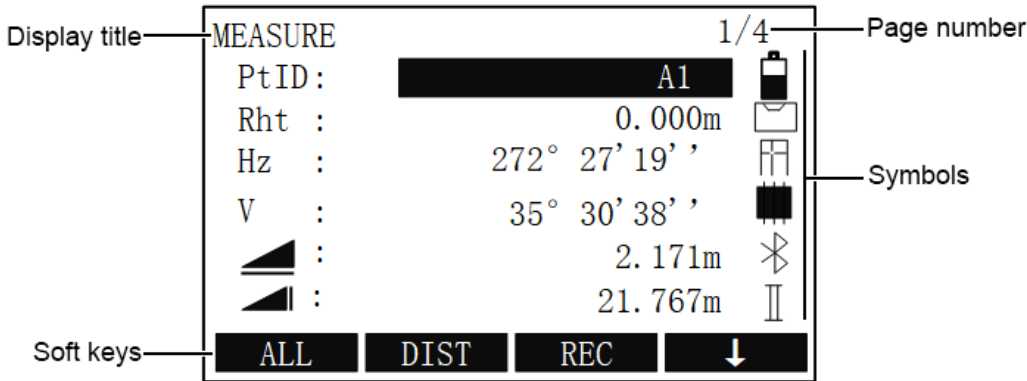

2.4.1 Soft Keys

Under soft keys, a selection of commands and functions are listed at the bottom of the display. You can press **F1 ~ F4** on the operating panel to execute the related command.











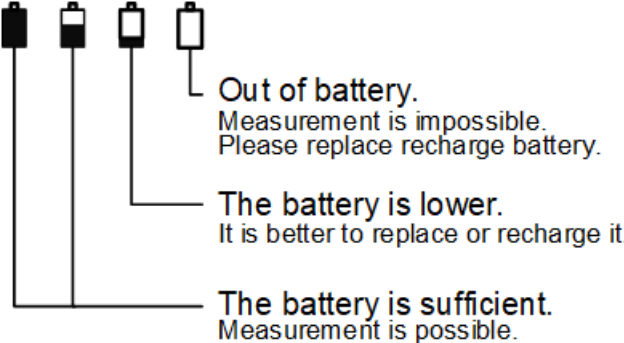

Main soft keys include the following:

Soft key	What it does
ALL	To start distance and angle measurements and save measured values.
DIST	To start distance and angle measurements without saving measured values.
REC	To save the currently displayed values.
ENT	To confirm an entry or selection.
ENH	To open the coordinate input mode.
LIST	To display the list of available points.
FIND	To start the search for the point entered.
EDM	To display EDM settings.
PREV	To return to the last active display.
↓	To go to the next display.
→	To go to the first display.
OK	To set the displayed message or display and quit display.
SHIFT=0	To set the value to zero.
STOP	To stop procedure being carried out.
ALF	Alphabet mode. Its function is equivalent to Shift key.
NUM	Numeric mode. Its function is equivalent to Shift key.

2.4.2 Symbols

Symbols indicate a particular operating status of **E3L**.

Main symbols include the following:

Symbols	What it means
	<p>It indicates the level of the remaining battery capacity.</p>  <p>Out of battery. Measurement is impossible. Please replace recharge battery.</p> <p>The battery is lower. It is better to replace or recharge it.</p> <p>The battery is sufficient. Measurement is possible.</p>
	The compensator is on.
	The compensator is off.
	The prism type is prism.
	The prism type is sheet.
	The prism type is no prism.
	Internal storage mode.
	External storage mode.
	The instrument is connected to the Bluetooth. When the symbol does not show, the instrument is communicated by RS232 serial port.
I / II	When Face I Definition is set to Face_I , I means face left, and II means face right; when it is set to Face_II , I means face right, and II means face left.
	Choice fields (setting the options).
	The vertical distance between the station and the target point.
	The horizontal distance between the station and the target point.
	The slant distance between the station and the target point

2.5 Input Mode

Insert Characters

If a character is skipped (e.g.13 instead of 123), you can insert it later by doing the following:

1. Place the cursor on **1**.
2. To insert an empty character on the right of **1**, press **F1 INSERT**.
3. Input the new character **2**.

Delete Characters

You can delete characters after inputting by doing the following:

1. Place the cursor on the character to be deleted.
2. To delete the character, press **F2 DELET**.

Clear Characters

You can clear characters by doing the following:

1. Place the cursor on any position among character fields.
2. Press **F3 CLEAR**.

Toggle through Characters

You can toggle through characters by doing one of the following:

- To input numbers, directly press the **Alphanumeric** key.
- To input letters, press **Shift / F4 ALF/NUM** and the **Alphanumeric** key.
- To input numbers and letters at the same time, continuously press the **Alphanumeric** key several times.

Example

Press number 7 several times to toggle through 7 → A → B → C → 7 → A...

2.6 Battery

About the battery, please note the following:

- The battery's working time will be affected by many factors, such as ambient temperature, recharging time, recharging and discharging times. Therefore, it is suggested to recharge the battery full or prepare several full batteries before operation.
- The battery symbol only indicates power capability for current measurement mode. The power consumption in distance measurement mode is more than in angle mode, if the instrument enters into distance measurement mode from angle mode, the power maybe auto-off because of lower battery.
- The symbol only indicates the supply power but not the instantaneous power change. And if the measurement mode changes, the symbol will not immediately show the power's decrease or increase.
- It is suggested to check every battery power before field work.

2.6.1 Replace and Mount the Battery

To replace and mount the battery, do the following:

1. Turn the battery lock button to unlock status :



2. Pull the battery lock button out to open the battery cover.
3. Remove the battery by pulling it toward you.
4. Insert the new battery to the instrument.
5. Close the battery cover, and turn the battery lock button to lock status.

2.6.2 Recharge the Battery

New battery or battery that has not used for several months should be recharged for at least 10 hours to attain best status.

The status of the battery charging:

- Red light is always on: in charging.
- Green light is always on: charging is completed.
At this time, please recharge the battery continuously for another 1~2 hours, which is good for the battery.
- Red light flashes: waiting for charging, without a load, poor contact or battery failure

To recharge the battery, do the following:

1. Connect the charger connector to the battery:



2. Plug the charger on 220V AC power supply. The red lamp becomes lighting.
At this time, if the red light flashes, please take off the battery charger and plug it on 220V AC power supply after a while.

3 Quick Start

The process of quick start is as follows:

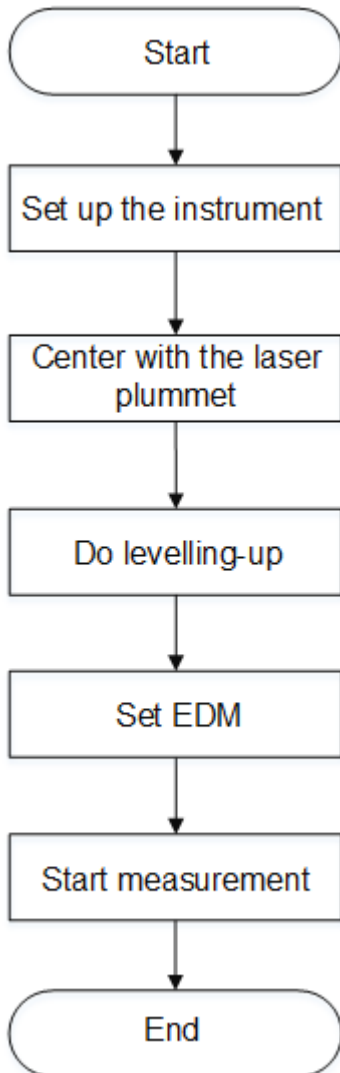

Note: When the instrument is working, it is normal if you hear the noise from instrument motor, it will not affect the instrument work.

3.1 Set up the Instrument

To set up the instrument, do the following:

1. To set up the tripod, do the following:
 - a. Extend the extension legs to suitable lengths.
 - b. Tighten the screws on the legs, and make sure the legs are spaced at equal intervals and the head is approximately level.
 - c. Set the tripod so that the head is positioned over the surveying point.
 - d. Make sure the tripod shoes are firmly fixed in the ground.

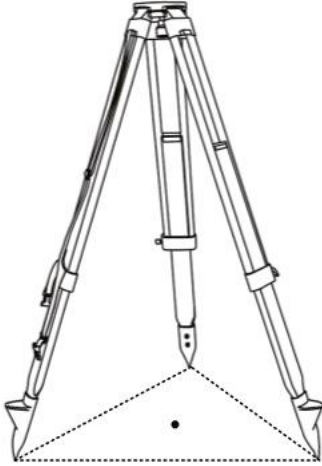

2. To attach the instrument on the tripod head, do the following:
 - a. Carefully mount the instrument on the tripod head.
 - b. Supporting it with one hand, tighten the centering screw on the bottom of the unit to make sure it is secured to the tripod.

3.2 Center with the Laser Plummet

External influences and the surface conditions may lead to the requirement of the adjustment of the laser intensity. The laser can be adjusted in 25% steps as required. If the instrument is equipped with laser plummet, after activating electronic level, the laser plummet adjusting bar will display.

To center with laser plummet, do the following:

1. To enter **LEVEL/PLUMMET** display, press **Fn**, and press **F1 / 1**.

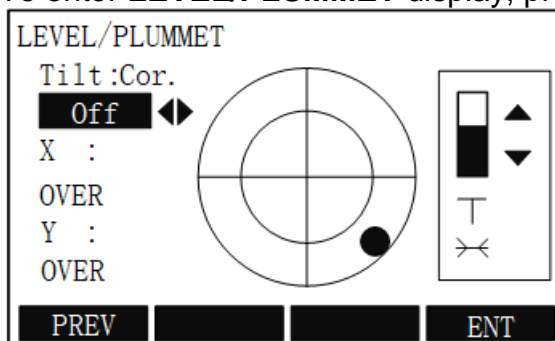

2. To turn on / off the laser plummet, press ◀ / ▶.

- Optional:** To adjust the lightness of the laser plummet, press ▲ / ▼.



- Loosen the center screw of the tripod, move the base plate on the tripod head until the laser spot coincides with the mark point on ground, and tighten the center screw.

3.3 Do Levelling-up

3.3.1 Do Basic Levelling-up

It is used to do basic levelling-up with the circular level.

To do basic levelling-up with the circular level, do the following:

- Move screws A and B in the opposite direction until the circular bubble is perpendicular to a line shaped with screw A and B.

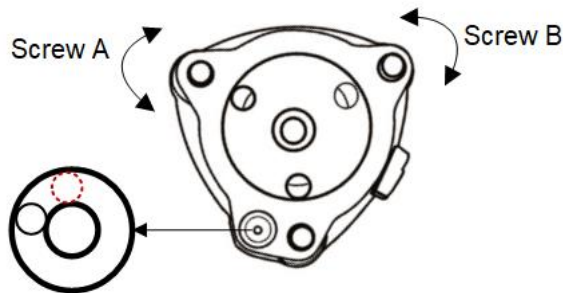

The direction of your left thumb indicates the movement of the circular bubble.

- Move the bubble to the center of the circle by turning screw C.

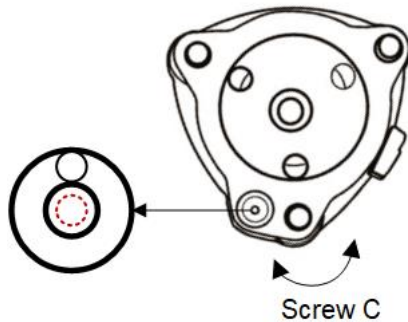

3.3.2 Do Accurate Levelling-up

To do accurate levelling-up, do one of the following:

- [Do Accurate Levelling-up with the Tubular Level](#)
- [Do Accurate Levelling-up with the Electronic Level on the Screen](#)

3.3.2.1 Do Accurate Levelling-up with the Tubular Level

To do accurate levelling-up with the tubular level, do the following:

1. Loosen the horizontal motion clamp, turn the instrument till the tubular level is parallel to a line shaped with screws A and B, and adjust the screws A and B to make the bubble in the center of the level.

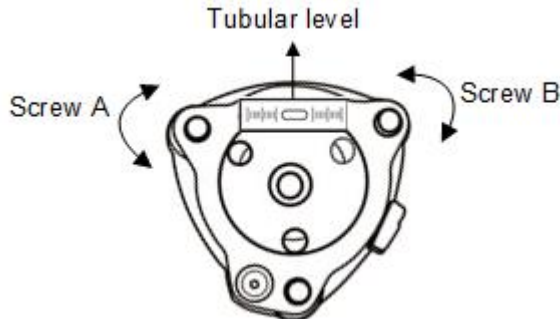

2. Loosen the horizontal motion clamp, turn the instrument approximately 90°, and adjust the screw C until the bubble in the center of the level.

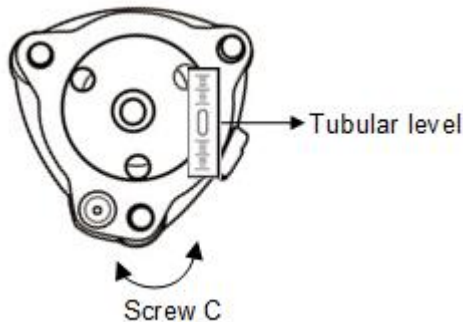

3. Repeat above steps until the bubble remains in the center of the tubular level while the instrument is rotated to any position.

3.3.2.2 Do Accurate Levelling-up with the Electronic Level on the Screen

It is convenient for RTS330 series to level-up with electronic level, especially when it is difficult to observe the circular level and tubular level.

To do accurate levelling-up with the electronic level on the screen, do the following:

1. Power on the instrument.
2. To enter **LEVEL/PLUMMET** display, press **Fn**, and press **F1 / 1**.

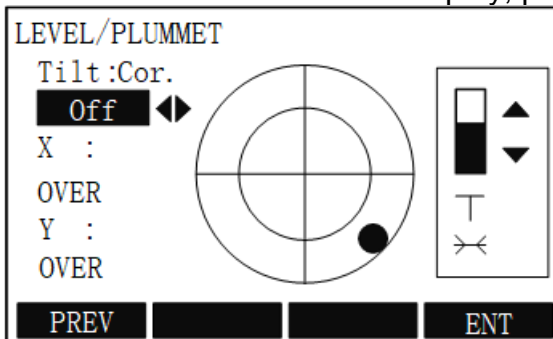

3. **Optional:** To turn on/off the X/Y compensator by pressing ◀ / ▶.
4. Do accurate levelling-up by turning three foot screws, and make sure the bubble is in the tubular level and the black spot is in the center on the screen.

3.4 Set EDM

See [5.4 EDM Menu](#) for details.

3.5 Start Measurement

After switching on and setting up correctly, **E3L** is immediately ready for measurement.

See [5.2.1 Surveying](#) for details.

4 Function Key

Under **Function** key, the following functions can be activated:

- Level / Plummet
- Target Offset
- Target Set
- Delete Last Record
- Height Transfer
- Hidden Point
- Free-Coding
- Laser Pointer
- Check Tie
- Main Settings
- Tracking
- Light On/Off
- Units

Each function from the function key can be assigned to **USER** key.

4.1 Level / Plummet

It is used to trigger the electronic bubble and enable the settings of intensity for the laser plummet.

See [3.2 Center with the Laser Plummet](#) for details.

4.2 Target Offset

It is used to set offset values (including length, cross, and height offset), if it is not possible to directly set up the prism or to directly aim at the target point. As a result, the values for the angle and distances can be directly calculated for the target point.

The principle is as follows:

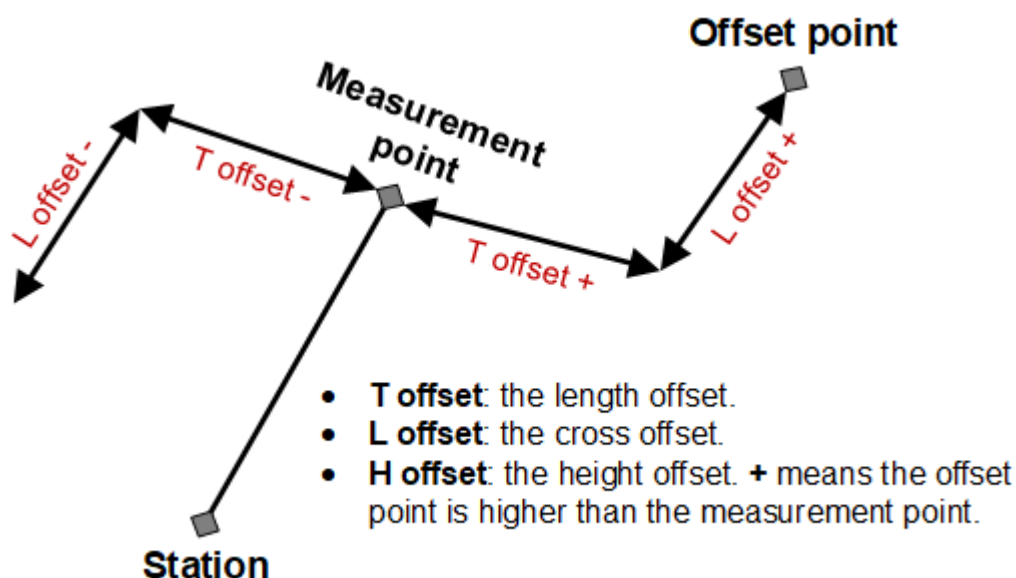

To set offset values, do the following:

1. To select **Target Offset**, press **Fn**, and press **F2** / **2. TARGET OFFSET** display shows:

TARGET OFFSET	
Input offset value!	
T_OFFSET:	0. 600m
L_OFFSET:	0. 700m
H_Offset:	0. 800m
Mode:	Forever ◀▶
RESET	ENT

2. Input the offset values (T offset, L offset and H offset) according to the principle.
3. Define the period during which the offset is to apply:
 - **Reset**: the offset values are reset to 0 after the point is saved.
 - **Forever**: the offset values are applied to all further measurements.
4. To reset offset values to zero, press **F1 RESET**.
5. To calculate the corrected values, press **F4 ENT**. The display jumps to the application from which the offset function is started.
The corrected angle and distance are displayed once a valid distance measurement has been triggered.

4.3 Target Set

It is used to switch among the following prism types:

- Prism: distance measurements with prisms.
- Sheet: distance measurements with sheets.
- No prism: distance measurements without prisms.

To switch among prism types, do the following:

1. To select **Target Set**, press **Fn**, and press **F3** / **3. TARGET TYPE** display shows:

TARGET TYPE			
<input type="radio"/>	F1	PRISM	
<input checked="" type="radio"/>	F2	Sheet	
<input type="radio"/>	F3	NoPrism	
F1	F2	F3	PREV

2. To select a prism type, press **F1**, **F2** or **F3**.
3. To return to the previous page and simultaneously save setting, press **F4 PREV**.

4.4 Delete Last Record

It is used to delete the last recorded measurement block or code block.

Only records generated during surveying and measuring can be deleted.



Note: This operation is not reversible.

To delete the last record, do the following:

1. To select **Delete Last Record**, press **Fn**, and press **F4 / 4**. The following display shows:

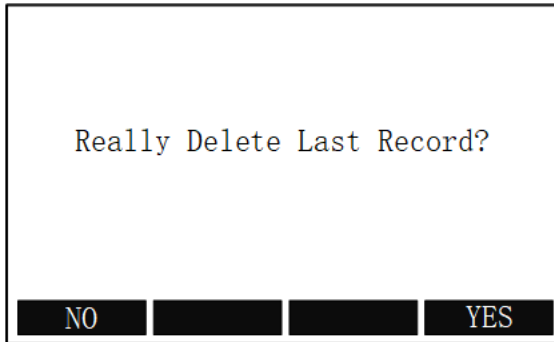

2. Press **F4 YES**.

4.5 Height Transfer

It is used to determine the height of the instrument by measurements five known points at most in two faces.

The principle is as follows:

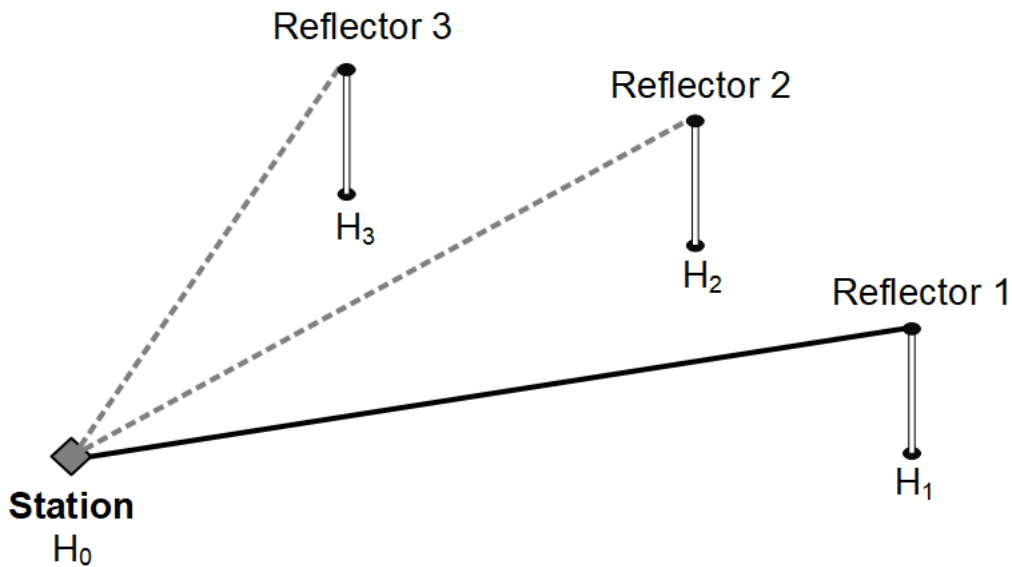

To determine the height of the instrument, do the following:

1. To select **Height Transfer**, press **Fn** and **PAGE** to go to the second page, and press **F1 / 5**. **HEIGHT TRANSFER** display shows:

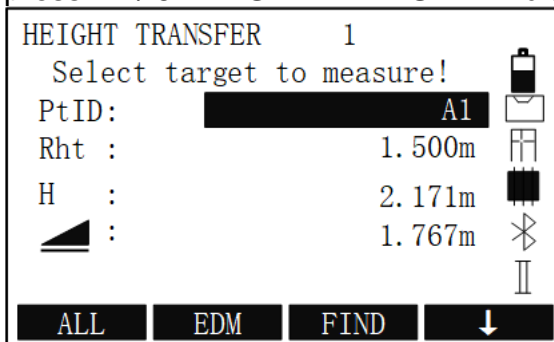

2. Select a known point and input the reflector height.
3. To trigger the measurement, press **F1 ALL**. The calculated height **H0** is displayed:

HEIGHT TRANSFER RESULT	1/2
Station:	DEFAULT
H0:	-0.260m
Residual:	0.000m
PtsNum:	01
ADDP	FACEII
PREV	ENT

HEIGHT TRANSFER RESULT	2/2
Station:	DEFAULT
X0/N0:	45.000m
Y0/E0:	25.000m
H0:	-0.260m
PtsNum:	01
DEVS:	0.000m
ADDP	FACEII
PREV	ENT

4. To add another height of a known point, press **F1 ADDP**.
5. To trigger the measurement, press **F1 ALL**.
6. **Optional:** To measure the same target in the second face, press **F2 FACEII**.
7. To save the changes and set the station, press **F4 ENT**.

4.6 Hidden Point

It is used to measure a point that is not directly visible, using a special hidden point rod.

The principle is as follows:

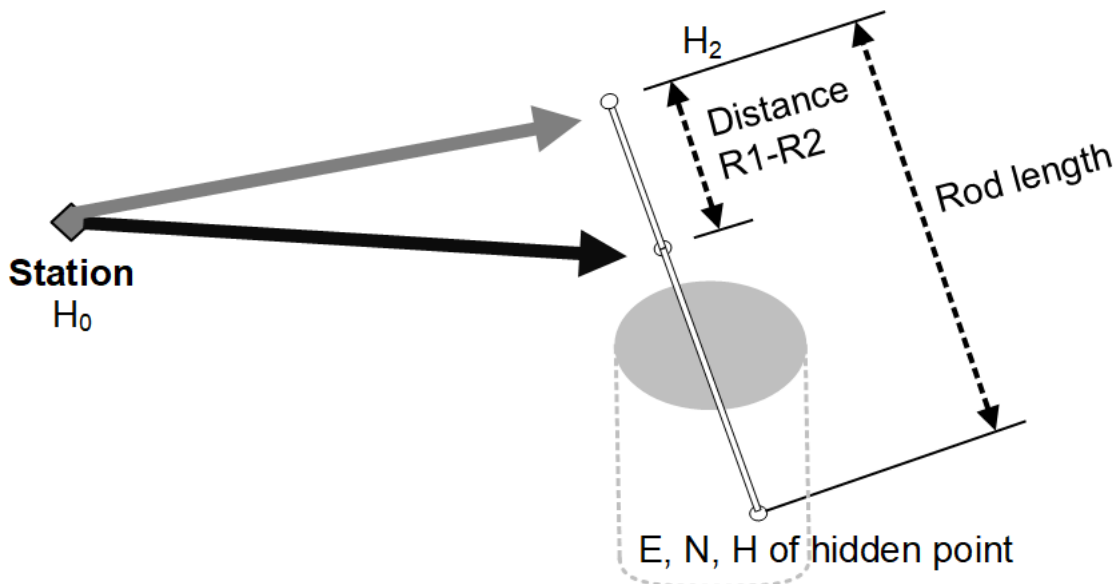

To measure a hidden point, do the following:







1. To select **Hidden Point**, press **Fn** and **PAGE** key to switch to the second page, and press **F2 / 6. HIDDEN POINT** display shows:

HIDDEN POINT		
Measure first prism!		
PtID:	A1	
H _z :	270° 27' 19''	
V :	35° 30' 38''	
:	2.171m	
ALL	DIST	REC
		ROD/ED

2. **Optional:** To define the rod and EDM settings, press **F4 ROD/ED. ROD LENTHT SET** display shows:

ROD LENGTH SET	
EDM Mode:	Fine ◀▶
Prism Type:	NoPrism ◀▶
Prism Const:	0.0m
Rod Length:	3.000m
Dist. R1-R2:	1.000m
Meas. Tol:	0.100m
ENT	

- **EDM Mode:** to change the EDM Mode. See [5.4 EDM Menu](#) for details.
 - **Prism Type:** to change the prism type. See [5.4 EDM Menu](#) for details.
 - **Prism Const:** to show the prism constant.
 - **Rod Length:** to set the total length of hidden point rod.
 - **Dist. R1-R2:** to set the space between the centers of reflector R1 and prism R2.
 - **Meas.Tol:** to limit the difference between the given space and the measured space of the reflectors. If the tolerance value is exceeded, a warning occurs.
3. To measure the first prism, in **HIDDEN POINT** display, press **F1 ALL**. The data is automatically saved, and the following display shows:

HIDDEN POINT			
Measure second prism!			
PtID:	A2 		
Hz :	122° 23' 33" ' 		
V :	53° 09' 25" ' 		
 :	3.086m 		
			
ALL	DIST	REC	PREV

4. To measure the second prism, press **F1 ALL**. The data is automatically saved and the following display shows:

- The range is not exceeded:

HIDDEN POINT RESULT	
PtID:	A16
Desc. :	-----
North:	2.136m
East:	3.206m
Height:	5.010m
NEW	NEWP

At this time, press **F1 ACCEPT** to finish measuring a hidden point.

- The range is exceeded:

Range exceeded!	
Pre. LIM:	0.100m
TOL :	0.625m
ACCEPT	NEW

At this time, press **F4 NEW**, and repeat step 2 ~ 4 to measure a hidden point again.

4.7 Free-Coding

It is used to select a code from the code list or input a new code.

To start free-coding, do the following:

1. To select **Free-Coding** and enter **CODE (FIND/SELECT)** display, press **Fn** and do one of the following:
 - Press **PAGE** → **F3**
 - Press **7**.

CODE (FIND/SELECT)	
Select or input new code!	
Search:	-----
Code:	1 ◀▶
Q-Code:	-----
Desc:	-----
Info1:	-----
REC	ADD ENT

2. Select a code from the code list.
3. If the input code does not in the code list and you would like to add a new code, input related information and press **F2 ADD**, and input data.
4. Press **F4 ENT** for confirmation.

4.8 Laser Pointer

It is used to turn on or off the visible laser beam for illuminating the target point.

To turn on / off the laser pointer, press **Fn** and do one of the following:

- Press **PAGE** to go to the second page, and press **F4**.
- Press **8**.

The display shows *Laser Switched On / Laser Switched Off* for approximately 1s.

4.9 Check Tie

It is used to calculate and check the slope distance, horizontal distance, height difference, azimuth, grade, and coordinate differences between the last two measured points.

The principle is as follows:

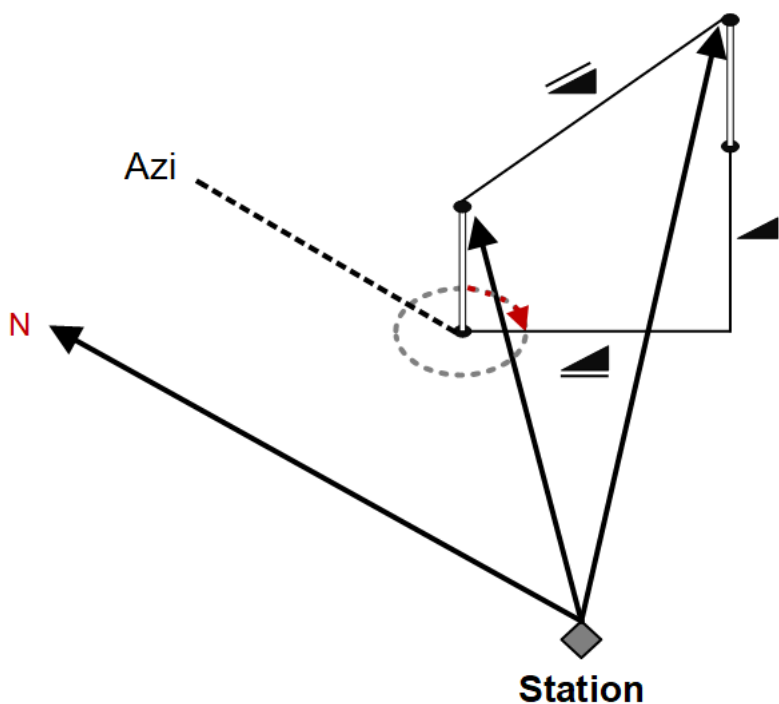

Before checking the tie, make sure at least a distance measurement has been done and two valid measured points exist.

To check the tie, do the following:

1. To enter **CHECK Tie** display, press **Fn**, and press **PAGE** to go to the third page, and press **F1 / 9**.

CHECK TIE	1/2
Brg:	122° 23' 33" '
Gradient:	3%
dHD:	0.468m
dSD:	0.469m
dVD:	0.015m
ENT	

CHECK TIE	2/2
Brg:	150° 34' 00" '
Gradient:	0%
dX/N:	-0.068m
dY/E:	0.039m
dH:	-0.000m
ENT	

2. After checking all values, press **F4 ENT** for confirmation.

4.10 Main Settings

Its function is totally same with the **SETS** menu page.

See [5.3 Setting Menu](#) for details.

4.11 Tracking

It is used to enable / disable the tracking measurement mode. And it can only be activated from within the same EDM mode and prism type.



Note: The last setting remains valid when the instrument is powered off.

To select **Tracking** and enable / disable the tracking measurement mode, press **Fn** and do one of the following:

- Press **PAGE** to go to the third page, and press **F3**.
- Press **02**.

The display shows *Take Measure Switched On / Take Measure Switched Off* for approximately 1s.

4.12 Light On/Off

It is used to turn on or off the display illumination.

To turn on / off the light, press **Fn** and do one of the following:

- Press **PAGE** to go to the third page, and press **F4**.
- Press **0** and **3**.

The display illumination is automatically on / off.

4.13 Units

It is used to display the current distance and angle units and give the possibility to change them by ◀ / ▶.

To set the units of distance and angle, do the following:

1. To enter the setting display, press **Fn**, and press **PAGE** to go to the fourth page:

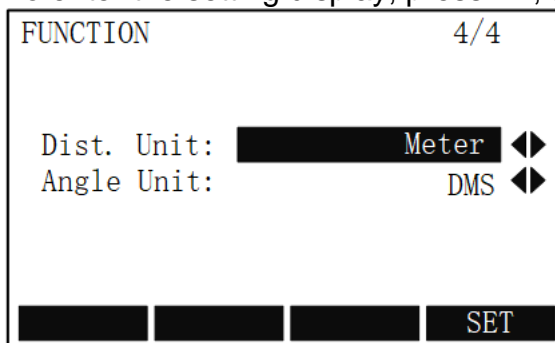

2. Set the distance unit and angle unit.
About the supported units, see [5.3 Setting Menu](#) for details.
3. Press **F4 SET** for conformation.

5 Menu Key

5.1 Overview

With **MENU** key, you enter the following menu pages:

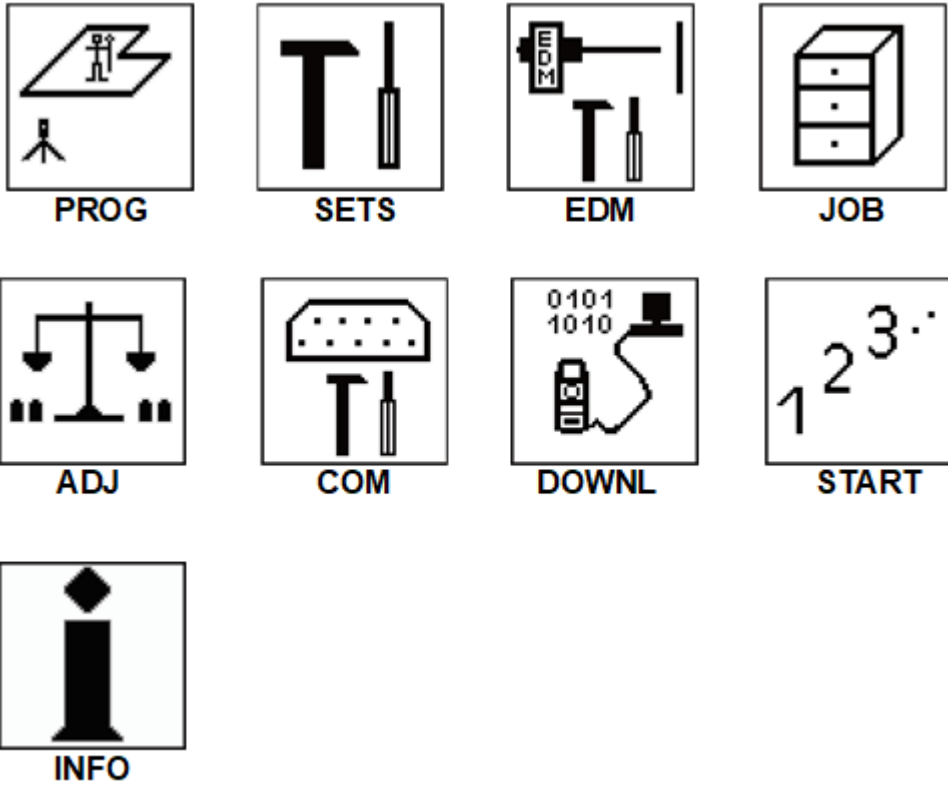

You can enter menu pages by press **MENU**:

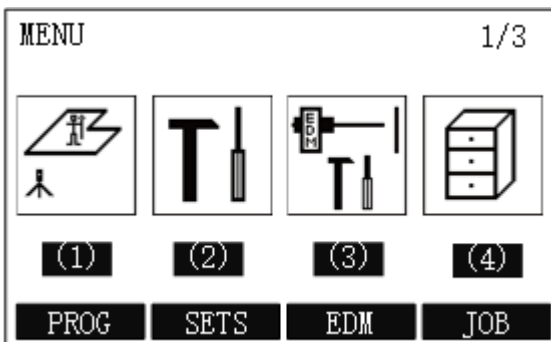

5.2 Program Menu

This menu contains programs that precede the application programs, and is used to set up and organize data collection.

With this menu, you can achieve the following:

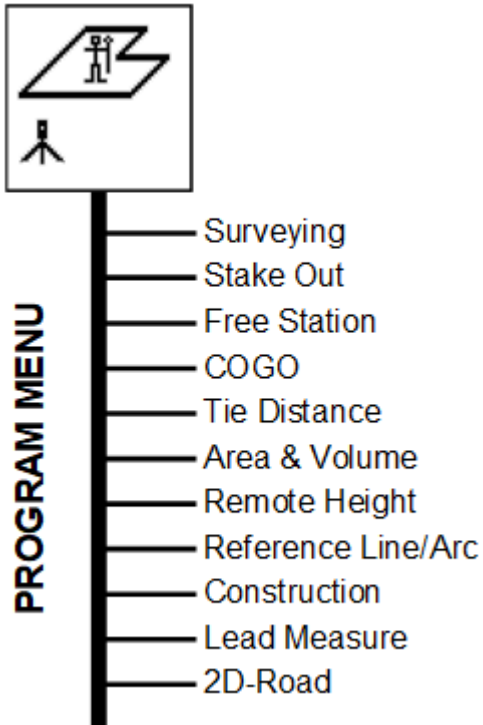

You can enter all programs by pressing **MENU** and **F1 PROG / 1**:

PROGRAMS	1/3
F1 Surveying	(1)
F2 Stake Out	(2)
F3 Free Station	(3)
F4 COGO	(4)
F1	F2
F3	F4

5.2.1 Surveying

To set surveying, do the following:

1. To enter **Program** menu page, press **MENU** and press **F1/ 1**.
2. Press **F1** or **1**:

MEASURE SET			
[◆]	F1 Set Job	(1)	
[]	F2 Set Station	(2)	
[]	F3 Set Orientation	(3)	
	F4 Start	(4)	
F1	F2	F3	F4

- [◆]: it indicates that settings are done.
 - []: it indicates that settings are not done.
3. Do the following:
 - a. [Set a Job](#)
 - b. [Set the Station](#)
 - c. [Set the Orientation](#)
 - d. [Start Survey](#)

5.2.1.1 Set a Job

All data is saved in jobs like directories, which contain measurement data of different types, including fixed points, measurements, codes, stations, etc., and can be individually manageable and readout, edited or deleted. Thus, setting a job to save all recorded data is required before your work.



Note: If no job is defined before an application is started or if **ALL** soft key (i.e. **F1** key in **MEASURE** display) is triggered, the system will automatically create a new job and name it **DEFAULT**.

To set a job, do the following:

1. To enter **NEW JOB** display and create a new job, in **MEASURE SET** display, press **F1 / 1** → **F1 ADD**:

NEW JOB	
Job :	[REDACTED] _____
Operator :	_____
Note 1 :	_____
Note 2 :	_____
PREV	ENT

2. Set the name of the job, record the operator, and make notes.
3. To save the job, press **F4 ENT**. The display automatically returns to **SET JOB** display.
4. Press **F4** for confirmation. The display shows *Job Set*.

5.2.1.2 Set the Station

It is used to set the coordinates of the station.

To set the station, do the following:

1. To enter **SET STATION** display, in **MEASURE SET** display, press **F2 / 2**:

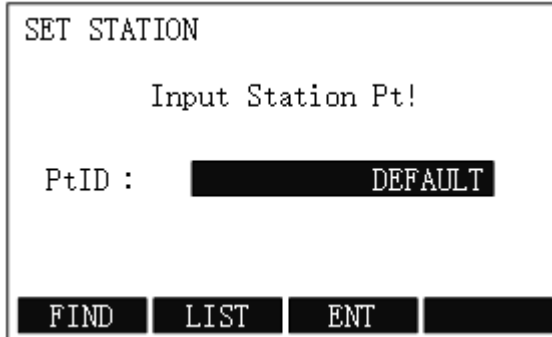

2. Do one of the following:
 - Manually set the station:
 - i. To open **COORDINATE INPUT** display, press **F3 ENT**.
 - ii. Set the point ID and coordinates.
 - iii. To save station coordinates, press **F4 ENT**. The display automatically returns to **SET STATION** display.
 - iv. Set the height of the instrument after input box **Hi**.
 - v. Press **F4 ENT**. The display shows *Data Saved*.
 - Set the station by reading from the internal memory:
 - i. To select a Point ID stored in the internal memory, press **F1 FIND / F2 LIST**.
 - ii. Select a point, and press enter key.
 - iii. Set the height of the instrument after input box **Hi**.
 - iv. Press **F4 ENT**. The display shows *Data Saved*.

5.2.1.3 Set the Orientation

It is used to set the horizontal direction with the orientation.

To set the orientation, do one of the following:

1. To enter **ORIENTATION** display, in **MEASURE SET** display, press **F3 / 3**

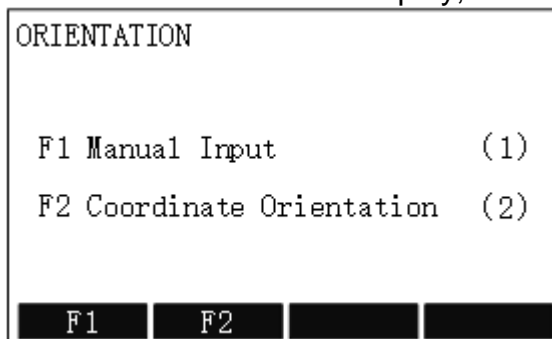

2. Do one of the following:
 - Manually set the orientation:
 - i. To enter **MANUAL INPUT** display, press **F1 / 1**.
 - ii. Set backsight point, reflector height and Hz-direction (Azimuth).
 - iii. Press **F1 ALL** to trigger measurement. The display shows *Data Saved and Orientated*.
 - Set the orientation with coordinates:
 - i. To enter **COORDINATE ORIENTATION** display, press **F2 / 2**.
 - ii. Do one of the following:
 - Press **F1 LIST**, and select a point stored in the internal memory.
 - Press **F2 ENH**, set the backsight point and coordinates of north, east and H, and press **F4 ENT**.
 - iii. Set the reflector height.
 - iv. Press **F1 ALL** to trigger measurement. The display shows *Data Saved and Orientated*.

5.2.1.4 Start Survey

It is used to start surveying with an unlimited number of points.

The principle is as follows:

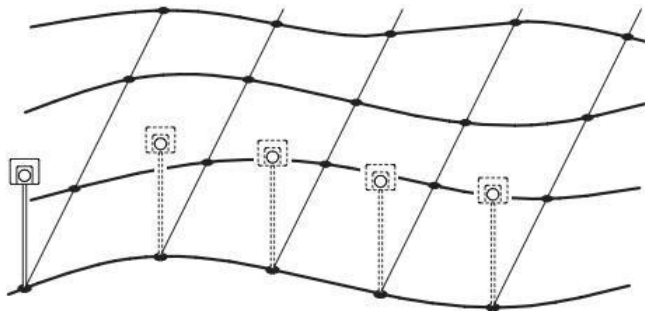

To start survey, do the following:

1. To enter **MEASURE** display, in **MEASURE SET** display, press **F4 / 4**:

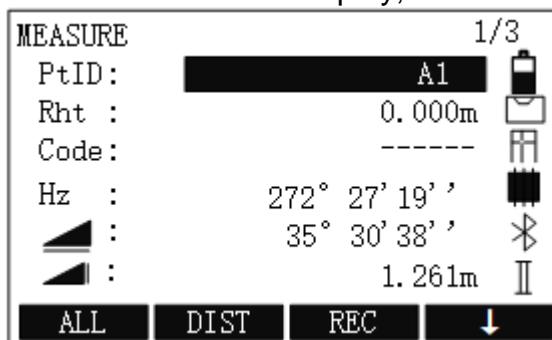

2. Set the point ID, reflector height.

3. **Optional:** To set the code, and do one of the following:
 - To directly input a code, input a code into the input box of **Code**. The code is stored along with the corresponding measurement.
 - To search the code from the codelist, press ↓ → **F2 CODE**. It gives the possibility to add attributes to the code.
 - Press ↓ twice → **F2 Q_CODE** and enter the shortcut to the code.
4. **Optional:** To switch between the individual and current point number, press ↓ three times → **F2 IndivPt**.
5. Press **F1 ALL** to trigger measurements.

5.2.2 Stake out

This program is used to calculate the required elements of staking out, based on the coordinates, manually input angles, horizontal distances and heights of staking out points.

To set staking out, do the following:

1. To enter **STAKE OUT** display, do one of the following:
 - Press **S.O.**
 - Press **MENU** and press **F1 PROG / 1** to enter **Program** menu page, and press **F2 / 2**:

STAKE OUT	
[◆] F1 Set Job	(1)
[] F2 Set Station	(2)
[] F3 Set Orientation	(3)
F4 Start	(4)
F1	F2
F3	F4

- [◆]: it indicates that settings are done.
 - []: it indicates that settings are not done.
2. Do the following:
 - a. Set a Job
 - b. Set the Station
 - c. Set the Orientation
 - d. Start Staking out

5.2.2.1 Set a Job

See [5.2.1.1 Set a Job](#) for details.

5.2.2.2 Set the Station

See [5.2.1.2 Set the Station](#) for details.

5.2.2.3 Set the Orientation

See [5.2.1.3 Set the Orientation](#) for details.

5.2.2.4 Start Staking out

To start staking out, do the following:

1. In **STAKE OUT** display, press **F4 / 4**:

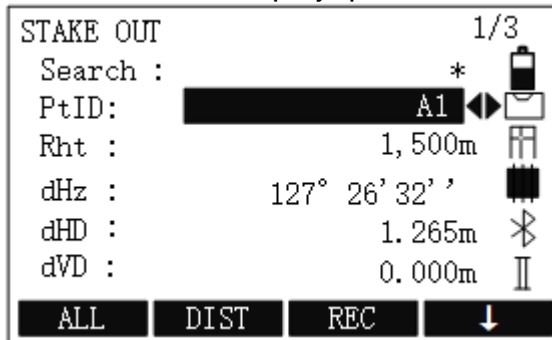

2. Do one of the following:
 - To start measuring and calculation of the stake-out elements, select the target point, and press **F2 DIST**.
 - To input direction and Hz-distance of the point to stake out, press ↓ twice and **F1 B&D**.
 - To enable simplified input of a point without point ID and the possibility of storing the data of the point, press ↓ twice and **F2 Manual**.
3. To save the displayed values, press **F3 REC**.
4. Press **F1 ALL** to trigger measurements.

The result of staking out is as follows (there are three displays of the result, and you can switch the display by pressing **PAGE**):

- **Polar Stake out**

STAKE OUT		1/3
Search :	*	
PtID:	A1	
Rht :	1,500m	
dHz :	127° 26' 32' '	
dHD :	1.265m	
dVD :	0.000m	
ALL		DIST
REC		↓

The principle is as follows:

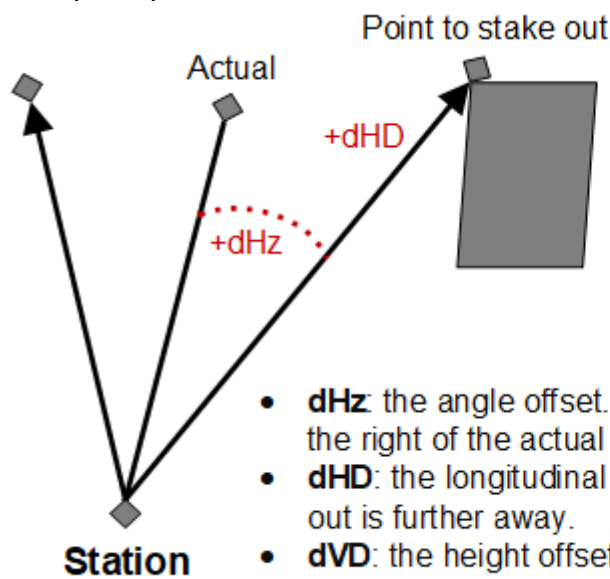

- **dHz**: the angle offset. + means the point to stake out is in the right of the actual direction.
- **dHD**: the longitudinal offset. + means the point to stake out is further away.
- **dVD**: the height offset. + means the point to stake out is higher than the measured point.

- **Orthogonal Stake out**

STAKE OUT		2/3
Search :	*	
PtID:	A1	
Rht :	1,500m	
d Line:	-1.299m	
d Off:	0.000m	
dH:	-2.976m	
ALL		DIST
REC		↓

The principle is as follows:

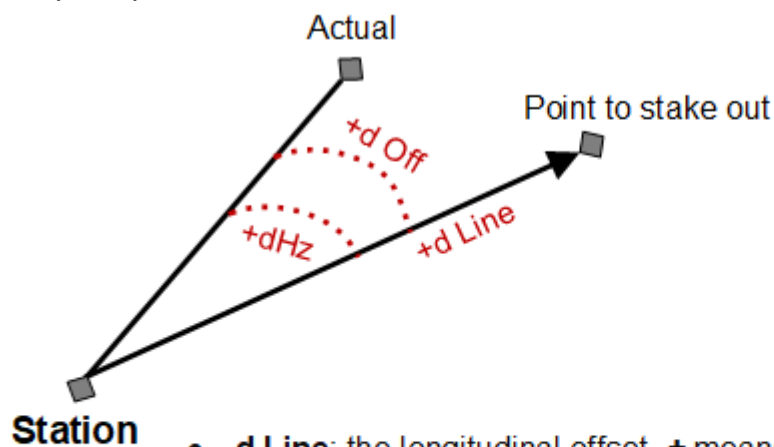

- **d Line:** the longitudinal offset. + means the point to stake out is further away.
- **d Off:** the transversal offset, perpendicular to line-of-sight. + means the point to stake out is in the right of the measurement point.

- Cartesian Stake out

STAKE OUT		3/3
Search :	*	
PtID:	A1	
Rht :	1,500m	
dX/N:	0.768m	
dY/E:	1.047m	
dH:	-2.976m	
ALL		DIST
REC		↓

The principle is as follows:

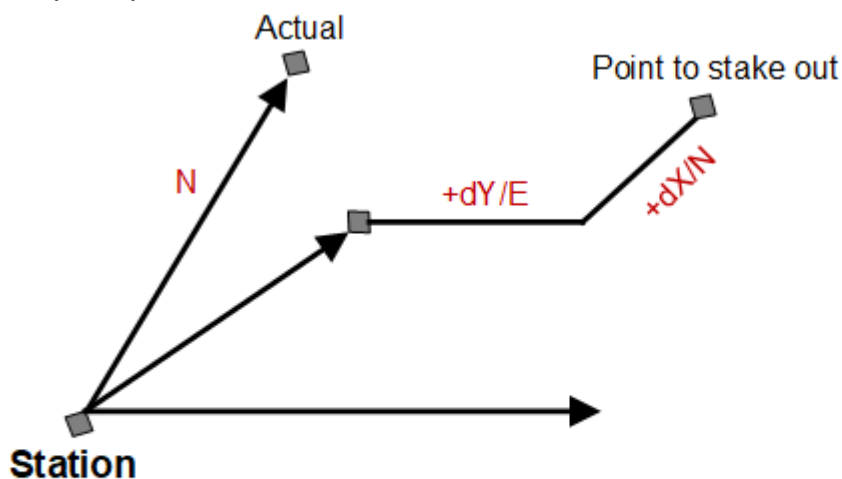

- **dX/N**: the northing offset between the actual point and the point to stake out.
- **dY/E**: the easting offset between the actual point and the point to stake out.

5.2.3 Free Station

This program is used to determine the instrument position from measurements of 2 ~ 5 known points.

The principle is as follows:

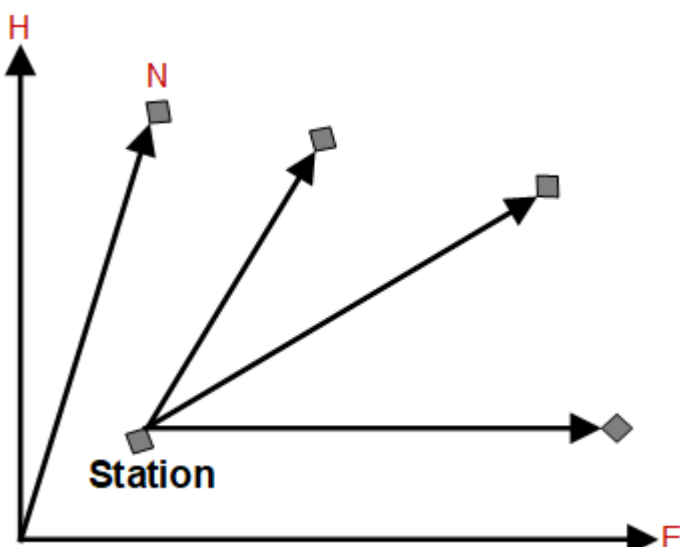

To set free station, do the following:

1. To enter **Program** menu page, press **MENU** and **F1 PROG / 1**.
2. Press **F3 / 3**:

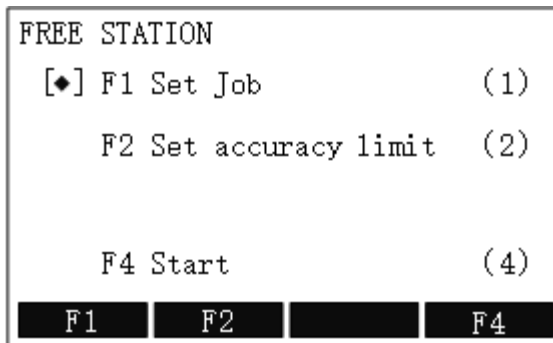

- [◆]: it indicates that settings are done.
 - []: it indicates that settings are not done.
3. Do the following:
 - a. [Set a Job](#)
If you have done it in before, you can skip it.
 - b. [Set Accuracy Limit](#)
 - c. [Start Free Station](#)

5.2.3.1 Set a Job

See 5.2.1.1 [Set a Job](#) for details.

5.2.3.2 Set Accuracy Limit

It is used to define a limit for the standard deviation values. If the calculated deviation exceeds the limit, a warning dialog box pops to remind you whether to proceed or not.

To set accuracy limit, do the following:

1. To enter **ACCURACY SETTING** display, in **FREE STATION** display, press **F2 / 2**:

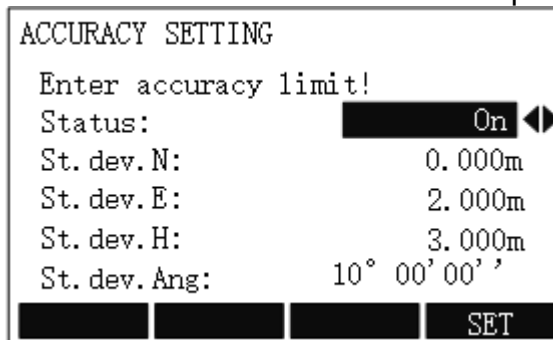

2. Set deviations of north, east and height.
3. Press **F4 SET** for confirmation. The display returns to **FREE STATION** display.

5.2.3.3 Start Free Station

To start free station, do the following:

1. To enter **FREE STATION-STATION** display, in **FREE STATION** display, press **F4 / 4**:

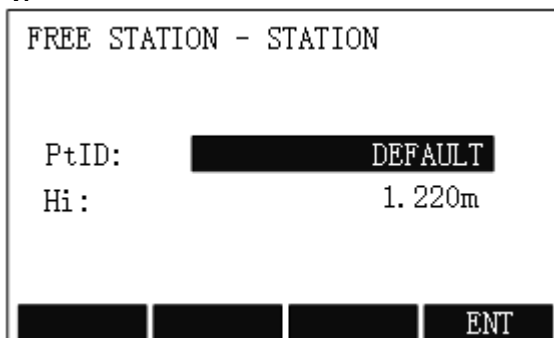

```

FREE STATION - STATION

PtID: [redacted] DEFAULT
Hi: 1.220m

[redacted] [redacted] [redacted] ENT
    
```

2. Input of the name of the station and the height of the instrument, and press **F4 ENT** for confirmation:

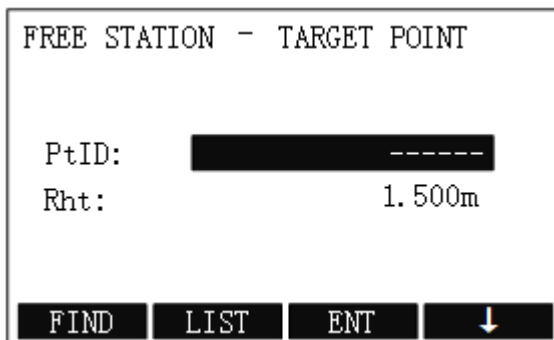

```

FREE STATION - TARGET POINT

PtID: [redacted] -----
Rht: 1.500m

FIND LIST ENT ↓
    
```

3. Do one of the following, and press **F3 ENT** for confirmation:
 - To find a known point, press **F1 FIND / F2 LIST**.
 - To directly input ID of the target point and the height of the reflector or press **↓ → F1 ENH**.

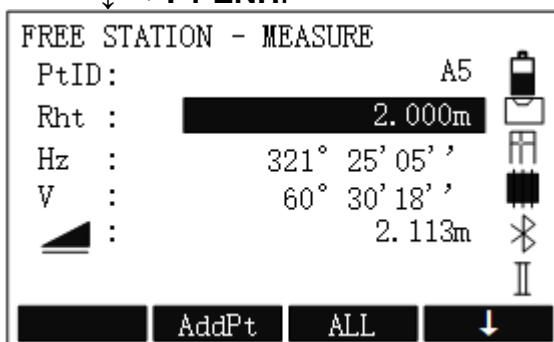

```

FREE STATION - MEASURE

PtID: A5
Rht : [redacted] 2.000m
Hz  : 321° 25' 05''
V   : 60° 30' 18''
▲   : 2.113m

[redacted] AddPt ALL ↓
    
```

4. Press **F3 ALL** to trigger angle and distance measurements. The display shows *Data Saved*.

5. To add another point, do the following:
 - a. Press **F2 AddPt.**
 - b. Do one of the following, and press **F3 ENT** for confirmation:
 - To find a known point, press **F1 FIND / F2 LIST.**
 - To directly input ID of the target point and the height of the reflector or press $\downarrow \rightarrow$ **F1 ENH.**
 - c. Press **F3 ALL** to trigger angle and distance measurements.

Dist Check	
Act. HD:	0.000m
Meas. HD	0.000m
dHD:	0.001m
Continue?	
PREV	ENT

6. Press **F4 ENT** for confirmation.
If you need to start measurement again, press **F1 PREV.**
7. **Optional:** To add more points, repeat step 1 ~ 6.
8. Press **F1 COMPUTE.** The result is as follows:

STATION COORDINATE			
Station:	A1		
Hi:	1.200m		
North:	1.000m		
East:	1.891m		
Height:	3.359m		
PREV	RESID	STDEV	ENT

9. Press **F4 ENT** for confirmation. The display shows *Data Saved* and *Station Settled*.

5.2.4 COGO

To set COGO, do the following:

1. To enter **Program** menu page, press **MENU** and **F1 PROG / 1.**
2. Press **F4** or **4:**

COGO			
[◆] F1 Set Job	(1)		
[] F2 Set Station	(2)		
[] F3 Set Orientation	(3)		
F4 Start	(4)		
F1	F2	F3	F4

- [◆]: it indicates that settings are done.
- []: it indicates that settings are not done.

3. Do the following:
 - a. [Set a Job](#)
If you have done it before, you can skip it.
 - b. [Set the Station](#)
If you have done it before, you can skip it.
 - c. [Set the Orientation](#)
If you have done it before, you can skip it.
 - d. [Start COGO](#)

5.2.4.1 Set a Job

See [5.2.1.1 Set a Job](#) for details.

5.2.4.2 Set the Station

See [5.2.1.2 Set the Station](#) for details.

5.2.4.3 Set the Orientation

See [5.2.1.3 Set the Orientation](#) for details.

5.2.4.4 Start COGO

To start COGO, do the following:

1. In **COGO** display, press **F4 / 4**:

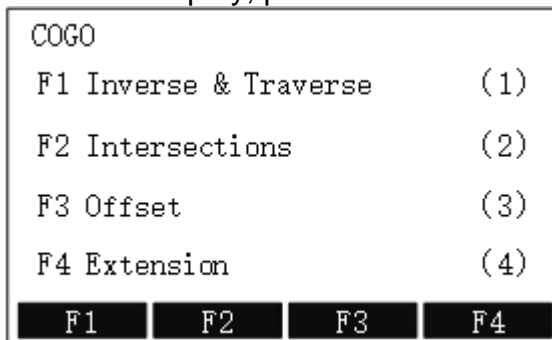

2. Do the following:
 - a. [Set Inverse or Traverse Computation](#)
 - b. [Set Intersections](#)
 - c. [Set Offset](#)
 - d. [Set Extension](#)

5.2.4.4.1 Set Inverse or Traverse Computation

To set inverse or traverse computation, do one of the following:

- [Set Inverse Computation](#)
- [Set Traverse Computation](#)

5.2.4.4.1.1 Set Inverse Computation

The principle of inverse computation is as follows:

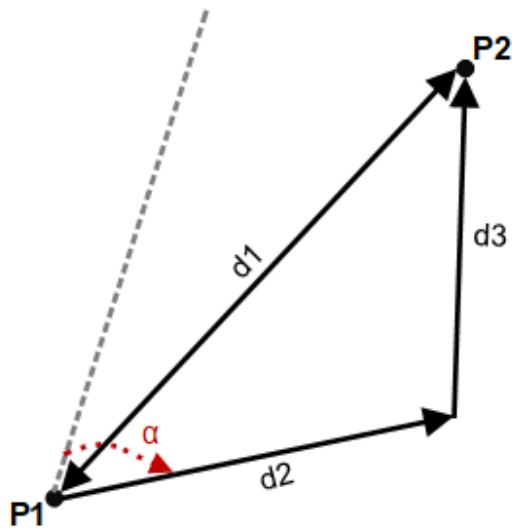

Known data

- P1: the 1st known point.
- P2: the 2nd known point.

Unknown data

- d1: the slant distance between P1 and P2.
- d2: the horizontal distance between P1 and P2.
- d3: the height between P1 and P2.

To set inverse computation, do the following:

1. To select **Inverse**, press **F1 / 1** in **COGO** display, and press **F1 / 1**.

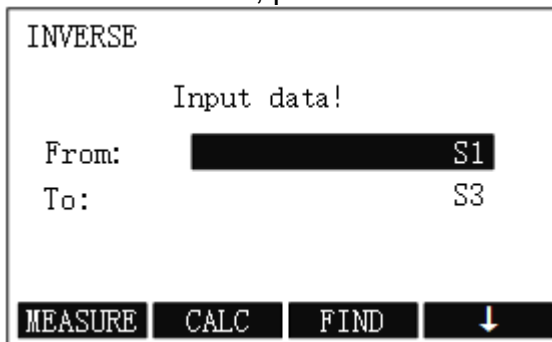

2. Input data and press **F2 CALC** for computing. **INVERSE RESULT** display shows:

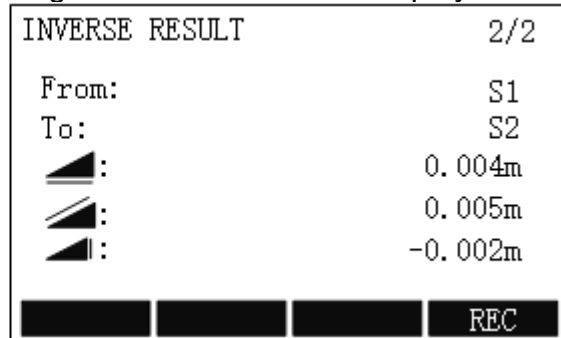
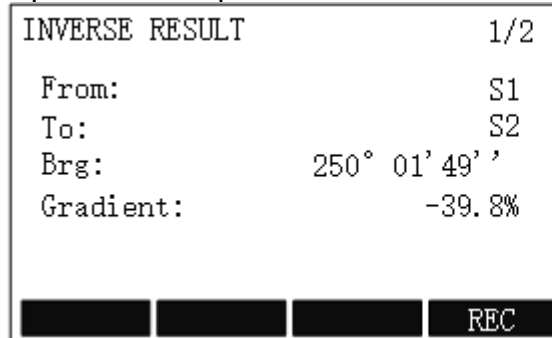

3. Press **F4 REC** for record. The display shows *Data Saved* and automatically returns to **INVERSE** display.

5.2.4.4.1.2 Set Traverse Computation

The principle is as follows:

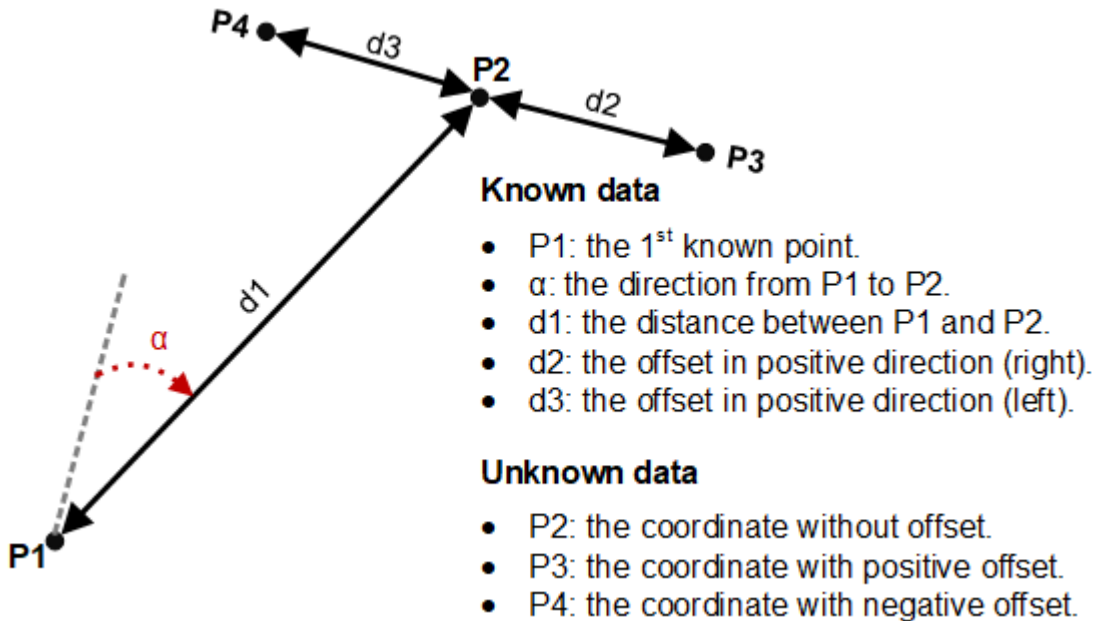

To set traverse computation, do the following:

1. To select **Traverse**, press **F1 / 1** in **COGO** display, and press **F2 / 2**.

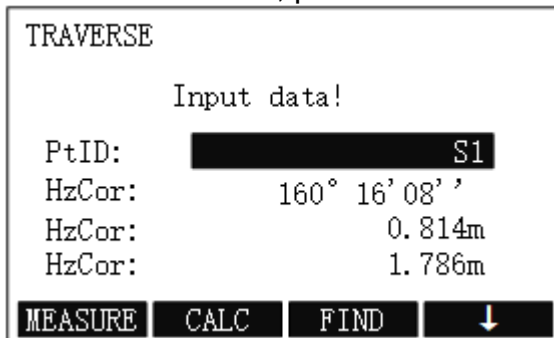

2. Input data, and press **F2 CALC** for computing. **TRAVERSE RESULT** display shows:

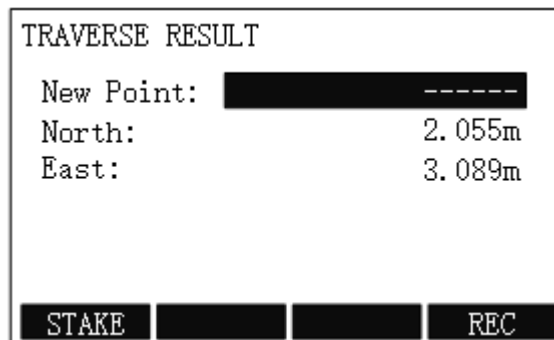

3. Input a name for the new point and press **F4 REC** for record. The display shows *Data Saved* and automatically returns to **TRAVERSE** display.

5.2.4.4.2 Set Intersections

To set intersections, do the following:

1. In **COGO** display, press **F2 / 2**. **INTERSECTIONS** display shows:

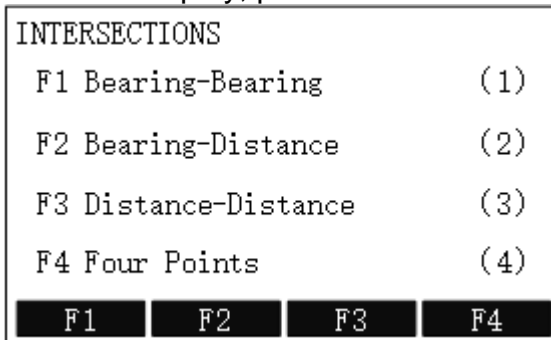

2. Do one of the following:
 - o Set Bearing-bearing
 - o Set Bearing-distance
 - o Set Distance-distance
 - o Set Four Points

5.2.4.4.2.1 Set Bearing-bearing

The principle is as follows:

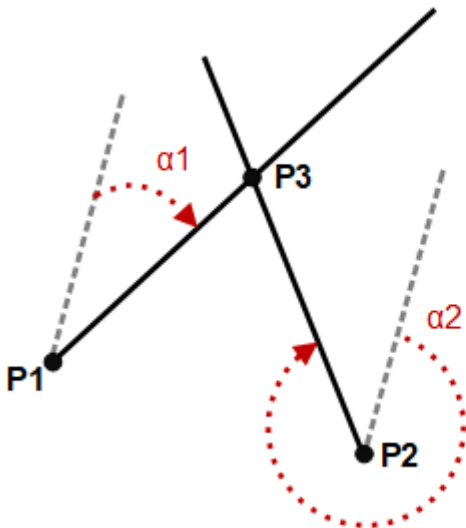

Known data

- P1: the 1st known point.
- P2: the 2nd known point.
- α_1 : the direction from P1 to P3.
- α_2 : the distance from P2 to P3.

Unknown data

- P3: the coordinate.

To set bearing-bearing, do the following:

1. In **INTERSECTIONS** display, press **F1 / 1**.

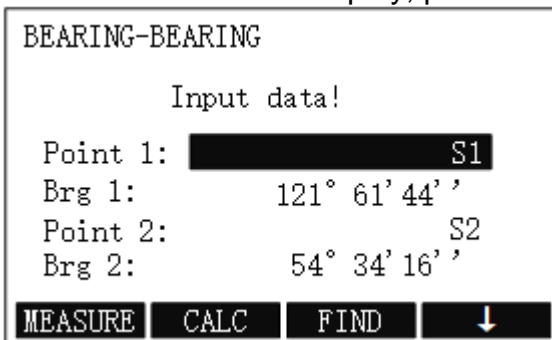

- Input data, and press **F2 CALC** for computing. **BEARING-BEARING** display shows:

```

BEARING-BEARING

New Point: ██████████
North:      45.928m
East:      63.445m

██████  ████████  ████████  REC
    
```

- Input a name for the new point and press **F4 REC** for record. The display shows *Data Saved* and automatically returns to **BEARING-BEARING** display.

5.2.4.4.2.2 Set Bearing-distance

The principle is as follows:

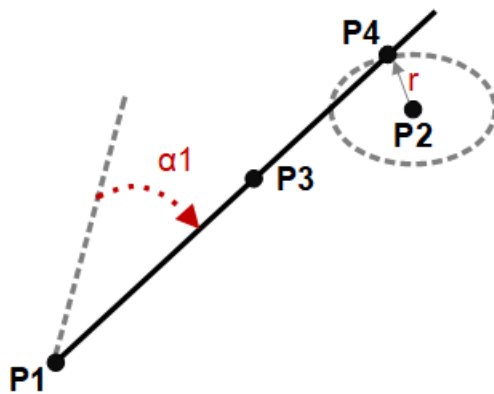

Known data

- P1: the 1st known point
- P2: the 2nd known point
- α : the direction from P1 to P3
- r: the radius, distance from P2 to P3/P4

Unknown data

- P3: the coordinate of 1st point
- P4: the coordinate of 2nd point

To set bearing-distance, do the following:

- In **INTERSECTIONS** display, press **F2 / 2**.

```

BEARING-DISTANCE

      Input data!

Point 1: ██████████ S1
Brg 1:   121° 61' 44" '
Point 2: ██████████ S2
HD 2:   21.352m

MEASURE  CALC  FIND  ↓
    
```

- Input data, and press **F2 CALC** for computing. **BEARING-DISTANCE** display shows:

```

BEARING-DISTANCE

PtID: ██████████
North: -48.506m
East:  130.929m
PtID:  -----m
North: -----m
East:  -----m

██████  ████████  ████████  REC
    
```

- Input a name for the new point and press **F4 REC** for record. The display shows *Data Saved* and automatically returns to **BEARING-DISTANCE** display.

5.2.4.4.2.3 Set Distance-distance

The principle is as follows:

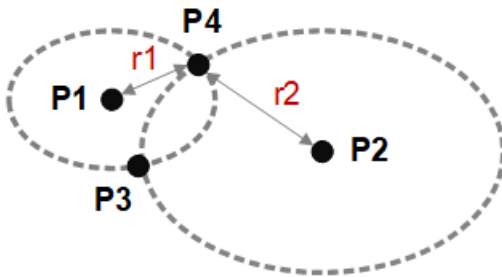

Known data

- P1: the 1st known point.
- P2: the 2nd known point.
- r1: the radius, distance from P1 to P3/P4.
- r2: the radius, distance from P2 to P3/P4.

Unknown data

- P3: the coordinate of 1st point
- P4: the coordinate of 2nd point

To set distance-distance, do the following:

- In **INTERSECTIONS** display, press **F3 / 3**.

```

DISTANCE-DISTANCE

      Input data!

Point 1: 
HD 1:           3.284m
Point 2: 
HD 2           6.626m

MEASURE  CALC  FIND  ↓
    
```

- Input data, and press **F2 CALC** for computing. **DISTANCE-DISTANCE** display shows:

```

DISTANCE-DISTANCE

PtID: 
North:           46.769m
East:            61.522m
PtID: m
North:           60.108m
East:            43.182m

STAKE    REC
    
```

- Input a name for the new point and press **F4 REC** for record. The display shows *Data Saved* and automatically returns to **DISTANCE-DISTANCE** display.

5.2.4.4.2.4 Set Four Points

The principle is as follows:

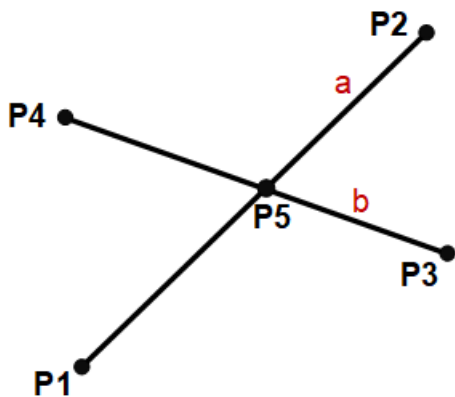

Known data

- P1: the 1st known point.
- P2: the 2nd known point.
- P3: the 3rd known point.
- P4: the 4th known point.
- a: the line from P1 to P2.
- b: the line from P3 to P4.

Unknown data

- P5: the coordinate.

To set four points, do the following:

1. In **INTERSECTIONS** display, press **F4 / 4**.

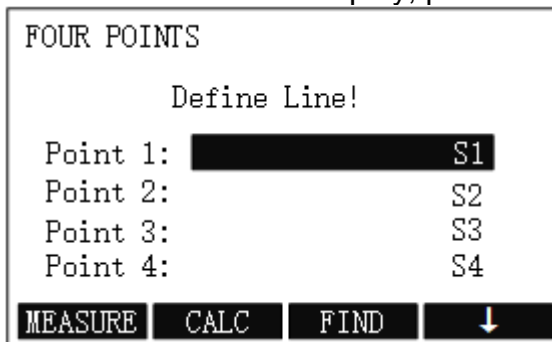

2. Input data, and press **F2 CALC** for computing. **DISTANCE-DISTANCE** display shows:

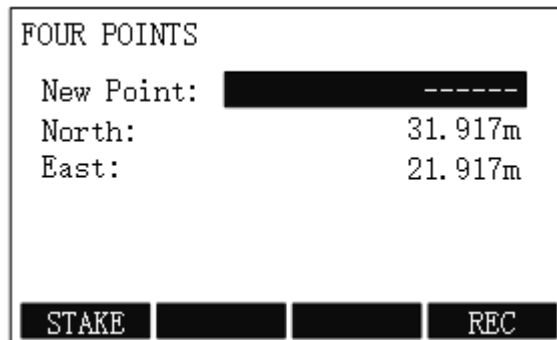

3. Input a name for the new point and press **F4 REC** for record. The display shows *Data Saved* and automatically returns to **FOUR POINTS** display.

5.2.4.4.3 Set Offset

To set offset, do the following:

1. In **COGO** display, press **F3 / 3**. **OFFSET** display shows:

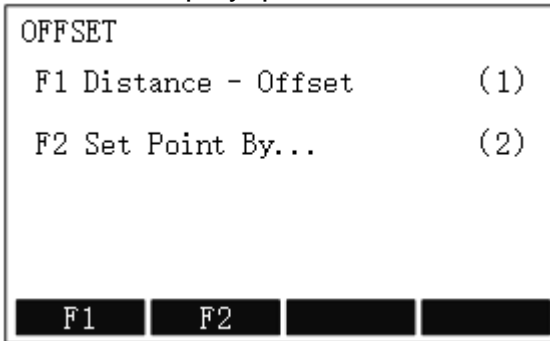

2. Do one of the following:
 - o Set Distance-offset
 - o Set Point by

5.2.4.4.3.1 Set Distance-offset

The principle is as follows:

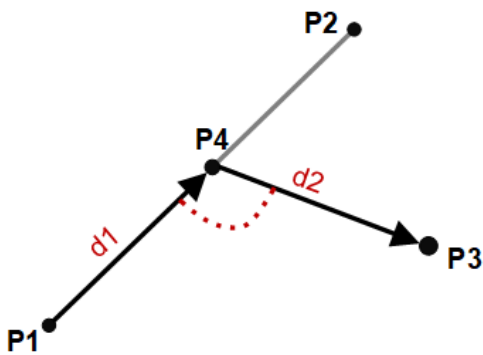

Known data

- P1: the start point of baseline.
- P2: the end point of baseline.
- P3: the horizontal offset point.

Unknown data

- d1: the vertical distance of P3 to the baseline (P4).
- d2: the distance of P1 to the foot of a perpendicular (P4).
- P4: the coordinate of foot of a perpendicular.

To set distance-offset, do the following:

1. To select **Distance-Offset**, in **OFFSET** display, press **F1 / 1**:

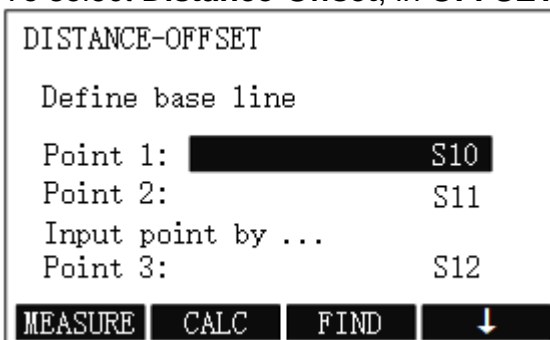

- Define the base line, and press **F2 CALC** for computing. **OFFSET RESULT** display shows:

```

OFFSET RESULT
Offset:          -9.063m
Line:           4.365m
Off. Coord:
New Point:      ██████████
North:         47.706m
East:          52.219m
STAKE ████████ REC
    
```

- Input a name for the new point and press **F4 REC** for record. The display shows *Data Saved* and automatically returns to **DISTANCE-OFFSET** display.

5.2.4.4.3.2 Set Point by

The principle is as follows:

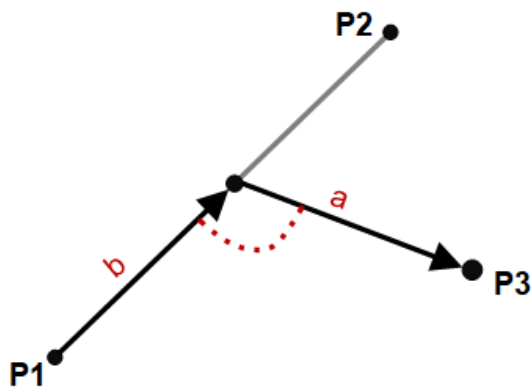

Known data

- P1: the start point of baseline
- P2: the end point of baseline
- a: the vertical distance of P3 to the baseline.
- b: distance of P1 to the foot of a perpendicular.

Unknown data

- P3: the coordinate of horizontal offset point.

To set point by, do the following:

- To select **Set Point by...**, in **OFFSET** display, press **F2 / 2**.

```

SET POINT BY...
Define base line
Point 1: ██████████ S10
Point 2: ██████████ S11
Input Offset & Line!
Line:          -----m
Offset:        -----m
MEASURE CALC FIND ↓
    
```

- Define the base line, input offset and line, and press **F2 CALC** for computing. **SET POINT BY** display shows:

```

SET POINT BY...

New Point: ██████████ -----
North:           -34.760m
East:           -94.742m

██████████  ██████████  ██████████  ██████████
    STAKE          REC
    
```

- Input a name for the new point and press **F4 REC** for record. The display shows *Data Saved* and automatically returns to **SET POINT BY** display.

5.2.4.4.4 Set Extension

The principle is as follows:

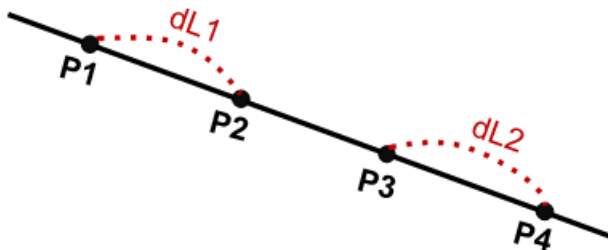

Known data

- P1: the start point of baseline.
- P3: the end point of baseline.
- dL1: the distance between P1 and P2.
- dL2: the distance between P3 and P4.

Unknown data

- P2: the coordinate.
- P4: the coordinate.

To set extension, do the following:

- In **COGO** display, press **F4 / 4**. **EXTENSION** display shows:

```

EXTENSION
  Define line!
Point 1: ██████████ S10
Point 2: ██████████ S11
  Select & Input!
BP:           S12 ◀▶
HD:           85.000m

██████████  ██████████  ██████████  ██████████
    MEASURE  CALC      FIND      ↓
    
```

- Input data, and press **F2 CALC** for computing. **OFFSET RESULT** display shows:

```

EXTENSION

New Point: ██████████ -----
North:           16.681m
East:           46.660m

██████████  ██████████  ██████████  ██████████
    STAKE          REC
    
```

- Input a name for the new point and press **F4 REC** for record. The display shows *Data Saved* and automatically returns to **EXTENSION** display.

5.2.5 Tie Distance

This program is used to calculate the slant distance, horizontal distance, height difference and azimuth of two target points measured in real time.

You can choose any of the following to accomplish this purpose:

- Polygonal method

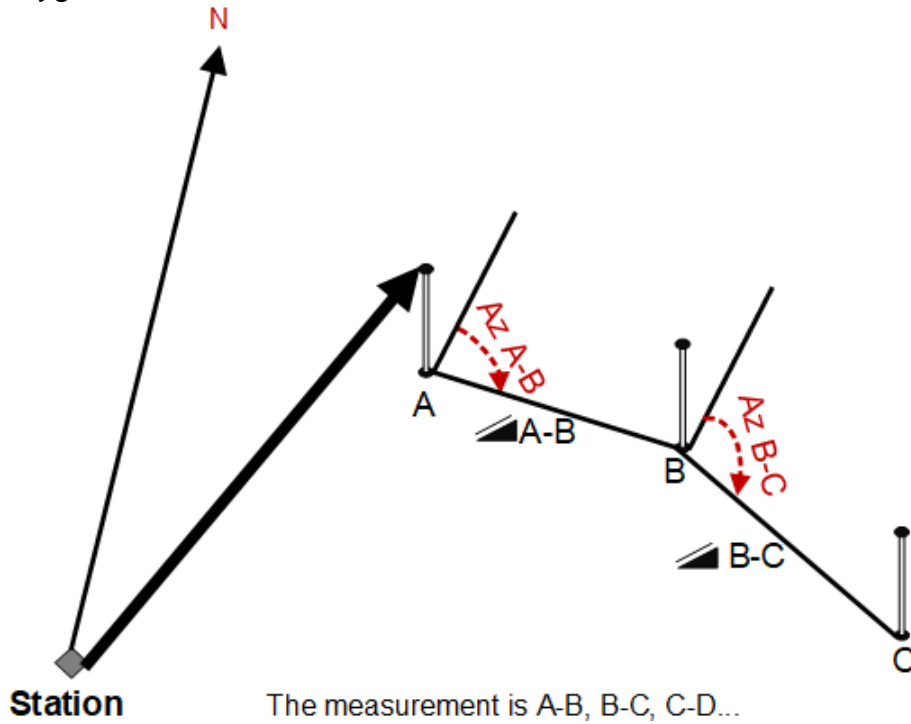

- Radial method

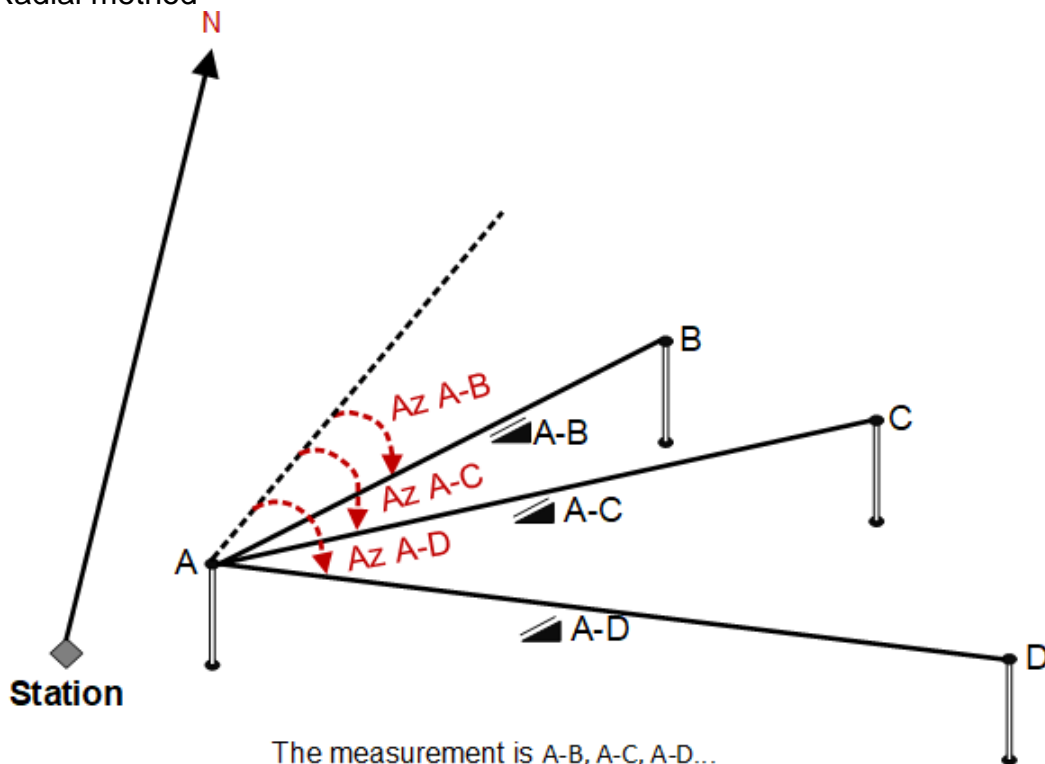

To set tie distance, do the following:

1. To enter **Program** menu page, press **MENU** and **F1** or **1**.
2. Press **PAGE** to go to the second page, and press **F1** or **5**:

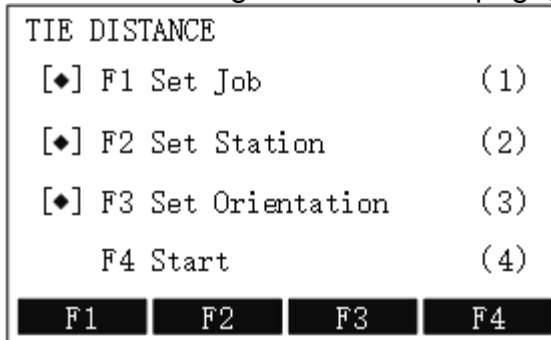

- [◆]: it indicates that settings are done.
 - []: it indicates that settings are not done.
3. Do the following:
 - a. [Set a Job](#)
If you have done it before, you can skip it.
 - b. [Set the Station](#)
If you have done it before, you can skip it.
 - c. [Set the Orientation](#)
If you have done it before, you can skip it.
 - d. [Start Tie Distance](#)

5.2.5.1 Set a Job

See [5.2.1.1 Set a Job](#) for details.

5.2.5.2 Set the Station

See [5.2.1.2 Set the Station](#) for details.

5.2.5.3 Set the Orientation

See [5.2.1.3 Set the Orientation](#) for details.

5.2.5.4 Start Tie Distance

To start tie distance, do the following:

1. To enter **TIE DISTANCE** display, in **TIE DISTANCE** display, press **F4 / 4**:

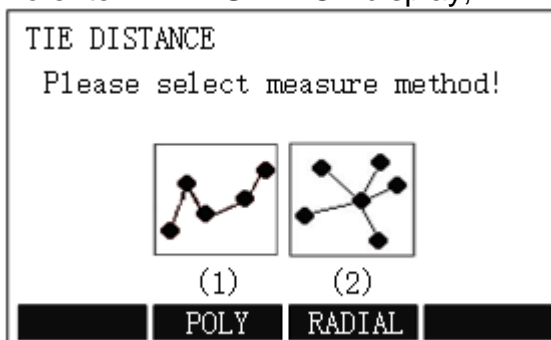

2. To select a measuring method, do one of the following:

- To select **Poly**, press **F2 / 1**.

POLYGONAL (A-B, B-C)		1/3
Point 1:	A1	
Rht:	1.500m	
:	0.979.m	
:	1.765.m	
ALL	FIND	LIST
		↓

- To select **Radial**, press **F3 / 2**.

RADIAL (A-B, A-C)		1/3
CP:	B1	
Rht:	1.500m	
:	1.754m	
:	1.753m	
ALL	FIND	LIST
		↓

3. To determine the first target point, press **F1 ALL**. The display shows *Data Saved*:

4. To determine the second point, press **F1 ALL**. The display shows *Data Saved*, and **TIE DISTANCE RESULT** display shows (taking polygonal method as an example):

TIE DISTANCE RESULT		1/2
Point 1:	A1	
Point 2:	A2	
Gradient:	1.3%	
dSD:	0.158m	
dHD:	0.157m	
dVD:	0.002m	
NewTie	NEWP	RADIAL

- **Gradient**: the grade (%) between point 1 and point 2.
- **dSD**: the slant distance between point 1 and point 2.
- **dHD**: the horizontal distance between point 1 and point 2.
- **dVD**: the height difference between point 1 and point 2.

5. Do the following based on your needs:
 - In polygonal method
 - To abandon the result and start measurement again, press **F1 NewTie**.
 - To start measurement for a new point, press **F2 NEWP**.
At this time, the result is based on the previously last measurement point and the new point.
 - In radial method
 - To determine a new centre point, press **F1 CentPt**.
At this time, the result is based on the previous radial point and the new centre point.
 - To determine a new radial point, press **F2 RadPt**.
At this time, the result is based on the previous centre point and the new radial point.
6. **Optional:** To switch to the radial / polygonal method, press **F4 RADIAL / POLY**.

5.2.6 Area and Volume

This program is used to calculate areas of points (30 points at most) connected by straights in real time.

The principle is as follows:

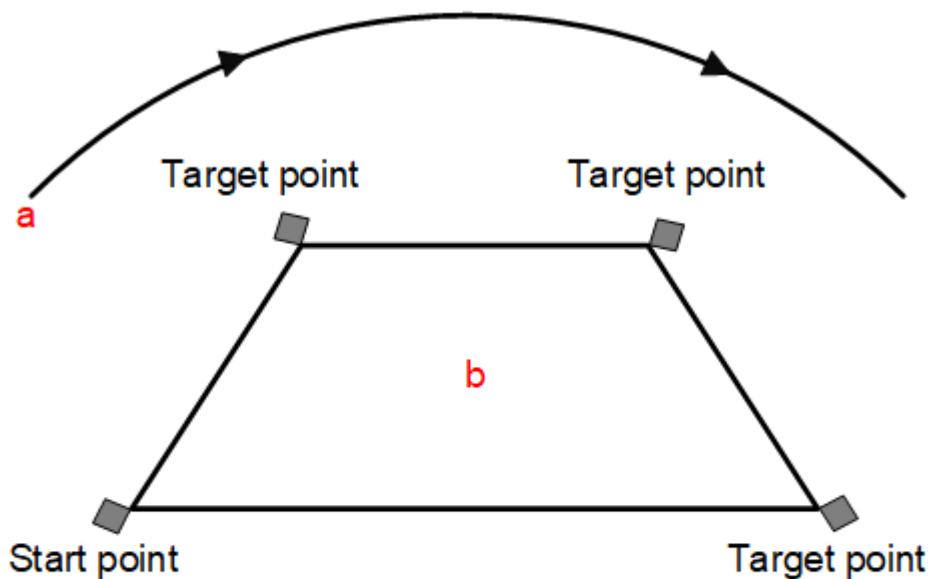

90

- ◆ **Station**
 - **a:** perimeter, the polygonal length from start point to the current measured point.
 - **b:** the calculated area, always closed to the start point.

The calculated area is projected onto the horizontal plane (2D) or projected onto the sloped reference plane defined by 3 points (3D). Furthermore a volume with constant height can be calculated with respect to the area (2D/3D):

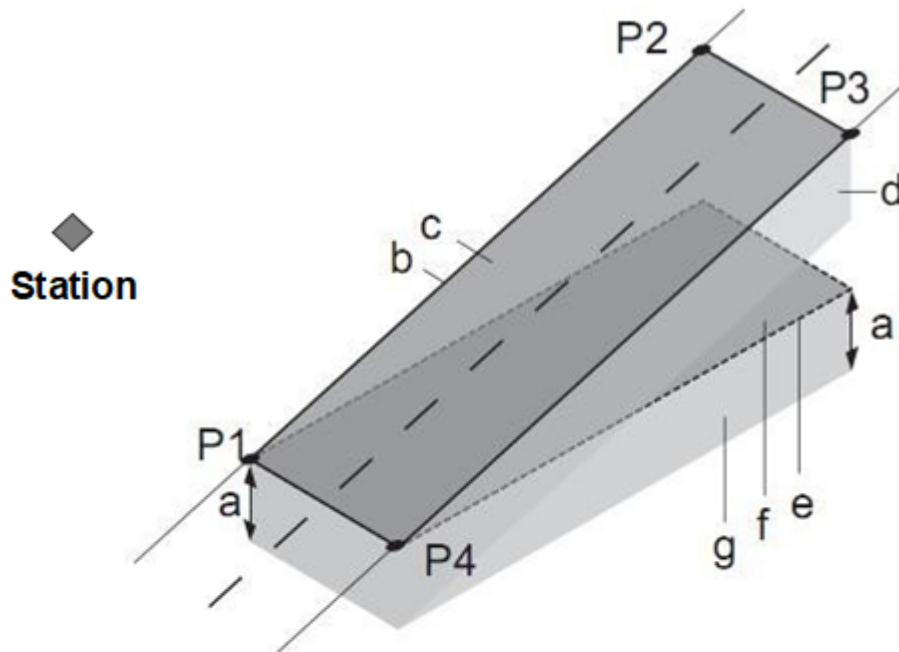

- **P1**: the target point that defines the sloped reference plane.
- **P2**: the target point that defines the sloped reference plane.
- **P3**: the target point that defines the sloped reference plane.
- **P4**: the target point That defines the sloped reference plane.
- **a**: constant height.
- **b**: perimeter (3D), the polygonal length from the start point to the current measured point of the area (3D).
- **c**: area (3D), projected onto the sloped reference plane
- **d**: volume (3D) = $a * c$
- **e**: perimeter (2D), the polygonal length from the start point to the current measured point of the area (2D).
- **f**: area (2D), projected onto the horizontal plane.
- **g**: volume (2D) = $f * a$

To set area and volume, do the following:

1. To enter **Program** menu page, press **MENU** and **F1** or **1**.
2. Press **PAGE** to go to the second page, and press **F2** or **6**:

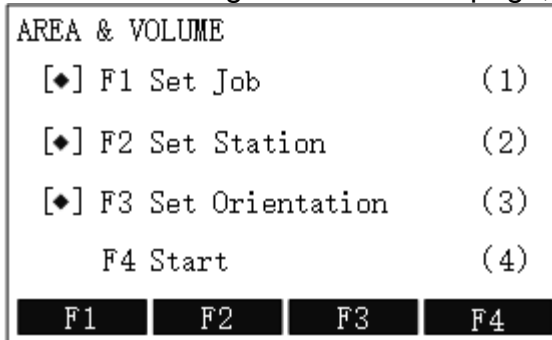

- [◆]: it indicates that settings are done.
 - []: it indicates that settings are not done.
3. Do the following:
 - a. [Set a Job](#)
If you have done it before, you can skip it.
 - b. [Set the Station](#)
If you have done it before, you can skip it.
 - c. [Set the Orientation](#)
If you have done it before, you can skip it.
 - d. [Start Area and Volume](#)

5.2.6.1 Set a Job

See [5.2.1.1 Set a Job](#) for details.

5.2.6.2 Set the Station

See [5.2.1.2 Set the Station](#) for details.

5.2.6.3 Set the Orientation

See [5.2.1.3 Set the Orientation](#) for details.

5.2.6.4 Start Area and Volume

To start area and volume, do the following:

1. To enter **AREA & VOLUME** display, in **AREA & VOLUME** display, press **F4 / 4**:

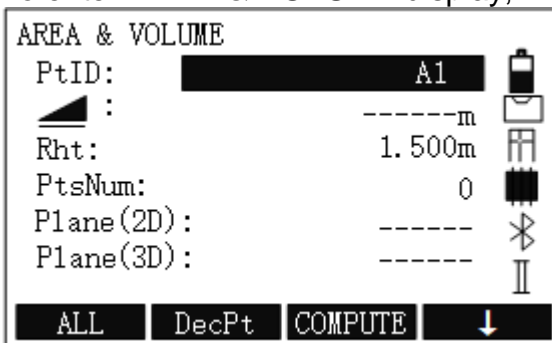

2. To determine area points, do one of the following:
 - To start measurement for the current point, press **F1 ALL**. The display shows *Data Saved*:
 - To search for points from the internal memory, press ↓ twice and press **F3 FIND**, or press ↓ three time and press **F1 LIST**.
 - To manually input the coordinates, press ↓ three times and press **ENH**.
At most 30 points are supported.
3. **Optional:** To undo measurement or selection of the last point, press **F2 DecPt**.
4. To check the result, press **F3 COMPUTE. AREA(2D)VOLUME MEASURE R** display shows:

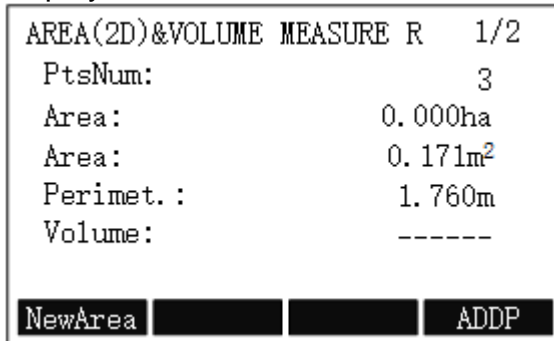

5.2.7 Remote Height

This program is used to calculate the height difference of a remote object relative to ground.

The start point of measurement differs in the following:

- With a prism: the start point is the prism (reference point).
- Without a prism: the start point is any reference point in which the vertical angle is established

Note: The reference point should be perpendicular to the remote object.

The principle is as follows:

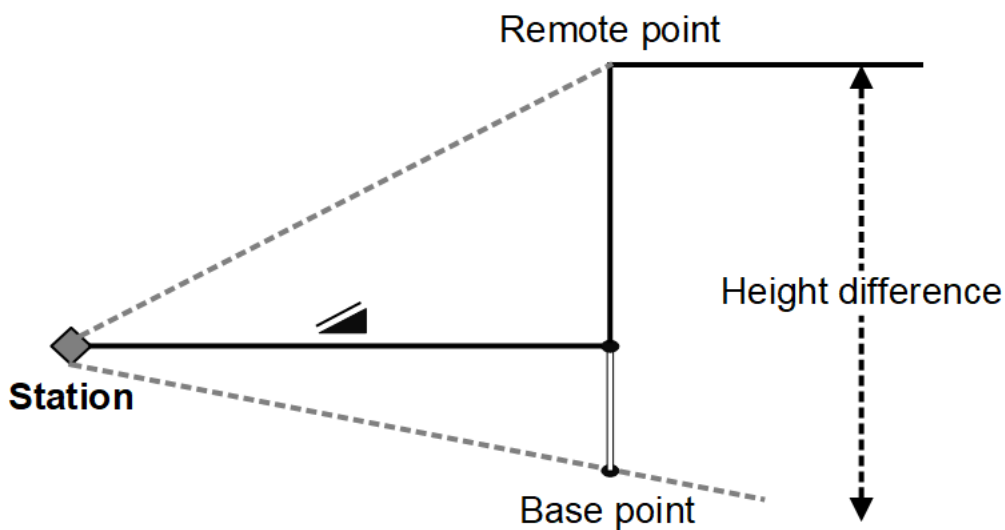

To set remote height, do the following:

1. To enter **Program** menu page, press **MENU** and **F1** or **1**.
2. Press **PAGE** to go to the second page, and press **F3** or **7**:

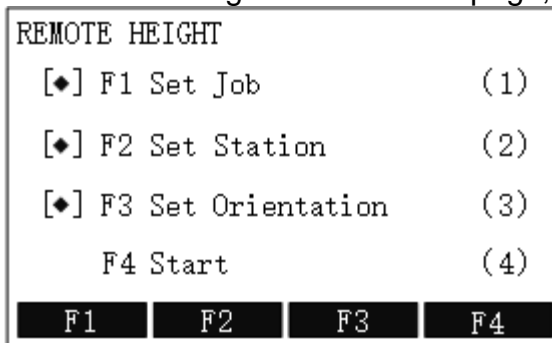

- [♦]: it indicates that settings are done.
 - []: it indicates that settings are not done.
3. Do the following:
 - a. [Set a Job](#)
If you have done it before, you can skip it.
 - b. [Set the Station](#)
If you have done it before, you can skip it.
 - c. [Set the Orientation](#)
If you have done it before, you can skip it.
 - d. [Start Remote Height](#)

5.2.7.1 Set a Job

See [5.2.1.1 Set a Job](#) for details.

5.2.7.2 Set the Station

See [5.2.1.2 Set the Station](#) for details.

5.2.7.3 Set the Orientation

See [5.2.1.3 Set the Orientation](#) for details.

5.2.7.4 Start Remote Height

To start remote height, do the following:

1. To enter **BASE POINT** display, in **REMOTE HEIGHT** display, press **F4 / 4**:

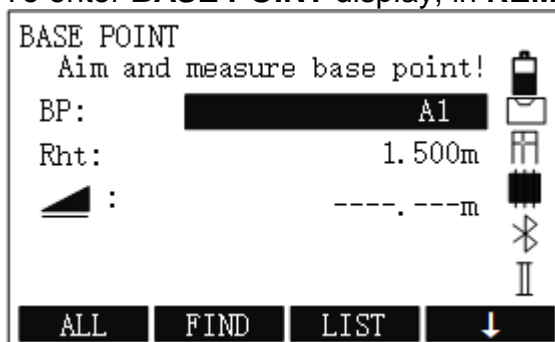

2. To input the height of reflector, and press **F1 ALL**. The display shows *Data Saved*.

3. Aim at the inaccessible remote point. The value of **dVD** and **H** shows:

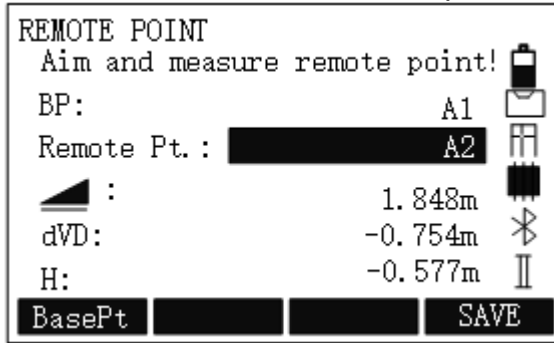

4. To save the measured data, press **F4 SAVE**.

5.2.8 Reference Line/Arc

To set reference line/arc, do the following:

1. To enter **Program** menu page, press **MENU** and **F1** or **1**.
2. Press **PAGE** to go to the second page, and press **F4** or **8**:

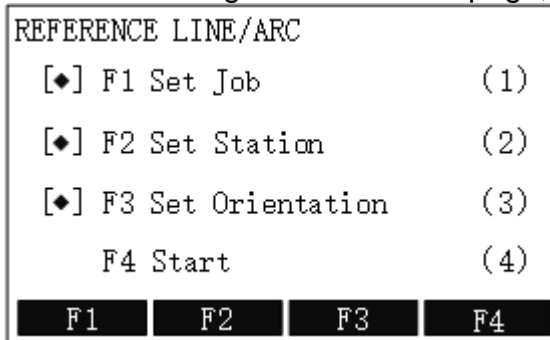

- o [◆]: it indicates that settings are done.
 - o []: it indicates that settings are not done.
3. Do the following:
- a. [Set a Job](#)
If you have done it before, you can skip it.
 - b. [Set the Station](#)
If you have done it before, you can skip it.
 - c. [Set the Orientation](#)
If you have done it before, you can skip it.
 - d. [Start Reference Line/Arc](#)

5.2.8.1 Set a Job

See [5.2.1.1 Set a Job](#) for details.

5.2.8.2 Set the Station

See [5.2.1.2 Set the Station](#) for details.

5.2.8.3 Set the Orientation

See [5.2.1.3 Set the Orientation](#) for details.

5.2.8.4 Start Reference Line/Arc

To start reference line/arc, do the following:

1. To enter **REFERENCE LINE/ARC** display, in **REFERENCE LINE/ARC** display, press **F4 / 4**:

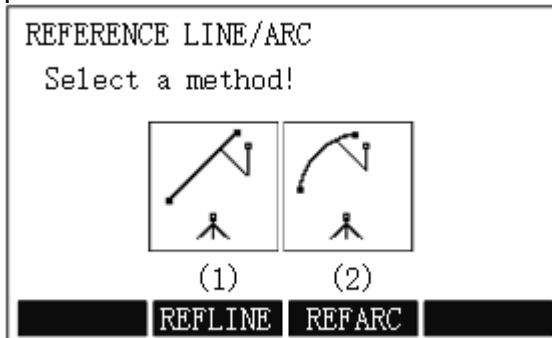

2. Do one of the following:
 - To **Set Reference Line**, press **F2 / 1**.
 - To **Set Reference Arc**, press **F3 / 2**.

5.2.8.4.1 Set Reference Line

To set reference line, do the following:

1. To select **REFLINE**, in **REFERENCE LINE/ARC** display, press **F2 / 1**:

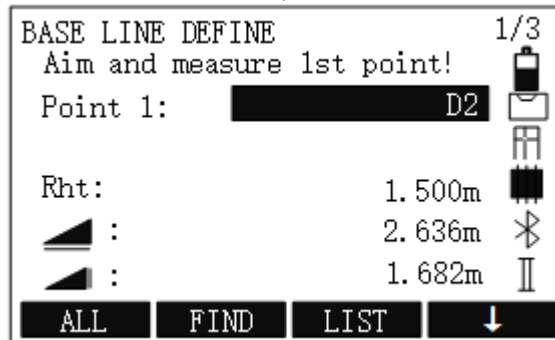

2. To determine the first point, press **F1 ALL**. The display shows *Data Saved*.
3. To determine the second point, press **F1 ALL**. The display shows *Data Saved*, and **REFERENCE LINE-MAIN** display shows:

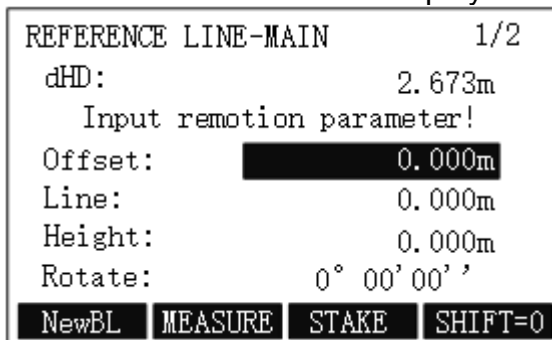

- Input remotion parameters, and press **F2 MEASURE** to enter **LINE OFFSET MEASURE** display, input data, and press **F1 ALL** to trigger measurement in **LINE OFFSET MEASURE** display:

LINE OFFSET MEASURE	
PtID:	D3
Rht:	1.500m
d Line:	-1.027m
d Off	-0.744m
dVD:	-0.047m

ALL DIST REC ↓

- In **REFERENCE LINE-MAIN** display, press **F3 STAKE**:

ORTHOGONAL ELEMENT INPUT	
Input orthogonal data!	
PtID:	D3
Rht:	1.200m
Line:	0.000m
Offset:	0.000m
Height:	0.800m

PREV SHIFT=0 ENT

- Input data for orthogonal staking out, including PtID, reflector height, longitudinal offset, transversal offset and height.
- Press **F4 ENT** for confirmation and start orthogonal staking out:

ORTHOGONAL STAKE OUT		1/2
PtID:	D3	
Rht:	1.500m	
dHz: →	23° 15' 32' '	
dHD: ---	----.---m	
dVD: ---	----.---m	

DIST REC AddPt ↓

- Press **↓ → F1 ALL** to trigger measurement.
- Optional:** To start staking out for the next point, press **F3 AddPt** and repeat step 6 ~ 8.

5.2.8.4.2 Set Reference Arc

To set reference arc, do the following:

1. To select **REFARC**, in **REFERENCE LINE/ARC** display, press **F2 / 1**:

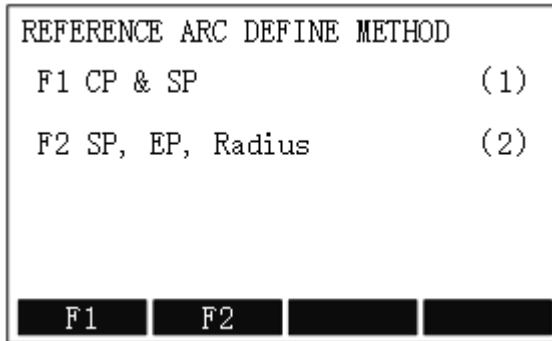

2. Do one of the following. **REFERENCE ARC** display shows:
 - o To select CP and SP, press **F1 / 1**.

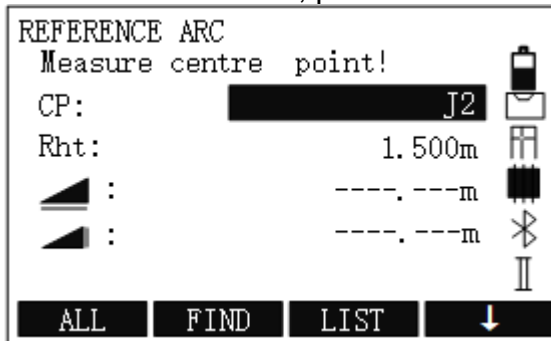

- o To select SP, EP, radius, press **F2 / 2**.

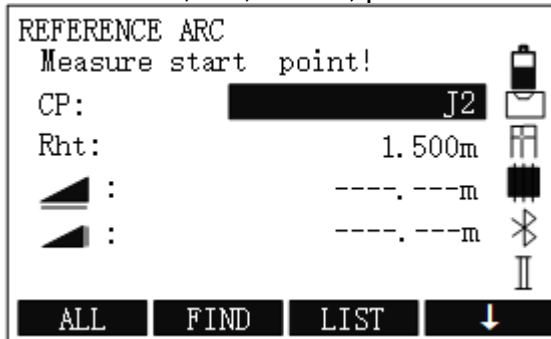

3. To measure the center point / start point, press **F1 ALL** to trigger measurement. The display shows *Data Saved*.

4. Press **F3 MEASURE** to enter **MEASURE ARC & RADIUS LENGTH** display, input data, and press \rightarrow **F1 ALL** to trigger measurement in **MEASURE ARC & RADIUS LENGTH** display:

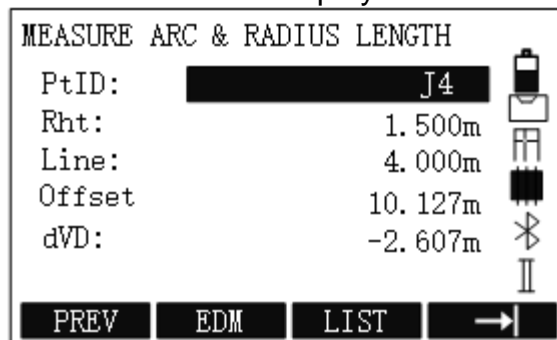

5. In **REFERENCE ARC-MAIN** display, press **F4 STAKE**:

REFERENCE ARC-STAKE OUT	
F1 Stake Out Point	(1)
F2 Stake Out Arc	(2)
F3 Stake Out Chord	(3)
F4 Stake Out Angle	(4)
F1	F2
F3	F4

6. Do staking out:

- a. Select a method to stake out:

- To select **Stake Out Point**, press **F1 / 1**:

STAKE OUT-POINT	
PtID:	J2
Line:	120.035m
Offset:	20.654m
RESET	ENT

- To select **Stake Out Arc**, press **F2 / 2**:

STAKE OUT-ARC	
PtID:	J2
Misclosure:	Start Point ◀▶
Arc Length:	25.021m
Line:	28.214m
Offset:	12.012m
RESET	PT-
PT+	ENT

- To select **Stake Out Chord**, press **F3 / 3**:

STAKE OUT-CHORD	
PtID:	J2
Misclosure:	Start Point ◀▶
Chord Length:	25.021m
Line:	28.214m
Offset:	12.012m
RESET	PT-
PT+	ENT

- To select **Stake Out Angle**, press **F4 / 4**:

STAKE OUT-ANGLE					
PtID:	J2				
Misclosure:	Start Point ◀▶				
Angle:	12° 24' 32''				
Line:	28.214m				
Offset:	12.012m				
<table border="0"> <tr> <td>RESET</td> <td>PT-</td> <td>PT+</td> <td>ENT</td> </tr> </table>		RESET	PT-	PT+	ENT
RESET	PT-	PT+	ENT		

- Input data, and press **F4 ENT** for confirmation:

REFERENCE ARC STAKE OUT					
PtID:	J2				
Rht:	1.500m				
dHz: →	0° 00' 02''				
dHD: ↑	12.189m				
dVD: ↓	-3.176m				
<table border="0"> <tr> <td>DIST</td> <td>REC</td> <td>AddPt</td> <td>↓</td> </tr> </table>		DIST	REC	AddPt	↓
DIST	REC	AddPt	↓		

- Press **F1 DIST** to trigger measurement.
 - Optional:** To start staking out for the next point, press **F3 AddPt** and repeat step 2 ~ 3.
- To measure the start point / end point, press **F1 ALL** to trigger measurement in **REFERENCE ARC-MAIN** display. The display shows *Data Saved*, and the following display shows:

REFERENCE ARC-MAIN				
CP:	J2			
SP:	J3			
EP:	-----			
Radius:	0.206m			
<table border="0"> <tr> <td>NewArc</td> <td>MEASURE</td> <td>STAKE</td> </tr> </table>		NewArc	MEASURE	STAKE
NewArc	MEASURE	STAKE		

- Optional:** If **SP, EP, Radius** is selected, enter the radius of the arc.

5.2.9 Construction

This program is used to define a construction site by combining set-up of the instrument along with a construction line, measuring and stake out points relative to the line.

To set construction, do the following:

1. To enter **Program** menu page, press **MENU** and **F1** or **1**.
2. Press **PAGE** to go to the third page, and press **F1** or **9**:

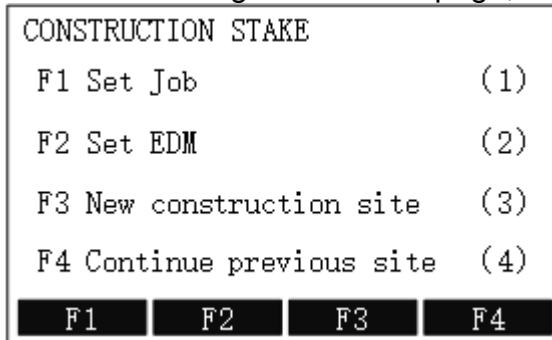

- [◆]: it indicates that settings are done.
 - []: it indicates that settings are not done.
3. Do the following:
 - a. [Set a Job](#)
If you have done it before, you can skip it.
 - b. [Set EDM](#)
 - c. [Set the New Construction Site](#)
 - d. [Continue the Previous Site](#)

5.2.9.1 Set a Job

See [5.2.1.1 Set a Job](#) for details.

5.2.9.2 Set EDM

See [5.4 EDM Menu](#) for details.

5.2.9.3 Set the New Construction Site

To set the new construction site, do the following:

1. To enter **CONSTRUCTION-STAKE POINT** display, in **CONSTRUCTION STAKE** display, press **F3 / 3**.

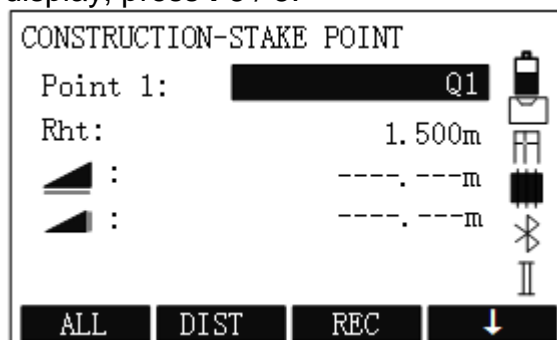

2. To determine the start point, press **F1 ALL**. The display shows *Data Saved*.

3. To determine the end point, press **F1 ALL**. The display shows *Data Saved*, and **STAKE OUT** display shows:

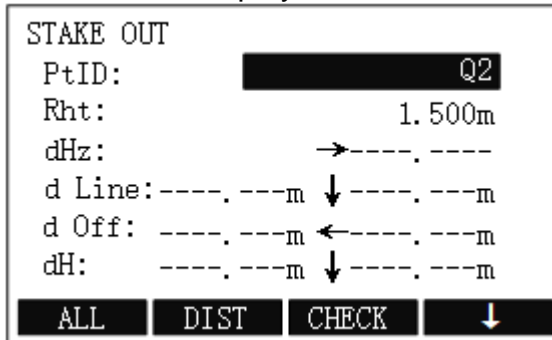

The figure shows the position of the prism in relation to the stake out point. Furthermore, the accurate values are displayed, combined with the arrows indicating the direction.

- **d Line**: if it is positive (↑), it means that the target point is further away than the measured point.
 - **d Off**: if it is positive (→), it means that the target point is on the right of the measured point.
 - **dH**: if it is positive (↑), it means that the target point is higher than the measured point.
4. Select a known point, and press **F1 ALL** to trigger measurement. The display shows the result of staking out:

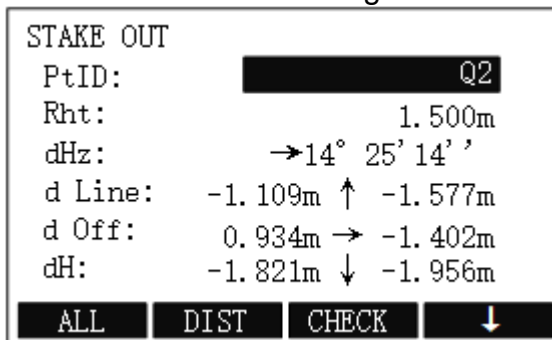

5.2.9.4 Continue the Previous Site

To continue the previous site, in **CONSTRUCTION STAKE** display, press **F4 / 4**.

See 5.2.9.3 [Set the New Construction Site](#) for details.

5.2.10 Lead Measure

This program is used for survey of hierarchical control traversing and mapping traversing etc. and adjustment and computation of closure.

To set the lead measurement, do the following:

1. To enter **Program** menu page, press **MENU** and **F1** or **1**.
2. Press **PAGE** to go to the third page, and press **F2** or **01**:

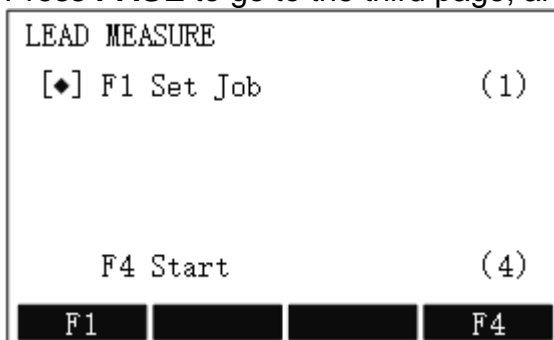

- [◆]: it indicates that settings are done.
 - []: it indicates that settings are not done.
3. Do the following:
 - a. [Set a Job](#)
If you have done it before, you can skip it.
 - b. [Start Lead Measurement](#)

5.2.10.1 Set a Job

See [5.2.1.1 Set a Job](#) for details.

5.2.10.2 Start Lead Measurement

To start lead measurement, do the following:

1. In **REFERENCE LINE/ARC** display, press **F4 / 4**. The following display shows:

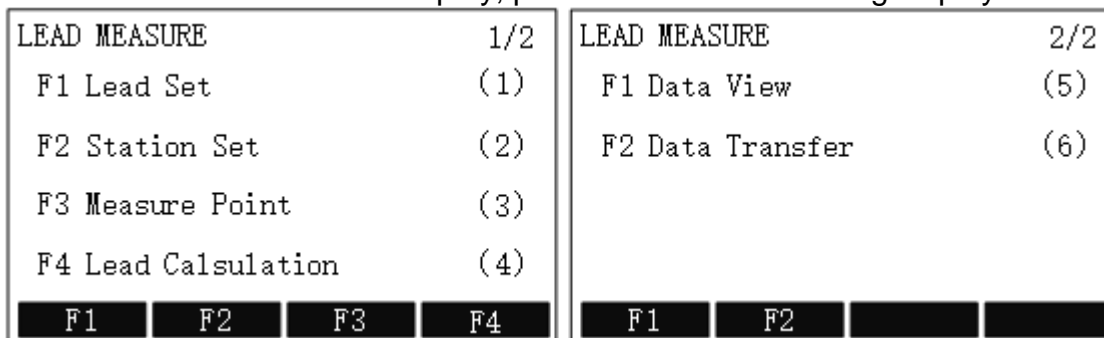

2. [Set the Lead](#)
3. [Set the Station](#)
4. [Measure the Point](#)
5. [Calculate the Lead](#)
6. [View Data](#)
7. [Transfer Data](#)

5.2.10.2.1 Set the Lead

To set the lead, do the following:

1. In **LEAD MEASURE** display, press **F1 / 1**. The following display shows:

LEAD SET	1/3
Old Lead:	DX ◀▶
New Lead:	DEFAULT
Lead Desc. :	-----
Meas Num:	1
EXIT	PREV SET

2. Set the following:
 - **New Lead:** a new lead name.
 - **Lead Desc.:** lead description.
 - **Meas Num:** the number of observation sets.
3. Press **PAGE / F4 SET** to go to the second page, and set the following:

LEAD SET	2/3
Lead Name:	DX
First Stn:	-----
Lead Bs Pt:	-----
Start Brg:	38° 09' 26' '
EXIT	PREV SET

- **First Stn:** the first survey station
 - **Lead Bs Pt:** the lead backsight point
 - **Start Brg:** the initial azimuth
4. Press **PAGE / F4 SET** to go to the third page, and set the following:

LEAD SET	3/3
Lead Name:	DX
V_Obs_Tol. :	0° 00' 09' '
Vindex Tol:	0° 00' 10' '
Hz_2c_Tol. :	0° 00' 18' '
Hz_Obs_Tol. :	0° 00' 12' '
EXIT	PREV SET

- **V_Obs_Tol:** the discrepancy tolerance of vertical angles among observation sets.
- **Vindex Tol:** the discrepancy tolerance of vertical index error.
- **Hz_2c_Tol:** the discrepancy tolerance of horizontal collimation error C.
- **Hz_Obs_Tol:** the discrepancy tolerance of horizontal angles among observation sets.

 **Note:** The horizontal angle defaults to tolerance of engineering first-order traverse, and vertical angle defaults to tolerance of the fifth class triangular elevation.

5. Press **F4 SET** for confirmation.

5.2.10.2.2 Set the Station

To set the station, do the following:

1. In **LEAD MEASURE** display, press **F2 / 2**. The following display shows:

STATION SET					
Known Stn:	[REDACTED] ◀▶				
New Stn:	22				
Hi:	1.200m				
BsPt:	HS				
Point:	QS				
<table border="1" style="width: 100%; border-collapse: collapse;"> <tr> <td style="width: 25%;">PREV</td> <td style="width: 25%;"></td> <td style="width: 25%;"></td> <td style="width: 25%;">SET</td> </tr> </table>		PREV			SET
PREV			SET		

2. Set the following:

- **New Stn:** a new survey station.
- **Hi:** the height of the instrument.

 **Note:** This value is defaulted to **0**. Please input an accurate value before next step. Otherwise, the buzzer sounds and the proceeding operation is impossible.

- **BsPt:** the backsight point.
- **Point:** the foresight point.







3. Press **F4 SET** for confirmation.

If a mistake is found after station setting succeeds, press **ESC** to quit the entire program and reenter.

5.2.10.2.3 Measure the Point

To measure the point, do the following:

1. In **LEAD MEASURE** display, press **F3 / 3**. The following display shows:

MEASURE LEAD POINT		1/3				
Station:	22					
ObsPt:	10					
Rht:	[REDACTED] 0.000m					
Meas Num:	1					
Hz:	222° 36' 43''					
V:	86° 29' 38''					
<table border="1" style="width: 100%; border-collapse: collapse;"> <tr> <td style="width: 25%;">ALL</td> <td style="width: 25%;">DIST</td> <td style="width: 25%;">REC</td> <td style="width: 25%;">ORI</td> </tr> </table>			ALL	DIST	REC	ORI
ALL	DIST	REC	ORI			

2. Set the following:

- **Rht:** the height of the prism.
- **Meas Num:** the number of observation sets.

3. Press **F1 ALL** to trigger measurement.

- Turn the face, aim at the same point, and press **F1 ALL** to trigger measurement. The measurement order is backsight (face left) → foresight (face left) → foresight (face right) → backsight (face right).

5.2.10.2.4 Calculate the Lead

Before calculating the lead, make sure all station surveys are complete.

To calculate the lead, do the following:

- In **LEAD MEASURE** display, press **F4 / 4**. The following display shows:

LEAD CALCULATION	
Lead Name:	DX
Lead Desc.:	-----
Press ENT select station!	
Last Stn:	████████
Last FsPt:	-----
End Azimuth:	___° __' __' '
PREV	CALC

- If the lead belongs to branch traverse, press **F4 CALC** to compute coordinates of each lead point of branch traverse:

LEAD CLOSURE	1/2	
Lead Name:	DX	
LeadPt Num:	2	
Lead Length:	6.020m	
Pla. Closure:	13.088m	
Ver. Closure:	-5.213m	
Ang. Closure:	355° 21' 37' '	
PREV	MORE	ENT

LEAD CLOSURE	2/2	
Lead Name:	DX	
dX/N:	-9.070m	
dY/E:	-9.436m	
dH:	-5.213m	
P_Precision:	0.460	
V_Precision:	1.155	
PREV	MORE	ENT

- To check calculation results, especially coordinates of each lead point after computing, press **F2 MORE**:

AJUSTMENT RESULTS	
Point:	████████◀▶
North:	0.000m
East:	0.000m
Height:	0.000m
PREV	ENT

5.2.10.2.5 View Data

To view data, do the following

1. In **LEAD MEASURE** display, press **PAGE** to go to the second page, and press **F1 / 5**. The following display shows:

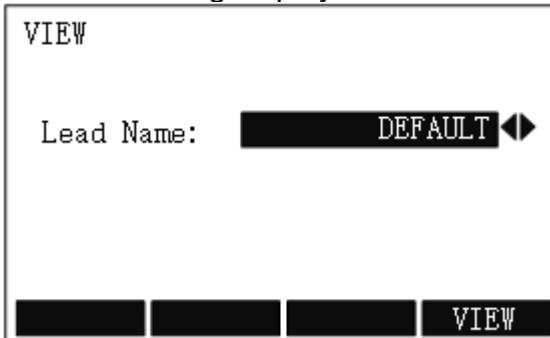

2. Select the target lead, and press **F4 VIEW**.

5.2.10.2.6 Transfer Data

It is used to send data to your PC.

To transfer data, do the following

1. In **LEAD MEASURE** display, press **PAGE** to go to the second page, and press **F2 / 6**. The following display shows:

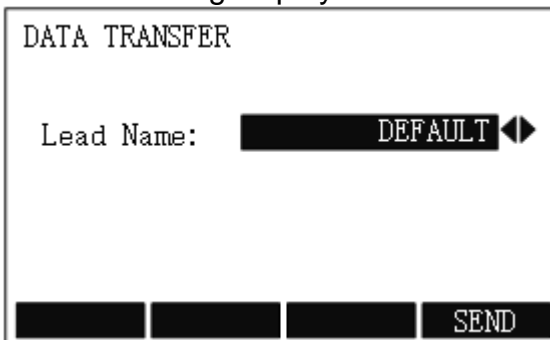

2. Select the target lead, and press **F4 SEND**.

5.2.11 2D-Road

To set the 2D-road, do the following:

1. To enter **Program** menu page, press **MENU** and **F1** or **1**.
2. Press **PAGE** to go to the third page, and press **F3** or **02**:

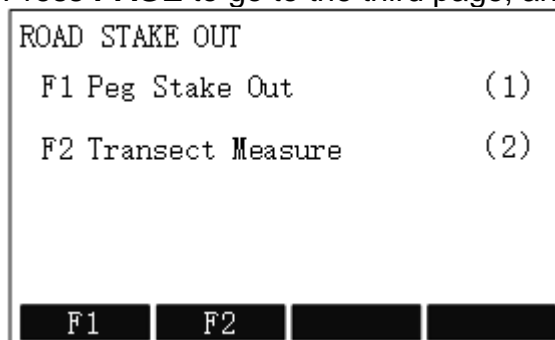

- [◆]: it indicates that settings are done.
- []: it indicates that settings are not done.

3. Do the following:
 - a. [Set a Job](#)
If you have done it before, you can skip it.
 - b. [Set the Station](#)
If you have done it before, you can skip it.
 - c. [Set the Orientation](#)
If you have done it before, you can skip it.
 - d. [Start 2D-Road](#)

5.2.11.1 Set a Job

See [5.2.1.1 Set a Job](#) for details.

5.2.11.2 Set the Station

See [5.2.1.2 Set the Station](#) for details.

5.2.11.3 Set the Orientation

See [5.2.1.3 Set the Orientation](#) for details.

5.2.11.4 Start 2D-Road

To start 2D-road, do the following:

1. In **ROAD STAKE OUT** display, press **F4 / 4**. The following display shows:

ROAD MENU			
F1	Road Define	(1)	
F2	Road Stake Out	(2)	
F3	Data View	(3)	
F4	Data Transfer	(4)	
F1	F2	F3	F4

2. Do the following:
 - [Define Road](#)
 - [Set Road Staking out](#)
 - [View Data](#)
 - [Transfer Data](#)

5.2.11.4.1 Define Road

To define road, do the following:

1. To enter **ROAD DEFINE** display, in **ROAD MENU** display, press **F1 / 1**:

ROAD DEFINE					
F1 Reference Point Data	(1)				
F2 Road(2D) Define Data	(2)				
<table border="1"> <tr> <td>F1</td> <td>F2</td> <td></td> <td></td> </tr> </table>		F1	F2		
F1	F2				

2. [Set a Reference Point](#)
3. [Define Road\(2D\) Data](#)

5.2.11.4.1.1 Set a Reference Point

Point here means reference point (control point), including each grade of the known plane point and known elevation point that can be used for setting station and orientation.

To set a reference point, do the following:

1. To enter **REFERENCE POINT VIEW** display, in **ROAD DEFINE** display, press **F1 / 1**:

REFERENCE POINT VIEW	34/34			
PtID:	<input type="text" value="7"/>			
North:	2.000m			
East:	3.000m			
Height:	0.000m			
Remark:				
<table border="1"> <tr> <td>ADD</td> <td></td> <td>DELETE</td> </tr> </table>		ADD		DELETE
ADD		DELETE		

2. To add a new reference point, press **F1 ADD**, and input data:

INPUT REFERENCE POINT				
PtID:	<input type="text" value="-----"/>			
North:	-----, ---m			
East:	-----, ---m			
H:	-----, ---m			
Remark:	-----			
<table border="1"> <tr> <td>SAVE</td> <td></td> <td>PREV</td> </tr> </table>		SAVE		PREV
SAVE		PREV		

3. **Optional:** To delete the current displayed reference point, press **F4 DELETE**.

5.2.11.4.1.2 Define Road(2D) Data

It is used to describe and determine road center lines.

There are the following models available for definition of road(2D):

- Main point
- Intersection point

To define road(2D) data, do the following:

1. To enter **SELECT ROAD(2D) DEFINE MODLE** display, in **ROAD DEFINE** display, press **F2 / 2**:

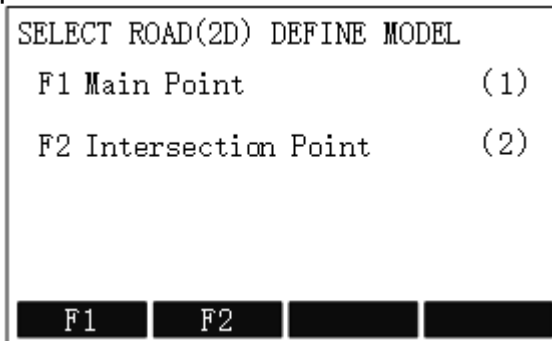

2. Select a model:
 - [Set Main Point](#)
 - [Set Intersection Point](#)



Note:

When using any of the definition of road (2D), please note the following:

- When using intersection point method, please input data successively in accordance with mileage (small to large) of intersection point. And the first and the last intersection point should be on the straight line segment of the road centre line.
- When using main point method, please do not miss out any main point finally. It's recommended to input data successively according to mileage magnitude for check and verification.
- The datum input with main point method cannot be viewed and edited in the form of intersection point method. But the datum input with intersection point method can be viewed and added in the form of main point, except for deletion.
- Affected by precision of turn angle, deviation may exists in main point datum converted by intersection point datum.
- No matter what kind of method you use, at least two valid main points or intersection points are required for normal staking out and measuring.
- No matter what kind of method you use, its maximum mileage should not be greater than 4294000.000m (i.e. K4294+000.000m).

5.2.11.4.1.2.1 Set Main Point

Utilizing main point information relative to the line to describe the entire road, it is the key point where the line type changes along with the line. It is used to solve any complicated line type including ramp.

To set main point, do the following:

1. To select **Main Point**, in **SELECT ROAD(2D) DEFINE MODLE** display, press **F1 / 1**:

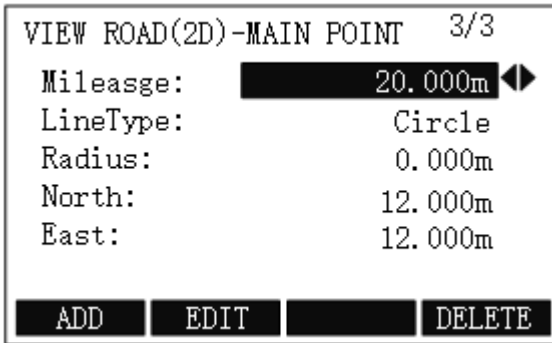

- **Mileage**: the stake mark of main point on the road centre line. Certain characters **K, k** and **+** etc. cannot be contained. e.g. K2+224.224 should be input as 2224.224.
- **LineType**: the line type of route preceding main point (big stake mark direction), including line, circle (round curve), spiral (easement curve) and end point.
- **Radius**: the radius of curvature of one side preceding main point (big stake mark direction), except the end point of route. When the route turns left, the radius will be negative; when the route turns right, it will be positive. When the radius of curvature is infinite, the value should be set to **99999999.999** or **-99999999.999**.

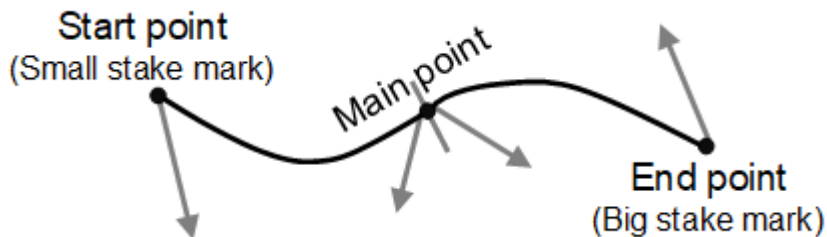

- **North**: the ordinate of the main point.
 - **East**: the abscissa of the main point.
2. To modify data, press **F2 EDIT**.
 3. To add a new main point, press **F1 ADD**, input data:

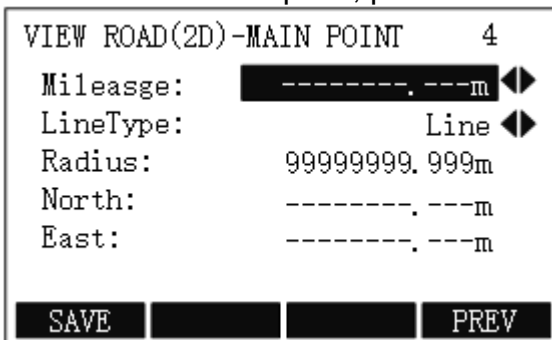

4. **Optional**: To delete the current displayed main point, press **F4 DELETE**.

5.2.11.4.1.2.2 Set Intersection Point

It is used to describe the entire road with information of intersection point of the route. This method is appropriate for the line type whose intersection points are symmetrical (i.e. their corresponding tangent lines are equilateral), and start point and end point of the route are on the straight line segment or its vertex points.

To set intersection point, do the following:

1. To select **Intersection Point**, in **SELECT ROAD(2D) DEFINE MODLE** display, press **F2 / 2**:

```

VIEW ROAD(2D)-INTERSECTION  2/2
Mileasge:  220.000m
North:      2.000m
East:       4.000m
Turn:       0° 00' 00' '
Radius:     9.000m
Spiral Len: 6.000m
ADD  EDIT  DELETE
    
```

- **Mileage**: the stake mark of intersection point. Certain characters **K, k** and **+** etc. cannot be contained. e.g. K2+224.224 should be input as 2224.224.
 - **North**: the ordinate of the intersection point.
 - **East**: the abscissa of the intersection point.
 - **Turn**: the turn angle of an intersection point relative to the route. Turn angles of start point and end point should be set to **0**.
 - **Radius**: the radius of curvature of circular curve corresponding to intersection point. When the route turns left, the radius will be negative; when the route turns right, it will be positive. At the start point and end point of route, the value should be set to **99999999.999** or **-99999999.999**.
 - **Spiral Len**: the easement curve length relevant to the intersection point. Please set it to **0** when there is no easement curve.
2. To modify data, press **F2 EDIT**.
 3. To add a new intersection point, press **F1 ADD**, input data:

```

VIEW ROAD(2D)-INTERSECTION  3
Mileasge:  -----m
North:     -----m
East:      -----m
Turn:      ___° __' __' '
Radius:    -----m
Spiral Len: -----m
SAVE  PREV
    
```

4. **Optional**: To delete the current displayed intersection point and other intersection points whose mileage is larger than the current one, press **F4 DELETE**.

5.2.11.4.2 Set Road Staking out

To set road staking out, do the following:

1. To enter **ROAD STAKE OUT** display, in **ROAD MENU** display, press **F2 / 2**:

ROAD STAKE OUT					
F1 Peg Stake Out	(1)				
F2 Transect Measure	(2)				
<table border="1" style="width: 100%; text-align: center;"> <tr> <td>F1</td> <td>F2</td> <td></td> <td></td> </tr> </table>		F1	F2		
F1	F2				

2. Do one of the following:

- o To select **Peg Stake Out**, press **F1 / 1**:

<table border="1"> <tr> <td colspan="2">PEG STAKE OUT</td> <td style="text-align: right;">1/2</td> </tr> <tr> <td>Mileadge:</td> <td>5.000m</td> <td></td> </tr> <tr> <td>Rht:</td> <td>2.000m</td> <td></td> </tr> <tr> <td>Brg:</td> <td>99° 24' 46' '</td> <td></td> </tr> <tr> <td>Off.Back:</td> <td>23.000m</td> <td></td> </tr> <tr> <td>Off.Left:</td> <td>23.000m</td> <td></td> </tr> <tr> <td>Remark:</td> <td>ZY</td> <td></td> </tr> <tr> <td colspan="3" style="text-align: center;"> <table border="1" style="width: 100%;"> <tr> <td>MEASURE</td> <td>REC</td> <td>ReStake</td> <td>ENH</td> </tr> </table> </td> </tr> </table>	PEG STAKE OUT		1/2	Mileadge:	5.000m		Rht:	2.000m		Brg:	99° 24' 46' '		Off.Back:	23.000m		Off.Left:	23.000m		Remark:	ZY		<table border="1" style="width: 100%;"> <tr> <td>MEASURE</td> <td>REC</td> <td>ReStake</td> <td>ENH</td> </tr> </table>			MEASURE	REC	ReStake	ENH	<table border="1"> <tr> <td colspan="2">PEG STAKE OUT</td> <td style="text-align: right;">2/2</td> </tr> <tr> <td>ProjST:</td> <td>----.---m</td> <td></td> </tr> <tr> <td>Wide:</td> <td>----.---m</td> <td></td> </tr> <tr> <td>Mile.Diff</td> <td>----.---m</td> <td></td> </tr> <tr> <td>Stake Dist:</td> <td>20.000m</td> <td></td> </tr> <tr> <td>Offset:</td> <td>12.000m</td> <td></td> </tr> <tr> <td>Def.Ang:</td> <td>3° 12' 23' '</td> <td></td> </tr> <tr> <td colspan="3" style="text-align: center;"> <table border="1" style="width: 100%;"> <tr> <td>EDM</td> <td>SaveAs</td> <td>PROJ</td> </tr> </table> </td> </tr> </table>	PEG STAKE OUT		2/2	ProjST:	----.---m		Wide:	----.---m		Mile.Diff	----.---m		Stake Dist:	20.000m		Offset:	12.000m		Def.Ang:	3° 12' 23' '		<table border="1" style="width: 100%;"> <tr> <td>EDM</td> <td>SaveAs</td> <td>PROJ</td> </tr> </table>			EDM	SaveAs	PROJ
PEG STAKE OUT		1/2																																																						
Mileadge:	5.000m																																																							
Rht:	2.000m																																																							
Brg:	99° 24' 46' '																																																							
Off.Back:	23.000m																																																							
Off.Left:	23.000m																																																							
Remark:	ZY																																																							
<table border="1" style="width: 100%;"> <tr> <td>MEASURE</td> <td>REC</td> <td>ReStake</td> <td>ENH</td> </tr> </table>			MEASURE	REC	ReStake	ENH																																																		
MEASURE	REC	ReStake	ENH																																																					
PEG STAKE OUT		2/2																																																						
ProjST:	----.---m																																																							
Wide:	----.---m																																																							
Mile.Diff	----.---m																																																							
Stake Dist:	20.000m																																																							
Offset:	12.000m																																																							
Def.Ang:	3° 12' 23' '																																																							
<table border="1" style="width: 100%;"> <tr> <td>EDM</td> <td>SaveAs</td> <td>PROJ</td> </tr> </table>			EDM	SaveAs	PROJ																																																			
EDM	SaveAs	PROJ																																																						

- o To select **Transect Measure**, press **F2 / 2**:

<table border="1"> <tr> <td colspan="2">TRANSECT MEASURE</td> <td style="text-align: right;">1/2</td> </tr> <tr> <td>Mileadge:</td> <td>12000m</td> <td></td> </tr> <tr> <td>Rht:</td> <td>1.500m</td> <td></td> </tr> <tr> <td>Wide:</td> <td>----.---m</td> <td></td> </tr> <tr> <td>Mile.Diff:</td> <td>----.---m</td> <td></td> </tr> <tr> <td></td> <td>----.---m</td> <td></td> </tr> <tr> <td>Remark:</td> <td>-----</td> <td></td> </tr> <tr> <td colspan="3" style="text-align: center;"> <table border="1" style="width: 100%;"> <tr> <td>MEASURE</td> <td>REC</td> <td>EDM</td> <td>FINISH</td> </tr> </table> </td> </tr> </table>	TRANSECT MEASURE		1/2	Mileadge:	12000m		Rht:	1.500m		Wide:	----.---m		Mile.Diff:	----.---m			----.---m		Remark:	-----		<table border="1" style="width: 100%;"> <tr> <td>MEASURE</td> <td>REC</td> <td>EDM</td> <td>FINISH</td> </tr> </table>			MEASURE	REC	EDM	FINISH	<table border="1"> <tr> <td colspan="2">TRANSECT MEASURE</td> <td style="text-align: right;">2/2</td> </tr> <tr> <td>Stn Mileage:</td> <td>-----</td> <td></td> </tr> <tr> <td>North:</td> <td>-----m</td> <td></td> </tr> <tr> <td>East:</td> <td>-----m</td> <td></td> </tr> <tr> <td>Height:</td> <td>-----m</td> <td></td> </tr> <tr> <td>Stake Dist:</td> <td>20.000m</td> <td></td> </tr> <tr> <td>Brg:</td> <td>45° 07' 59' '</td> <td></td> </tr> <tr> <td colspan="3" style="text-align: center;"> <table border="1" style="width: 100%;"> <tr> <td>MEASURE</td> <td></td> <td>SaveAs</td> </tr> </table> </td> </tr> </table>	TRANSECT MEASURE		2/2	Stn Mileage:	-----		North:	-----m		East:	-----m		Height:	-----m		Stake Dist:	20.000m		Brg:	45° 07' 59' '		<table border="1" style="width: 100%;"> <tr> <td>MEASURE</td> <td></td> <td>SaveAs</td> </tr> </table>			MEASURE		SaveAs
TRANSECT MEASURE		1/2																																																						
Mileadge:	12000m																																																							
Rht:	1.500m																																																							
Wide:	----.---m																																																							
Mile.Diff:	----.---m																																																							
	----.---m																																																							
Remark:	-----																																																							
<table border="1" style="width: 100%;"> <tr> <td>MEASURE</td> <td>REC</td> <td>EDM</td> <td>FINISH</td> </tr> </table>			MEASURE	REC	EDM	FINISH																																																		
MEASURE	REC	EDM	FINISH																																																					
TRANSECT MEASURE		2/2																																																						
Stn Mileage:	-----																																																							
North:	-----m																																																							
East:	-----m																																																							
Height:	-----m																																																							
Stake Dist:	20.000m																																																							
Brg:	45° 07' 59' '																																																							
<table border="1" style="width: 100%;"> <tr> <td>MEASURE</td> <td></td> <td>SaveAs</td> </tr> </table>			MEASURE		SaveAs																																																			
MEASURE		SaveAs																																																						

3. Input data and start measurement.

5.2.11.4.3 View Data

It is used to realize data view of peg staking out and transect measurement. All the results can be scanned and deleted but cannot be edited and modified.

To view data, do the following:

1. To enter **ROAD DATA VIEW** display, in **ROAD MENU** display, press **F3 / 3**:

ROAD DATA VIEW					
F1 Peg Data View	(1)				
F2 Transect Data View	(2)				
<table border="1" style="width: 100%; text-align: center;"> <tr> <td>F1</td> <td>F2</td> <td></td> <td></td> </tr> </table>		F1	F2		
F1	F2				

2. Do one of the following:

- To select **Peg Data View**, press **F1 / 1**:

PEG STAKE OUT DATA	1/99			
Mileage:	12.000m ◀▶			
Offset:	10.000m			
North:	25.364m			
East:	32.125m			
Height:	-30.369m			
Remark:	-----			
<table border="1" style="width: 100%;"> <tr> <td>PREV</td> <td>CLEAR</td> <td>DELETE</td> </tr> </table>		PREV	CLEAR	DELETE
PREV	CLEAR	DELETE		

- To select **Transect Data View**, press **F2 / 2**:

PEG STAKE OUT DATA	1/99			
Mileage:	1200m ◀▶			
Wide:	21.201m			
H:	8.785			
<table border="1" style="width: 100%;"> <tr> <td>PREV</td> <td>CLEAR</td> <td>DELETE</td> </tr> </table>		PREV	CLEAR	DELETE
PREV	CLEAR	DELETE		

3. **Optional:** To delete data, do one of the following:

- To delete all results in the current job, press **F2 CLEAR**.
- To delete the current displayed records, press **F4 DELETE**.

5.2.11.4.4 Transfer Data

It is used to upload known data (control point and plane alignment) and download results of staking out and measurement.

During transferring data, please do not power off or do other operations.

To transfer data, do the following:

1. To enter **ROAD DATA TRANSFER** display, in **ROAD MENU** display, press **F4 / 4**:

ROAD DATA TRANSFER

Transfer Type: Download ◀▶

Data Type: Point ◀▶

Swap Mode: No ◀▶

PREV

ENT

- **Transfer Type**
 - Upload: to upload data to total station via PC. It is only appropriate for known data (control point and plane alignment).
 - Download: to send data to PC via total station. It is appropriate for all types of data.
 - **Data Type**: including control point, stakeout results, cross-sectional, and plane alignment.
 - **Swap Mode**
 - No: the same types of existed data will not be deleted.
 - Yes: the same types of all existed data in current job will be deleted.
2. Press **F4 ENT** for confirmation.

5.3 Setting Menu

With this menu, you can achieve the following:

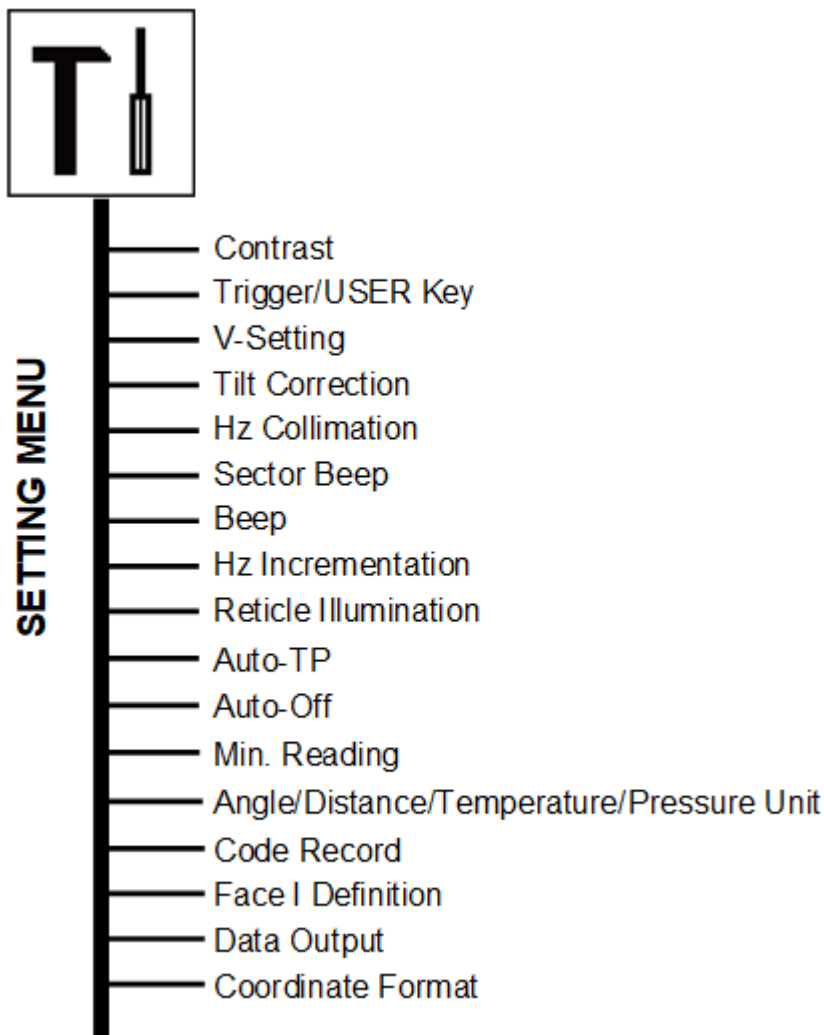

You can set the following in **SETS** menu page by pressing **MENU** and **F2 SETS / 2**:

SETTINGS	1/4
Contrast:	40% ◀▶
Trigger Key:	DIST ▶◀
USER Key:	Offset ▶◀
V-Setting:	Horizon ▶◀
Tilt Cor. :	Off ▶◀
Hz Coll. :	Off ▶◀
	SET

- **Contrast**
It is used to adjust the display contrast.
You can also set it by **Star** key.

- **Trigger key**

It is used to define the side red key as a fixed function:

- **ALL**: to start distance and angle measurements and save measured values.
- **DIST**: to start distance and angle measurements without saving measured values.
- **Off**: to disable trigger key.

- **USER Key**

Each function achieved by function key can be set as **USER** key, which makes **USER** key on the operating panel act as a shortcut key.

- **V-setting**

The **0**- orientation of the vertical circle can be either selected for the following:

- **Zenith**: Zenith = 0° , Horizontal = 90°
- **Horizon**: Zenith = 90° , Horizontal = 0°
- **V-(%)**: $45^\circ=100\%$, Horizontal= 0°

- **Tilt Correction**

- **Off**: to disable the compensator.
- **2-axis**: to make compensation for two axes.
- **1-axis**: to make compensation for a single axis.

You can also set it by **Star** key.

- **Horizontal Collimation**

- **On**: to enable the horizontal collimation.
With it enabled, each measured Hz-angle is corrected (depending on V-angle). Thus, please enable it in general.
- **Off**: to disable the horizontal collimation.

- **Sector Beep**

- **On**: to enable the sector beep.
With it enabled, the sector beep sounds at right angles 0° , 90° , 180° , 270° or 0 gon, 100 gon, 200 gon, 300 gon.
- **Off**: to disable the sector beep.

Example

From 95.0 gon to 99.5 gon (or from 105.0 gon to 100.5 gon), a **Fast beep** sounds while from 99.5 gon to 99.995 gon (or from 100.5 gon to 100.005 gon) a **Permanent beep** sounds:

Permanent beep sounds:

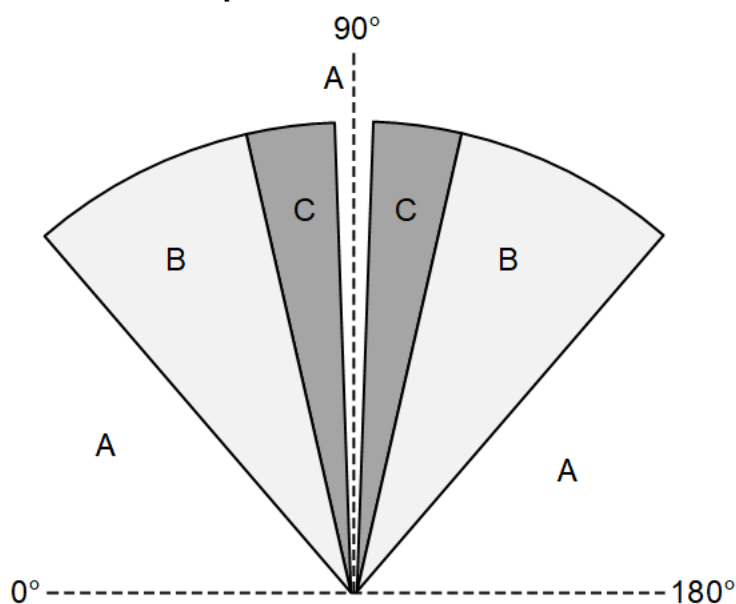

- **A**: no beep
- **B**: fast beep
- **C**: permanent beep

- **Beep**
 - **On:** to enable the beep.
With it enabled, you can hear a sound after pressing each key.
 - **Off:** to disable the beep.
- **Horizontal Incrementation**
 - **Right:** to set right horizontal incrementation for clockwise direction measurement.
 - **Left:** to set left horizontal incrementation for anti-clockwise direction measurement.
- **Reticle Illumination**
 - **On:** to enable reticle illumination.
 - **Off:** to disable reticle illumination.

You can also set it by **Star** key.
- **Auto-TP(Liquid crystal heating)**
 - **On:** to enable LCD heating. It helps normal working under cold conditions.
 - **Off:** to disable LCD heating.
- **Auto-Off**
 - **On:** the instrument is powered off after 20 minutes without any action.
 - **Off:** the instrument is powered on permanently.
This drains the batteries quickly.
- **Min. Reading**

It is used to set the minimum reading of the angle:

 - Angle unit **DMS** (DEGREE, MINUTE, SECOND): 0°00'01" / 0°00'05" / 0°00'10"
 - Angle unit **GON**: 0.0005 gon / 0.001 gon / 0.0001 gon
 - Angle unit **MIL**: 0.01 mil / 0.05 mil / 0.10 mil
 - Angle unit **DEGREE**: 0.0005° / 0.001° / 0.0001°
- **Angle Unit**
 - **DMS (degree sexagesimal):** range: 0° ~ 359°59'59"
 - **GON:** range: 0 gon ~ 399.999 gon
 - **MIL:** range: 0 mil ~ 6399.99 mil
 - **DEGREE(degree decimal):** range: 0° ~ 359.999°

The setting can be changed at any time, and will immediately take effective.
- **Distance Unit**
 - **Meter**
 - **US-ft:** US-feet
 - **INT-ft:** international feet
 - **ft-in1/16:** US-feet-Inch-1/16 inch
- **Temperature Unit**
 - **°C:** degree Celsius
 - **°F:** degree Fahrenheit
- **Pressure Unit**
 - **hPa:** Hecto Pascal
 - **mbar:** Millibar
 - **mmHg:** Millimeter mercury column
 - **inHg:** Inch mercury column
- **Code Record**
 - **RecBefore:** codeblock is saved before the measurement.
 - **RecAfter:** codeblock is saved after the measurement.

- **Face I Definition**
 - **Face_I:** I means face left, and II means face right.
 - **Face_II:** I means face right, and II means face left.
- **Data Output**
 - **Intern:** all data is recorded in the internal memory.
 - **RS232:** data is recorded via the serial interface. For this purpose, a data storage device must be connected.
- **Coordinate Format**
 - **NEH**
 - **ENH**

5.4 EDM Menu

With this menu, you can achieve the following:

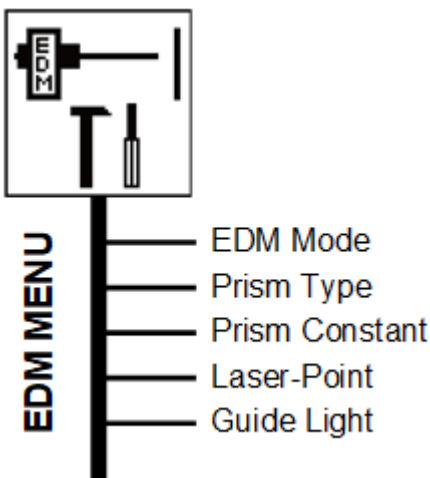

5.4.1 Common Parameters

You can set common parameters by pressing **MENU** and **F3 EDM / 3** to select EDM menu:

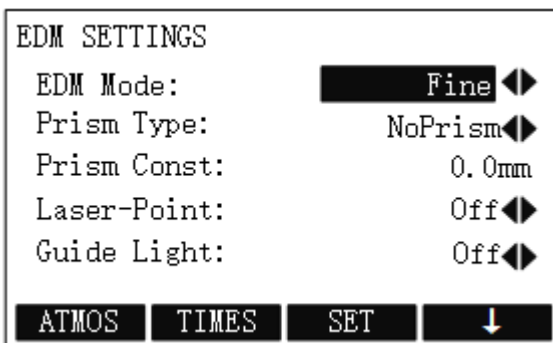

- **EDM Mode:**
 - **Quick:** quick measuring mode with higher measuring speed and less accuracy.
 - **Track:** continuous distance measuring.
 - **Fine:** fine measuring mode with high accuracy.

Note: The prism type is different in different mode.

- **Prism Type and Prism Contrast**

- When a prism is used, the selection includes:

Prism Type	Prism Constant
Circle prism	0
MINI	17.2
JPMINI	34.4
360°	23.1
360°Mini	30
User define	Self-adjustment (Range: -999.9mm ~ +999.9mm)

- When a sheet is used, the prism type includes:
 - Sheet
 - User define
- When no prism is used, the prism type includes:
 - No prism
 - User define

- **Laser-Point**

It is used to enable / disable laser point.

- **Guide Light**

This is useful during staking out points. The person at the prism can be directly guided by the flashing lights to the line of sight. The light points are visible up to a distance of 150 meters.

5.4.2 Atmospheric Parameters

Atmospheric parameters are used to correct the influences in distance measuring caused by the atmospheric conditions of the air.

You can set atmospheric parameters by pressing **MENU** and **F3 EDM / 3** to select **EDM** menu, and pressing **F1 ATMOS** in **EDM SETTINS** display:

ATOMOSPHERIC DATA (PPM)	
Ht. a. MSL:	0m
Temperature:	15.0° C
Pressure:	1013.2 H _p A
Atmos PPM:	0.0PPM
Refract:	0.10
Humidity:	0%
PREV	PPM=0
	SET

- **Ht. a. MSL:** the height above the sea level at the instrument location.
- **Temperature:** the air temperature at the instrument location.
- **Pressure:** the air pressure at the instrument location.
- **Atmos PPM:** the atmospheric PPM.
- **Refract:** the refraction coefficient for the atmospheric conditions, which is taken into account in the calculation of the height differences and the horizontal distance.
- **Humidity:** the atmospheric humidity.

5.4.3 Times of Distance Measuring

You can set the times of distance measuring by pressing **MENU** and **F3 EDM / 3** to select **EDM** menu, and pressing **F2 TIMES** in **EDM SETTINS** display:

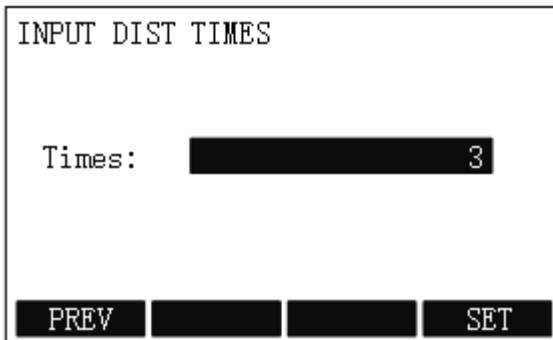

5.4.4 Projection Scale

You can set the scale of projection by pressing **MENU** and **F3 EDM / 3** to select **EDM** menu, and pressing **F4 ↓ → F1 SCALE** in **EDM SETTINS** display:

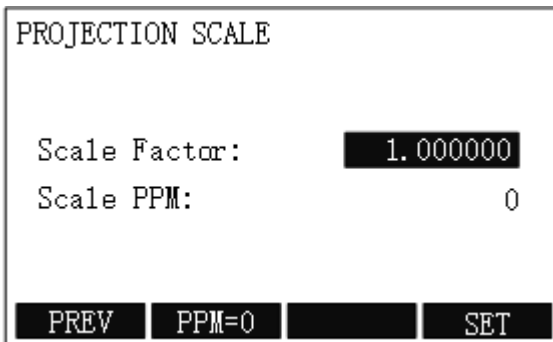

- **Scale Factor:** the scale of projection. Measured values and coordinates are corrected with the PPM parameter. Range: 0.50 ~ 1.999999.
- **Scale PPM:** it automatically changes with the value of **Scale Factor**.
- **PPM=0:** to set the scale factor and scale PPM to default values.

5.4.5 Signal Intensity

It is used to check the EDM signal intensity (reflection intensity), which permits optimal aiming at distant barely visible targets.

You can check the signal intensity by pressing **MENU** and **F3 EDM / 3** to select **EDM** menu, and pressing **F4 ↓ → F2 SIGNAL** in **EDM SETTINS** display:

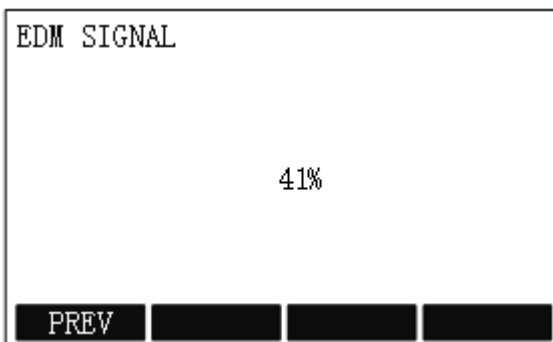

5.5 Job Menu

This menu contains all functions for entering, editing and checking data in the field.

With this menu, you can achieve the following:

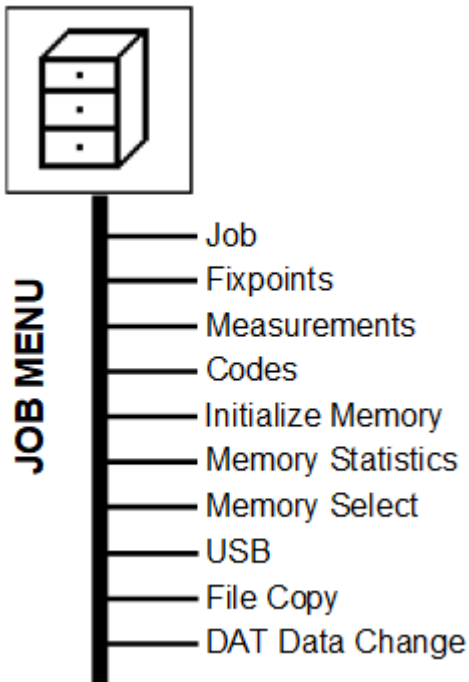

5.5.1 Job

Jobs are a summary of data of different types, e.g. fixed points, measurements, codes, results, etc. Each job consists of job name, operator, note 1 and note 2. You can view and delete created jobs, and create a new job.

You can enter **VIEW JOB** display by pressing **MENU** and **F4 JOB / 4**, and pressing **F1 / 1** in **FILE MANAGEMENT** display:

VIEW JOB	1/23
Job :	DEFAULT ◀▶
Operator :	-----
Note 1 :	-----
Note 2 :	-----
DELETE	ADD ENT

In this display, you can achieve the following:

- View created jobs by pressing ◀ / ▶ to switch among created jobs.
- Delete the selected job by pressing **F1**.
- Start a new job by pressing **F3**.
- Set the selected job by pressing **F4**.

5.5.2 Fixed points

Valid fixed points contain at least PtID and coordinates (East, North) or (Height).

You can enter **VIEW FIXPOINTS** display by pressing **MENU** and **F4 JOB / 4**, and pressing **F2 / 2** in **FILE MANAGEMENT** display:

VIEW FIXPOINTS	1/8
Job :	TEST ◀▶
PtID:	6 ◀▶
North:	7.000m
East:	8.000m
Height:	9.000m
FIND	DELETE ADD EDIT

In this display, you can achieve the following:

- Start point search by pressing **F1 FIND**.
You can input the exact PtID, or use * wildcard criteria.
- Delete the selected fixed point by pressing **F2 DELETE**.
- Add a new fixed point by pressing **F3 ADD**.
- Edit the known data by pressing **F4 EDIT**.

5.5.3 Measurements

Measurement data stored in the internal memory can be searched, displayed and erased.

You can enter **VIEW MEASURE DATA** display by pressing **MENU** and **F4 JOB / 4**, and pressing **F3 / 3** in **FILE MANAGEMENT** display:

VIEW MEASURE DATA
Job : TEST ◀▶
Station : *
F3 Search Define Point
F4 View All Measure Data
PT VIEW

In this display, you can achieve the following:

- Start point search by pressing **F3 PT**.
- View all measurement data by pressing **F4 VIEW**.

5.5.4 Codes

It is used to create a new code, and edit / delete the selected code.

You can enter **CODE VIEW / DELETE** display by pressing **MENU** and **F4 JOB / 4**, and pressing **F4 / 4** in **FILE MANAGEMENT** display:

CODE VIEW/DELETE				
Search:	*			
Code:	6 ◀▶			
Q-Code:	TEST			
Desc:	TEST			
Info1:	TEST			
Info2:	TEST			
<table border="1"> <tr> <td>NEW</td> <td>EDIT</td> <td>DELETE</td> </tr> </table>		NEW	EDIT	DELETE
NEW	EDIT	DELETE		

In this display, you can achieve the following:

- Create a new code by pressing **F1 NEW**.
- Edit the selected code by pressing **F2 EDIT**.
- Delete the selected code by pressing **F4 DELETE**.

5.5.5 Initialize Memory

It is used to delete all data or the selected data (job, measure or known point) for memory releasing according to the selected data type.

You can enter **INITIALIZE MEMORY** display by pressing by pressing **MENU** and **F4 JOB / 4** and pressing **PAGE** to go to the second page, and pressing **F1 / 5** in **FILE MANAGEMENT** display:

INITIALIZE MEMORY			
Job:	12 ◀▶		
Data:	Known Point ◀▶		
<table border="1"> <tr> <td>ALL</td> <td>DELETE</td> </tr> </table>		ALL	DELETE
ALL	DELETE		

In this display, you can achieve the following:

- Delete all data by pressing **F1 ALL**.
- Delete the selected data by pressing **F2 DELETE**.

 **Note:** The operation is irreversible. Please do it carefully.

5.5.6 Memory Statistics

You can enter **MEMORY INFORMATION** display by pressing **MENU** and **F4 JOB / 4**, and pressing **PAGE** to go to the second page and pressing **F2 / 6** in **FILE MANAGEMENT** display:

MEMORY INFORMATION	
Job :	DEFAULT ◀▶
STN Num:	14
Known Point:	8
Measure Data:	127
Spare Job:	2
ENT	

In this display, you can check the following information:

- **STN Num:** the number of stations.
- **Known Point:** the number of stored known points.
- **Measure Data:** the number of recorded data blocks (measured points, codes, etc.).
- **Spare Job:** the number of free or not defined jobs.

5.5.7 Memory Selection

It is used to select the memory source.

You can enter **MEMORY INFORMATION** display by pressing **MENU** and **F4 JOB / 4**, and pressing **PAGE** to go to the second page, and pressing **F3 / 7** in **FILE MANAGEMENT** display:

MEMORY SELECT	
<input checked="" type="radio"/>	F1 Inside SD
<input type="radio"/>	F2 Extern SD
F1	F2
PREV	SET

- Select memory source from the inside SD by pressing **F1**.
- Select memory source from the external SD by pressing **F2**.

5.5.8 USB

It is used to send and select data from a flash disk.

Please plug a flash disk into the USB interface firstly. Otherwise, the following display shows:

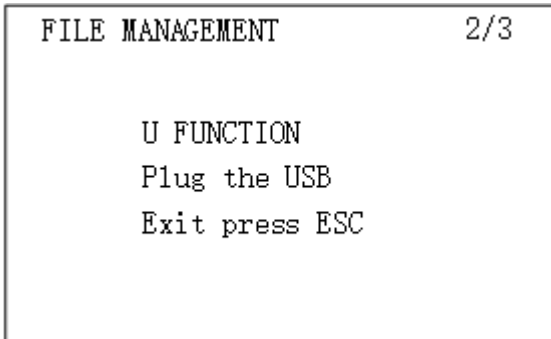

5.5.9 File Copy

You can enter **MSD Copy to SD** display by pressing **MENU** and **F4 JOB / 4**, and pressing **PAGE** to go to the third page, and pressing **F1 / 9** in **FILE MANAGEMENT** display:

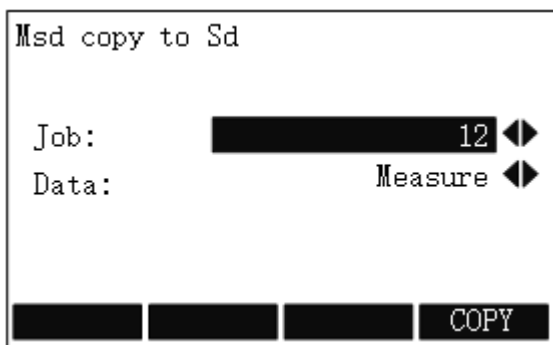

5.5.10 DAT Data Change

You can enter **DAT Data Change** display by pressing **MENU** and **F4 JOB / 4**, and pressing **PAGE** to go to the third page and pressing **F2 / 01** in **FILE MANAGEMENT** display:

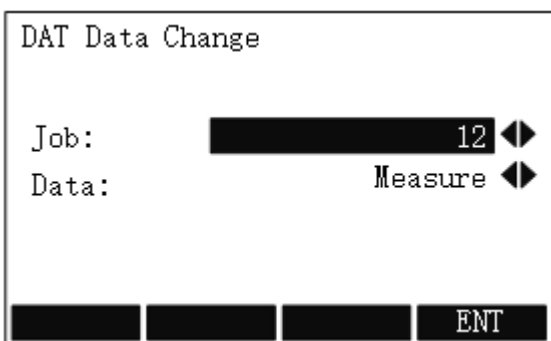

5.6 Adjust Menu

With this menu, you can achieve the following:

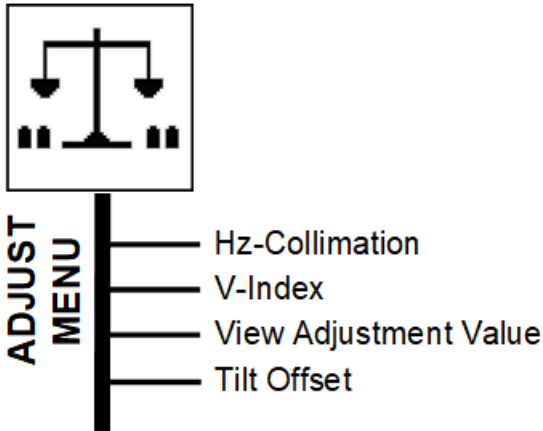

5.6.1 Horizontal Collimation

If the sight line of the telescope is not perpendicular to the horizontal axis, the collimation error will appear. Besides, the assembling, transportation and operation will also cause this error.

The whole process is as follows:

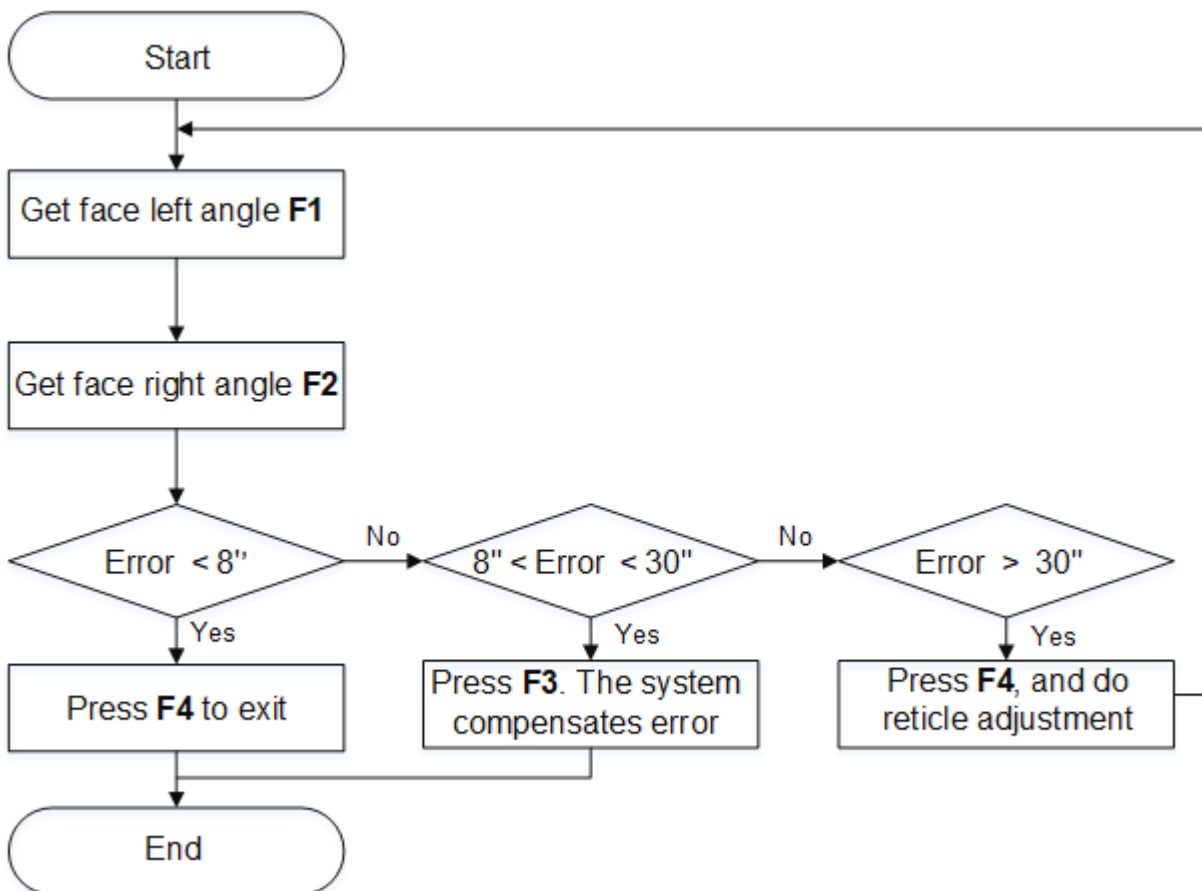

Before adjusting the horizontal collimation error, do the following:

- Set up the Instrument
- Do Levelling-up

To adjust the horizontal collimation error, do the following:

1. To select **HZ-Collimation**, Press **MENU**, press **PAGE** to go to the second page, press **F1 ADJ / 5**, and press **F1 / 1** in **CHECK & ADJUST** display:

HZ-COLLIMATION	
Hz :	0° 00' 00''
V :	90° 00' 02''
Take F1	
ENT	

2. To get the face left angle reading **F1**, aim at the cross-hairs of collimator or the obvious target at a distance at telescope left, and press **F3 ENT**:

HZ-COLLIMATION	
Hz :	180° 00' 03''
V :	280° 00' 05''
Take F2	
ENT	

3. To get the face right angle reading **F2**, aim at the cross-hairs of collimator or the obvious target at a distance at telescope right, and press **F3 ENT**. The system automatically calculates the new collimation error:

HZ-COLLIMATION	
V-Index	
Old X :	0° 00' 00''
New X :	- 0° 00' 04''
Set?	
YES NO	

4. Judge if the error is within allowable range:

 **Note:** You can calculate the horizontal collimation error by formula $(F1 - F2 \pm 180^\circ) / 2$.

- If the error is less than 8", press **F4 NO** to exit.
- If the error is greater than 8" but less than 30", press **F3 YES** to view calibration data:

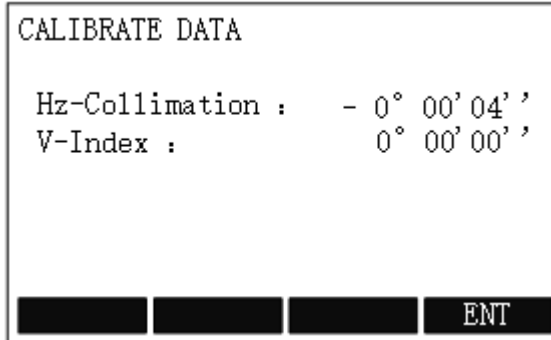

- If the error is greater than 30", press **F4 NO** to exit and do reticle adjustment:
 - i. Rotate the instrument at telescope right, and turn the horizontal tangent screw until $F2' = F2 + C$.
 - ii. Loosen the shield of the reticle of the telescope:
 - iii. Do the following to adjust the screws of reticle until the vertical hairs of telescope's reticle coincides with the cross-hairs of collimator or target:

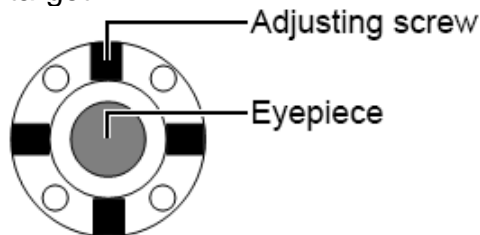

1. Loosen the screw on the moving direction of reticle. Anticlockwise turning is for loosening, and clockwise turning is for tightening.
 2. Tighten another screw by the same mount.
- iv. Repeat the whole adjustment process of the horizontal collimation error until the error is less than 30".

5.6.2 Vertical Index

The deviation between vertical circle zero position and horizontal direction is vertical index. It is necessary to concern this error when measuring vertical angle.

Because of the close relationship between vertical index and compensator zero position, it is necessary to check and adjust compensator zero position when adjusting the vertical circle, to keep the value stable when reading.

The whole process is as follows:

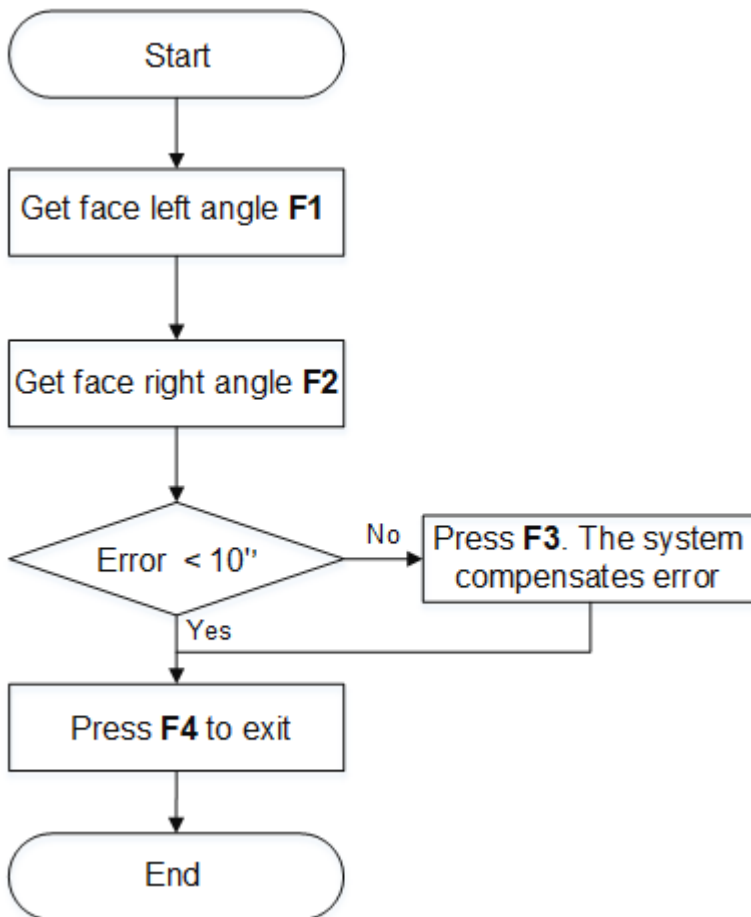

Before adjusting the vertical index error, make sure the horizontal collimation error has been adjusted.

To adjust the vertical index error, do the following:

1. To select **V-Index**, press **MENU**, press **PAGE** to go to the second page, press **F1 ADJ / 5**, and press **F2 / 2** in **CHECK & ADJUST** display:

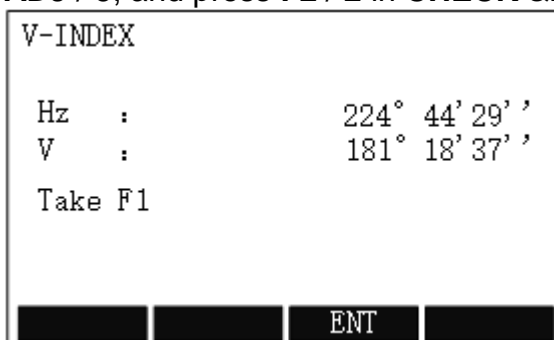

2. To get the face left angle reading **F1**, aim at the cross-hairs of collimator or the obvious target at a distance at telescope left, and press **F3 ENT**:

```

V-INDEXX
Hz      :          41° 59' 53' '
V       :          269° 15' 08' '
Take F2
    
```

ENT

3. To get the face right angle reading **F2**, aim at the cross-hairs of collimator or the obvious target at a distance at telescope right, and press **F3 ENT**. The system automatically calculates the new error:

```

V-INDEXX
V-Index
Old X   :          0° 00' 00' '
New X   :         - 0° 00' 08' '
Set?
    
```

YES NO

4. Press **F3 YES** to view calibration data:

```

CALIBRATE DATA

Hz-Collimation :   - 0° 00' 04' '
V-Index       :    0° 00' 00' '
    
```

ENT

5. Judge if the error is within allowable range:

 **Note:** You can calculate the vertical index error by formula $(F1 + F2 - 360^\circ) / 2$.

- If the error is less than 10", press **F4 NO** to exit.
- If the error is greater than 10", press **F3 YES** to view calibration data.

5.6.3 View Adjustment Value

To view adjustment value, do the following:

1. To select **View Adjustment Value**, Press **MENU**, press **PAGE** to go to the second page, press **F1 ADJ / 5**, and press **F3 / 3** in **CHECK & ADJUST** display:

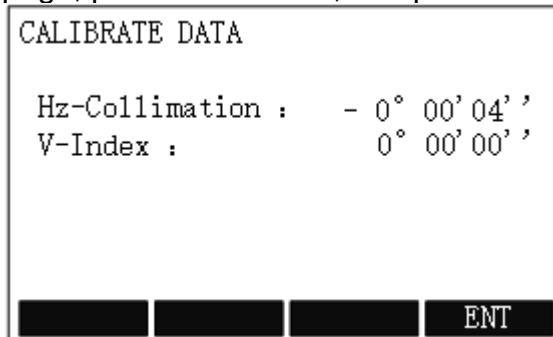

2. Check the value of horizontal collimation and vertical index.

5.6.4 Tilt Offset

The whole process is as follows:

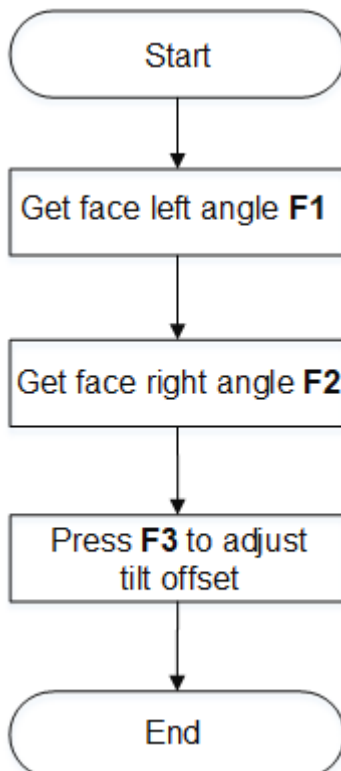

To adjust the tilt offset, do the following:

1. To select **Tilt Offset**, press **MENU**, press **PAGE** to go to the second page, press **F1 ADJ / 5**, and press **F4 / 4** in **CHECK & ADJUST** display:

```

TILT OFFSET

X   :          - 0° 00' 18" '
Y   :           0° 00' 06" '

Take F1

[ ] [ ] [ ENT ] [ ]
    
```

2. To get the face left angle reading **F1**, aim at the cross-hairs of collimator or the obvious target at a distance at telescope left, and press **F3 ENT**:

```

TILT OFFSET

X   :          - 0° 00' 18" '
Y   :           0° 00' 06" '

Take F1

[ ] [ ] [ ENT ] [ ]
    
```

3. To get the face right angle reading **F2**, aim at the cross-hairs of collimator or the obvious target at a distance at telescope right, and press **F3 ENT**. The system automatically calculates the new collimation error:

```

TILT OFFSET

Old X :           0° 00' 00" '
New X :           0° 00' 06" '
Old X :           0° 00' 00" '
New X :          - 0° 00' 03" '

Set?

[ ] [ ] [ YES ] [ NO ]
    
```

4. Press **F3 YES** for confirmation.

5.7 Com Menu

To achieve data transfer between PC and the instrument, the communication parameters of RS232 serial interface must be set.

With this menu, you can achieve the following:

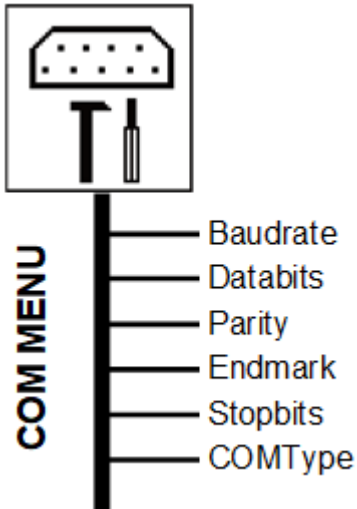

You can set communication parameters by pressing **MENU**, pressing **PAGE** to go to the second page, and pressing **F2 COM / 6**:

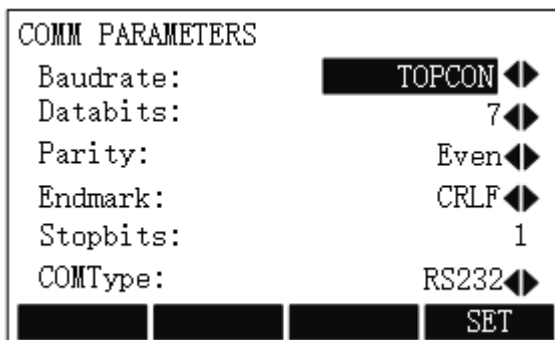

- **Baudrate**
 - Data transfer speed: 1200 / 2400 / 4800 / 9600 / 19200 / TOPCON / SOKKIA
 - Unit: bits / second
- **Databits**
 - **7**: data transfer is realized with 7 databits. It is automatically set if **Parity** is set to **Even** or **Odd**.
 - **8**: data transfer is realized with 8 databits. It is automatically set if **Parity** is set to **None**.
- **Parity**
 - **Even**: even parity.
 - **Odd**: odd parity.
 - **None**: no parity if **Databits** is set to **8**.
- **Endmark**
 - **CRLF**: carriage return; line feed.
 - **CR**: carriage return.
- **Stopbits**
 - Its fixed setting is **1**.

- **COMType**
 - **RS232**
 - **BLUETOOTH**: when it is set to this type, symbol  shows in the display.

5.8 Download Menu

With the help of this function measured data can be transferred via the serial interface to a receiver (e.g. a laptop).

With this menu, you can achieve the following:

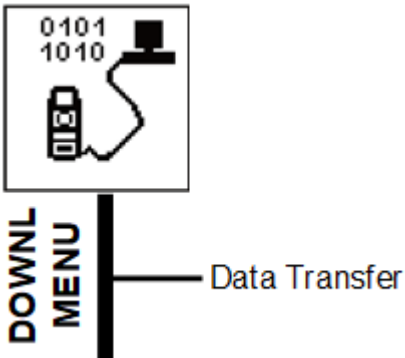

To transfer data, do the following:

1. To enter **DATA TRANSFER** display, press **MENU**, press **PAGE** to go to the second page, and press **F3 DOWNL / 7**:

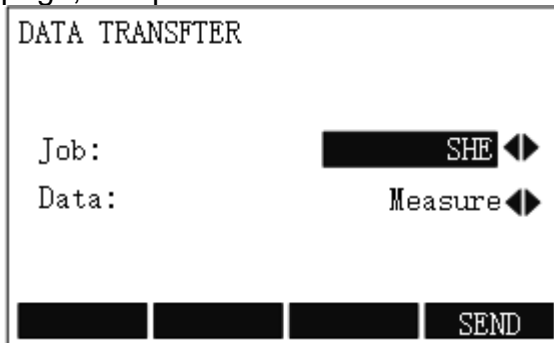

2. To select the job from which data should be transferred, press **◀ / ▶** after **Job**.
3. To Select the data range to be transferred (measurements or fixed points), press **◀ / ▶** after **Data**.
4. To start transmission, press **F4 SEND**.

5.9 Start Menu

It is used to set the start-up sequence.

With this menu, you can achieve the following:

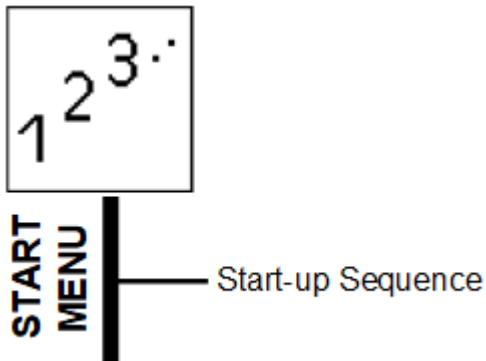

To set the start-up sequence, do the following:

1. To enter **START-UP SEQUENCE** display, press **MENU**, press **PAGE** to go to the second page, and press **F4 START / 8**:

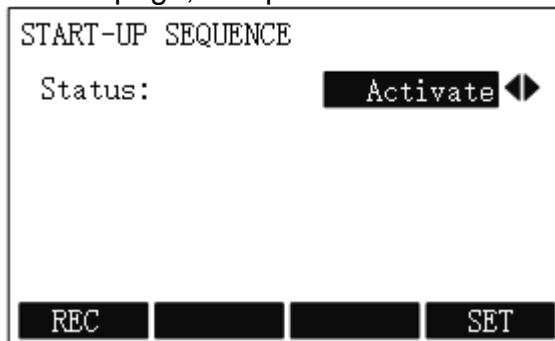

2. Select the status.
3. To give the definition that start-up sequence will be executed automatically on triggering the key, press **F1 REC**.
4. To store the current settings, press **F4 SET**.

5.10 Info Menu

It is used to check battery, instrument temperature, and data of the system.

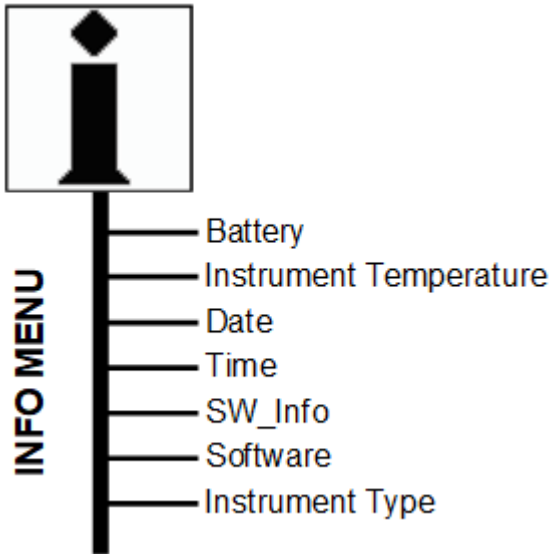

To check the system information, do the following:

1. To enter **SYSTEM INFO** display, press **MENU**, press **PAGE** to go to the third page, and press **F1 INFO / 9**:

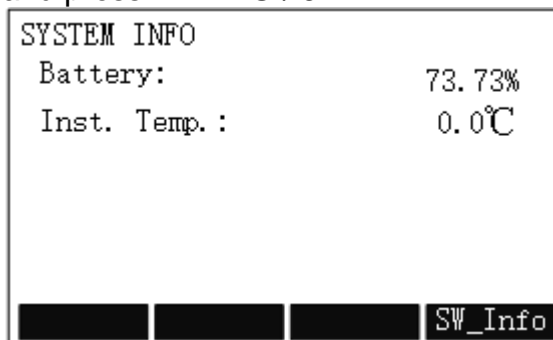

2. Check the remaining battery power and measured instrument temperature.
3. **Optional:** To check the software information, press **F4 SW_INFO**, and check the software version, instrument type and instrument No.:

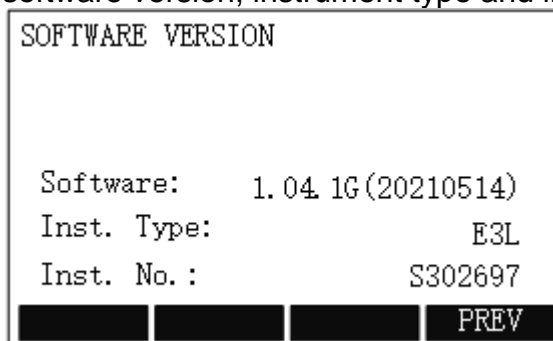

6 Maintenance

6.1 Cleaning and Drying

About cleaning and drying, please note the following:

- Please wipe up the painted surface.
- Please blow dust off lenses.
- Please use only a clean degreasing cotton for cleaning up. If necessary, please moisten the cotton with little pure alcohol. And please do not use other liquids (oil, gasoline, water, etc.) which may attack the polymer components.
- Please never touch the glass with your fingers.
- Please be careful to wipe damp instrument. Please take out the instrument from case and make it completely dry. And do not store the instrument in case. Besides, please keep the case clean inside and outside, and keep it dry.

6.2 Storage

About storage, please note the following:

- When the instrument is stored for a long term, please take it out from case in order to allow the air to circulate and avoid lens's mildew.
- Storage must be under the conditions of dust prevention, air circulation and low humidity. Thus, please use desiccator and fuming cupboard in wet areas, and do not move the instrument indoors during the period of not using it in cold regions. And please keep it in safe places under ambient temperature, which can prevent water vapour from condensing on optical glasses and inside the instrument.

6.3 Transportation

About transportation, please put the instrument into the case which includes foam inserts or other shockproof stuff for long-distance transportation.

6.4 Check

About check, please regularly check the instrument, and adjust it according to instruction manual if necessary.

7 Check and Correction

7.1 Instrument Constant

Before delivery, the distance plus constant of the instrument has been calibrated to zero. Considering the distance plus constant may change, it shall, if possible, be subject to regular precise measurement based on the existing baseline, or if impossible, be measured by using the following method:



Note: Both centering error and collimation error of the instrument and prism may affect the measurement result of distance plus constant, and thus special care should be taken to reduce these errors during inspection. Besides, it is also required to make the instrument and prism of equal height, and a level should be used to measure the instrument height and the prism height when detection is performed on uneven ground.

1. Select two points A and B on the flat ground that are about 100m away from each other, respectively set the instrument and a prism at points A and B, and select a point C between points A and B:

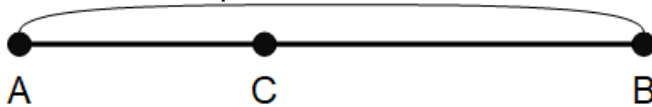

2. Precisely measure the horizontal distance between A and B for 10 times, and calculate the average value.
3. Move the instrument to C, and set prisms at points A and B:

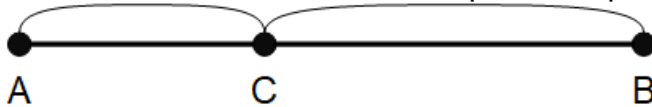

4. Precisely measure the horizontal distance between C and A and between C and B for 10 times, and respectively calculate average values.
5. Calculate the distance plus constant according to the following formula:

$$K = AB - (CA + CB)$$
6. Repeat step 1 ~ 5 to measure the distance plus constant for two to three times:
 - If the results always fall within ± 3 mm, no correction is required.
 - If not, correction is required.
 At this time, please contact us.

7.2 Tubular Level

To do checking and correction for the tubular level, do the following:

1. Place the instrument on a stable device (such as a tripod or instrument calibration table), and fix it.
2. Do basic levelling-up.
3. Make the tubular level parallel to a line connecting two of the three foot screws on the base, and adjust the two foot screws to set the bubble of the tubular level at the center.
See [3.3 Do Levelling-up](#) for details.
4. Rotate the instrument 180°, and observe if the bubble is at the center of the tubular level:
 - If it is, no correction is required.
 - If not, proceed to step **5 ~ 6**.
5. When the bubble gets stable, make fine adjustment of the screws by using a calibration pin, driving the bubble to move half distance toward the center of the tubular level.
6. Repeat step **3 ~ 5** until the bubble can remain at the center of the tubular level when the tubular level rotates to any position after accurate levelling-up.

7.3 Circular Level

To do checking and correction for the circular level, do the following:

1. Place and fix the instrument onto a stable device.
2. Use the tubular for accurate levelling-up of the instrument.
See [3.3.2.1 Do Accurate Levelling-up with the Tubular Level](#) for details.
3. Observe if the circular level bubble is centered.
 - If it is, no correction is required.
 - If not, proceed to step **4**.
4. Adjust the three correction screws by using an Allen wrench to make the bubble at the center of the circular level:

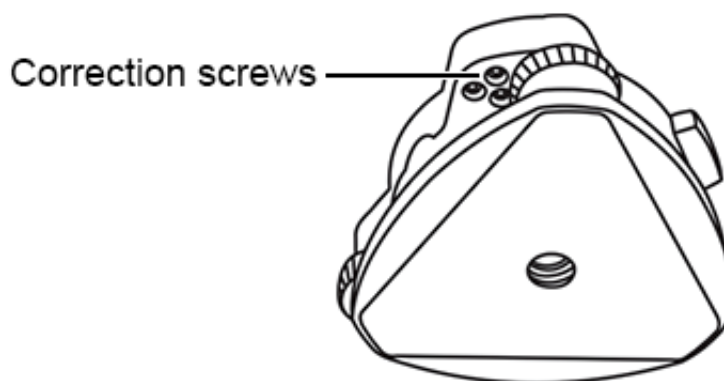

7.4 Optical Sight of the Telescope

To do checking and correction for the optical sight of the telescope, do the following:

1. Put the instrument on a tripod and fix it.
2. Set a cross mark target 50 m away from the instrument.
3. Collimate the telescope of the instrument to the cross mark target.
4. Observe if the optical sight collimates the cross mark target:

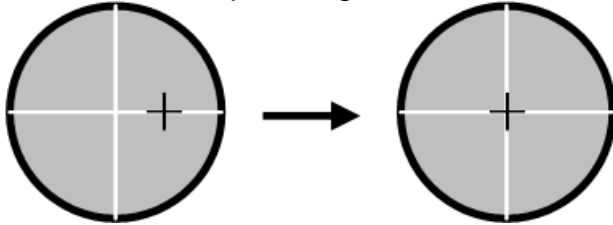

- If it does, no correction is required.
 - If not, proceed to step 5.
5. Loosen the 2 screws fixing the optical sight, adjust the device to a proper position, and then tighten the 2 screws:

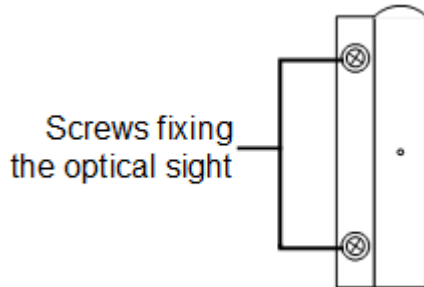

7.5 Laser Centering Device

To do checking and correction for the laser centering device, do the following:

1. Set the instrument on a tripod and fix it.
2. Put a cross mark target directly below the instrument.
3. Turn the three foot screws on the instrument base to make the laser point overlap with the cross mark target on the ground.
4. Rotate the instrument 180°, and observe if the laser point overlaps with the cross mark target on the ground:

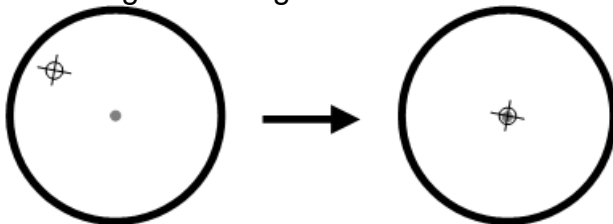

- If it does, no correction is required.
 - If not, proceed to step 5 ~ 11.
5. Remove the instrument from the tribrach.
See [8.3 Assembling and Disassembling for the Three-jaw Tribrach](#) for details.
 6. Turn screws on the protection cover at the bottom of the instrument counterclockwise, and remove the protective cover.
 7. Remount the instrument onto the tribrach.
 8. Fix the instrument on the tripod, and place a cross mark target right below it.

9. Turn the three foot screws on the instrument base to make the laser point overlap with the cross mark target on the ground.
10. Horizontally rotate the instrument 180°, make fine adjustment of two screws by using a calibration pin, moving the cross mark target on the ground half distance toward the laser point.
There are totally three screws, and the one shown in the following figure may not be adjusted by using a calibration pin:

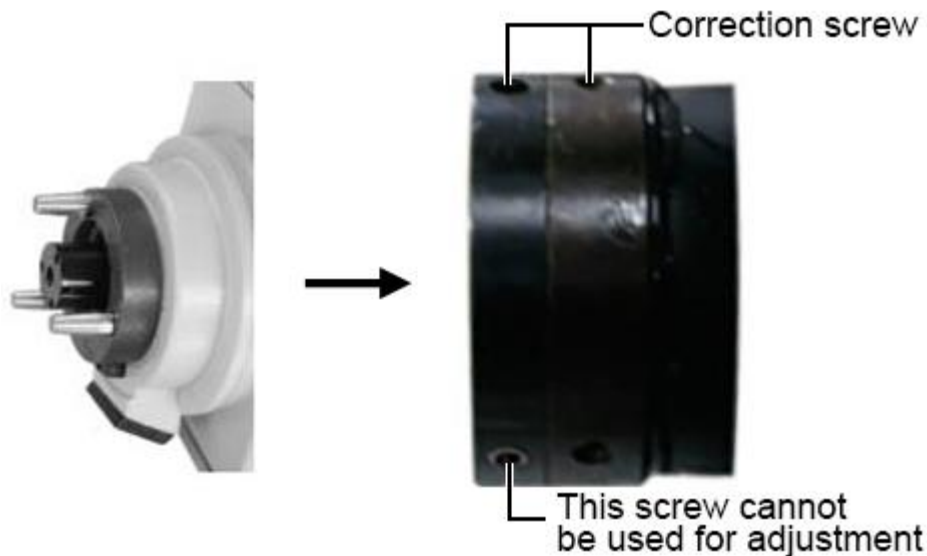

11. Repeat step 9 and 10 until the cross mark target on the ground always overlaps with the laser point when the instrument is turned to any direction.

7.6 Vertical Line of the Telescope Reticle

If the vertical line of the reticle is not perpendicular to the horizontal axis of the telescope, correction is required (because one point on the vertical line may be used to collimate the target for horizontal angle measurement or for vertical staking).

To do checking and correction for the vertical line of the telescope reticle, do the following:

1. Set the instrument on a tripod and precisely level it.
2. Set a point A at 50 m away from the instrument.
3. Collimate the telescope of the instrument to point A, turn the vertical inching hand wheel, and observe if point A moves along the vertical line of the reticle:
 - If it does, no correction is required.
 - If not, proceed to the next step.
4. Turn the protective cover of the reticle counterclockwise, and remove the cover to expose the four screws fixing the eyepiece.
5. Use a cross screwdriver to slightly loosen the four screws fixing the reticle.

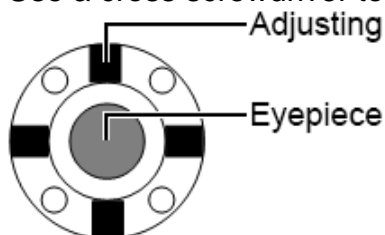

6. Turn the eyepiece end until the vertical line of the reticle overlaps with point A:

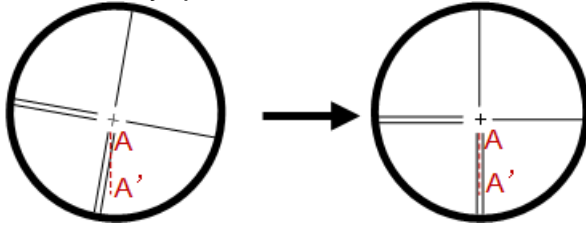

7. Tighten the four screws fixing the reticle.

8. Repeat calibration until point A always moves along the vertical line of the reticle.

After doing correction for the vertical line of the telescope reticle, check the collimation error and index error of the instrument.

See [5.6.1 Horizontal Collimation](#) and [5.6.2 Vertical Index](#) for details.

7.7 Collimation Error of the Instrument

See [5.6.1 Horizontal Collimation](#) for details.

7.8 Index Error of the Vertical Circle

See [5.6.2 Vertical Index](#) for details.

7.9 Zero Position Error of the Tilt Offset

See [5.6.4 Tilt Offset](#) for details.

7.10 Optical Axis and Telescope Sighting Axis for Distance Measurement

It is used to check optical axes of the rangefinder and theodolite for consistency.

Before doing checking and correction for the optical axis and telescope sighting axis for distance measurement, make sure correction of the eyepiece reticle has been done.

To do checking and correction for the optical axis and telescope sighting axis for distance measurement, do the following:

1. Place the instrument on a stable device or a tripod, precisely level it and turn it on.
2. Attach the reflector plate supplied along at 5 m ~ 20 m away from the instrument.
3. Collimate the reflector plate, and align the reticle with that on the reflector plate.
4. Set the instrument to the signal test mode.
5. Observe if the laser point hits on the reticle:
 - If it does, no correction is required.
 - If not, contact us.

8 Appendix

8.1 Atmospheric Correction Formula and Chart (Just for reference)

The related information is as follows:

- Factory setting: temperature: 20°C, pressure:1013 hpa, 0 ppm
- Correction: $K_{pt} = 274.417 - 0.2904 * p / (1 + 0.0036 * t)$

Where:

- K_{pt} : atmospheric correction (ppm)
- p : pressure value (hPa)
- t : temperature value (°C)

Example:

If $t=20^{\circ}\text{C}$, $p=1013\text{hpa}$, $L_0=1000\text{m}$, then:

- $K_{pt} = 0\text{ppm}$
- $L = L_0 (1 + K_{pt}) = 1000 * (1 + 0 * 10^{-6}) = 1000.000\text{m}$

The atmospheric value is obtained easily with the following atmospheric correction chart:

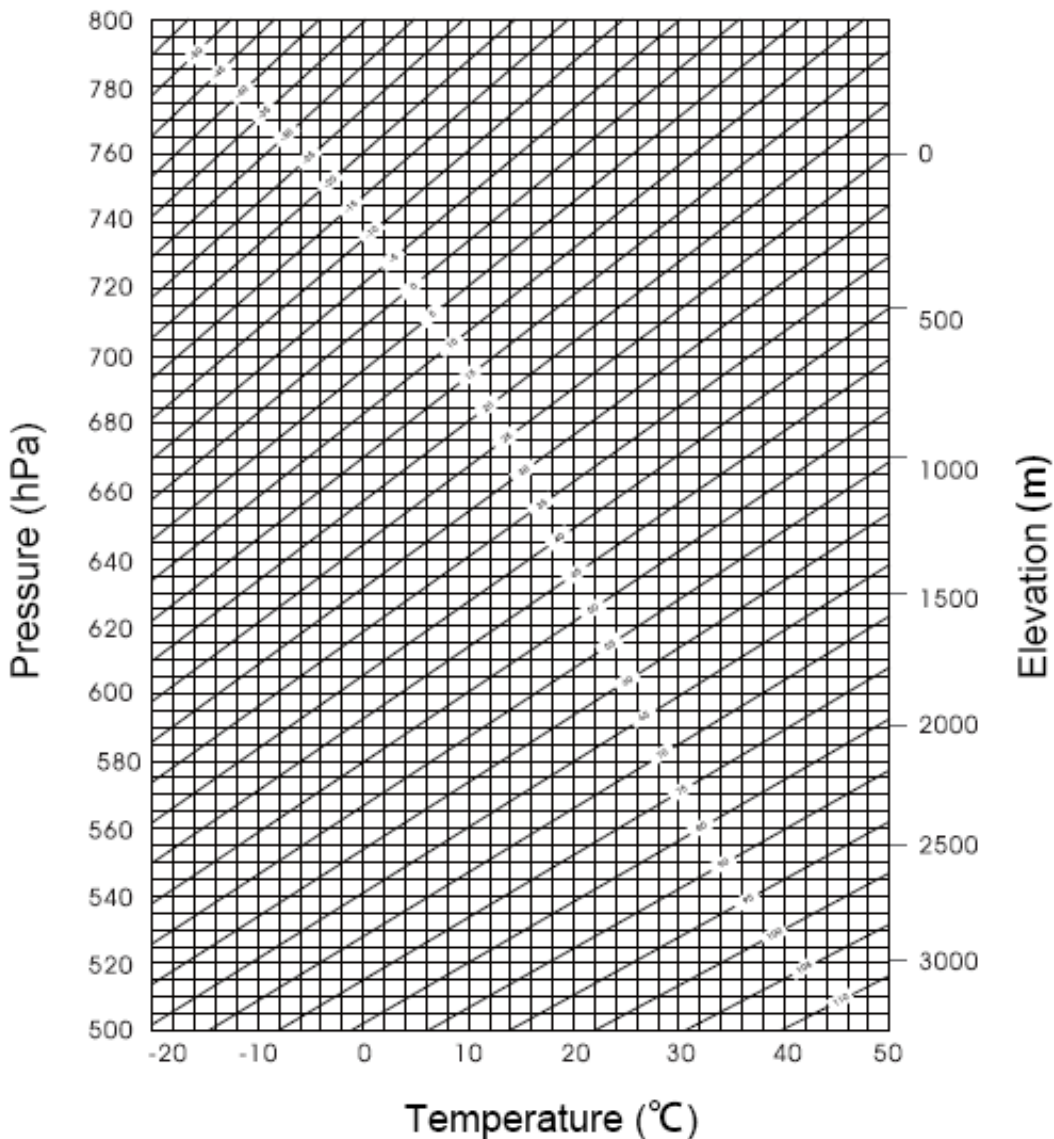

- Horizontal axis: the measured temperature.
- Vertical axis: the pressure.
- Diagonal line: the required atmospheric correction value.

8.2 Correction for Refraction and Earth Curvature

Considering the correction of refraction and earth curvature for distance measurement, the formula for slope distance, horizontal distance and vertical distance applied in the instrument are as followings:

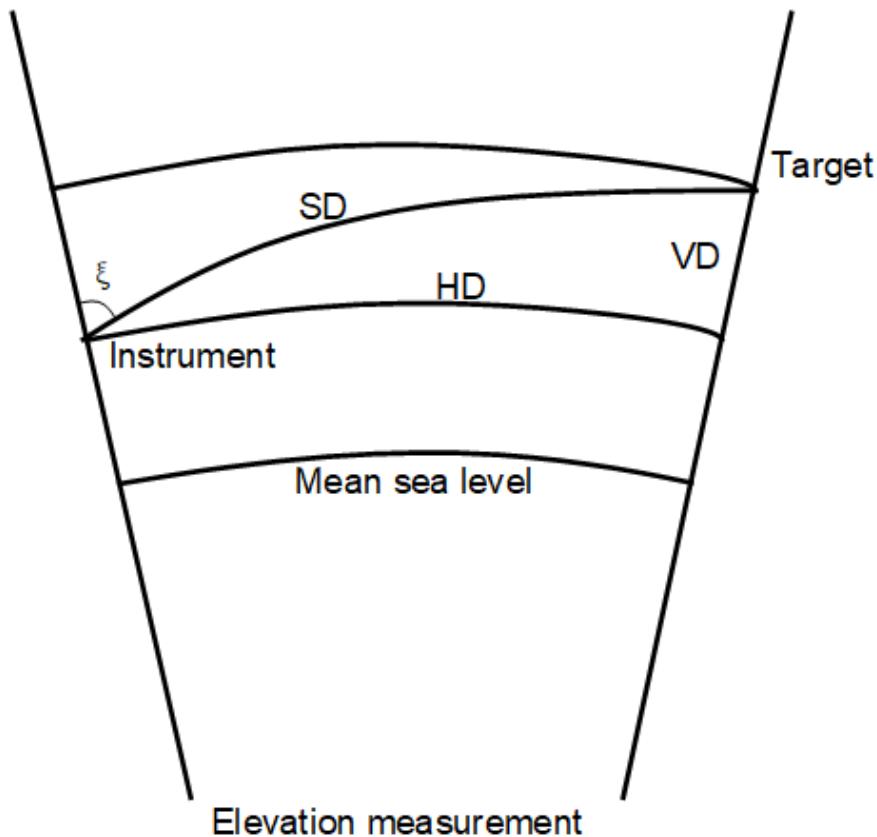

- $SD = D_o * (1 + ppm * 10^{-6}) + mm$
 - SD: displayed slope distance (m)
 - D_o : real measured distance (m)
 - ppm: scale coefficient (mm/km)
 - mm: target constant (mm)
- $HD = Y - A * X * Y$; $VD = X + B * Y^2$
 - HD: horizontal distance (mm)
 - VD: vertical distance (mm)
 - Y: $SD * |\sin|\xi$ (ξ : zenith angle)
 - X: $SD * \cos\xi$ (ξ : zenith angle)
 - A: $(1 - K / 2) / R$ ($K = 0.142$ or 0.20 ; $R = 6.37 * 10^6$) (m)
 - B: $(1 - K / 2) / 2R$ ($K = 0.142$ or 0.20 ; $R = 6.37 * 10^6$) (m)

The conversion formula for horizontal and vertical distance is as follows when correction for refraction and earth curvature is not applied:

- $HD = SD * \cos\xi$
- $VD = SD * |\sin\xi|$



Note: The factory setting for the refraction coefficient K is 0.142.

8.3 Assembling and Disassembling for the Three-jaw Tribrach

It is convenient to assemble or disassemble the instrument from the tribrach by loosening or tightening the tribrach clamp.

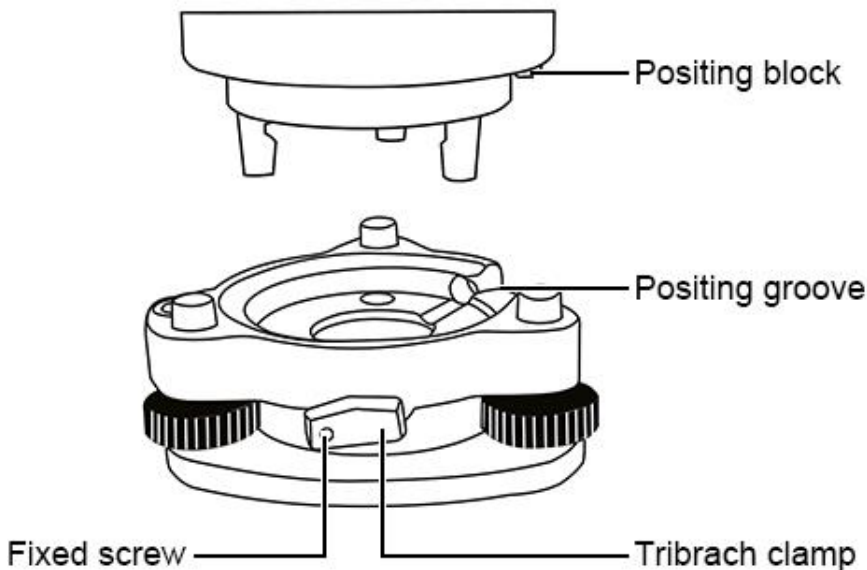

Disassemble

1. Rotate the tribrach clamp anticlockwise until the lever is loosened.
2. One hand hold up the tribrach, another hand hold the handle of the instrument and lift out the instrument from the tribrach.

Assemble

1. Lightly put the instrument into the tribrach, and let the communication port against in the indentation of the tribrach.
2. Rotate the tribrach clamp clockwise until the lever is tightened.

Fix the tribrach clamp



Note: If there is no need to frequently assemble or disassemble the instrument from the tribrach, it is necessary to fix the tribrach clamp by the fixed screw to avoid the disassembly by accident.

To fix the clamp, screw out the fixed screw by the screwdriver.

*To be the leading provider of high-precision professional,
solution & service in the global geospatial industry*

Shanghai eSurvey GNSS Co., Ltd.

Address: Building 4, No.651 Wanfang Rd, Pujiang Town, Minhang District, Shanghai, China

E-mail: Sales: info@esurvey-gnss.com Support: support@esurvey-gnss.com

Hot-line: +86 21 54467213

Website: <https://esurvey-gnss.com/>

