

E3 TOTAL STATION USER GUIDE



Copyright © Shanghai eSurvey GNSS Co., Ltd. 2021. All rights reserved.

No part of this document may be reproduced or transmitted in any form or by any means without prior written consent of Shanghai eSurvey GNSS Co., Ltd.

Trademarks and Permissions

 and other eSurvey trademarks are trademarks of Shanghai eSurvey GNSS Co., Ltd.

All other trademarks and trade names mentioned in this document are the property of their respective holders.

Notice

The purchased products, services and features are stipulated by the contract made between eSurvey and the customer. All or part of the products, services and features described in this document may not be within the purchase scope or the usage scope.

The information in this document is subject to change without notice. Every effort has been made in the preparation of this document to ensure accuracy of the contents, but all statements, information, and recommendations in this document do not constitute a warranty of any kind, express or implied.

Certificate



The device complies with part 15 of the FCC rules. Operation is subject to the following conditions:

- This device may not cause harmful interference.
- This device must accept any interference received, including interference that may cause undesired operation.



This product has been tested and found to comply with European Council Directive 2014/30/EU, thereby satisfying the requirements for CE Marking and sale within the European Economic Area (EEA). These requirements are designed to provide reasonable protection against harmful interference when the device is operated in a residential or commercial environment.

Notice Symbol: Product executive standard: GB/T 27663



: Precautions and important notes to be known before operation.



: Sections referenced.



: Supplementary instructions.



: Introduction to a special term or operation

[ENT] and others : Keys on the operating keyboard of the instrument.

(Procedures) and others : Software information displayed.

<Procedure menu> and others : Screen prompt name.

Conventional precautions

Before using this instrument, do check to make sure the instrument functions well.

No collimation of the instrument directly to the sun

Collimating the instrument directly to the sun may cause serious damage to eyes. Collimating the objective lens to the sun may also damage the instrument.

Setup of the instrument on the tripod

For setting up the instrument, a wooden tripod shall be used as far as possible. Use of a metallic tripod may affect the measurement accuracy due to vibration.

Mounting the base

Improper mounting of the base may also affect the measurement accuracy. Regularly check the adjustable screws on the base, and make sure screws connecting the base and the alidade are tightly locked. The central fixing screw on the base should be tight.

Avoiding libration of the instrument

During transport, the instrument should be properly protected to minimize impact of libration on the instrument.

Carrying the instrument

For carrying the instrument, it is required to hold the instrument handle tight.

High-temperature environment

The instrument may not be exposed to high temperature for too long, or its performance will be affected.

Sharp temperature change

Sharp change of temperature on the instrument or prism may shorten the measuring range. When the instrument is taken out of a warm car, it should be placed aside for a while for accommodation to the ambient temperature before being used for measurement.

Battery check

Before operation, check the battery level.

Take out battery

It is not advised to take out of the battery when the instrument is on. Or saved data may be lost. For consideration of the foregoing, it is better to turn off the instrument before removing the battery.

Responsibility with respect to saved data

Neither the manufacturer nor the representative office should be held responsible for loss of any saved data incurred by improper operation.

Noise inside of the instrument

When the instrument is working, you may hear noise from the instrument motor. This is normal and will not affect operation of the instrument.

Signs for safe use

To ensure safe operation and avoid personal damage or property loss, “Warning” and “Caution” statements are used in this Manual to remind you of conditions to follow. Before going through the main text of this Manual, you are requested to understand meanings of these statements.



Warning: Improper operation without this statement being observed may result in serious injury or death.



Note: Improper operation without this statement being observed may result in personal injury or property loss.

Precautions for safe use



Warning

- Disassembly or repair of the instrument without authorization may incur a fire, electric shock or damage to objects.
Disassembly and repair may only be performed by the manufacturer and the representative office.
- To avoid eye damage or blinding, do not collimate the instrument directly to the sun.
- To avoid high temperature causing a fire, do not cover the charger upon charging.
- To avoid the risk of fire or electric shock, do not use any damaged power cable, plug or socket.
- To avoid the risk of fire or electric shock, do not use wet battery or charger.
- To avoid explosion, do not expose the instrument to flammable gas or liquid; non-explosion-proof total stations may not be used in a coal mine.
- The battery may cause explosion or damage, if it is placed in fire or high temperature.
- To avoid the risk of fire or electric shock, do not use any charger other than that designated by the manufacturer.
- To avoid fire, do not use any power cable other than that designated by the manufacturer.
- Short-circuiting of the battery may cause a fire, and thus should be prevented during storage.

 **Note**

- Do not disassemble or assemble the instrument with wet hands; or otherwise electric shock may occur.
- Turning over the instrument case may cause damage to the instrument.
Do not stand or sit on the instrument case.
- Take care of the tripod tiptoe during setup or handling to avoid damage.
- Fall of the instrument or instrument case may cause damage to the instrument.
Do not use an instrument case with defective strap, agrafe or hinge.
- Do not touch acid liquid leaking from the battery. If you get the liquid on your skin or clothes due to carelessness, do wash it off with a plenty of water and undergo medical treatment.
- Do mount the base properly; or otherwise fall of the base may result in damage.
- Fall of the instrument may lead to serious consequences.
Check if the instrument is properly fixed onto the tripod.
- Fall of either the tripod or the instrument may cause serious consequence.
Check to make sure screws on the tripod are tightened.
- Upon packing, brake locking may damage the instrument.
Therefore, do check to make sure the braking screw is loosened upon packing.

User

1) The product can only be used by a professional. The user must be a surveyor of required qualification level or an individual with equivalent surveying knowledge so that he can understand the Manual and safety instructions upon use, inspection and calibration of the instrument.

Disclaimer

- 1) The user of this product shall operate the product fully in observance of the instructions, and regularly check performance of the instrument.
- 2) Neither the manufacturer nor the representative office shall be held liable for any direct or indirect consequence or profit loss resulted from destructive or intended improper use.
- 3) Neither the manufacturer nor the representative office shall be held liable for any direct or indirect consequence or profit loss resulted from natural disasters (such as earthquake, windstorm, flood, and so on), fire, accident or a third party.
- 4) Neither the manufacturer nor the representative office shall be held liable for failure of the product due to data change, loss or work interference.
- 5) Neither the manufacturer nor the representative office shall be held liable for any consequence or profit loss due to failure of operating the instrument following this Manual.
- 6) Neither the manufacturer nor the representative office shall be held liable for any consequence or profit loss resulted from improper handling or connection of the instrument to any other product.

Safety standard for laser beam used to measure distance

E3 uses visible laser. E3 is manufactured and sold according to requirements for laser beam safety provided in the “Performance standard for light-emitting products”

(FD. BRH21CFR 1060) and “Radiation safety, equipment grading, requirements and user’s guide for laser products”

(IEC 60825-1). According to the standards above, E3 is a “laser product of category I” when in the lens or reflector plate mode, or a “laser product of category III” when in the lens-free distance measurement mode. When the instrument fails, do not disassemble it by yourself without authorization, but contact the manufacturer or distributor.

Safety standard for laser beam used for laser centered product

For E3 laser centered product, visible laser is used. The E3 laser-centered type product is manufactured and sold according to requirements for laser beam safety provided in the “Performance standard for light-emitting products” (FD. BRH 21CFR 1040) and “Radiation safety, equipment grading, requirements and user’s guide for laser products” (IEC 60825-1).

E3 according to the foregoing standards is a “laser product of category II”.

When the instrument fails, do not disassemble it by yourself without authorization, but contact the manufacturer or distributor.

Marks

The E3 instrument carries the following marks to call the user’s attention to laser beam safety.



Precautions for safe use of laser

- It is required to follow safety warnings in this Manual or tags on the instrument, so as to ensure safe use of this product.
- It is strictly forbidden to direct a laser beam to anyone’s eyes as it may cause serious damage.
- It is forbidden to directly look to a laser beam emission source, as it may cause permanent damage to the eyes.
- It is forbidden to stare at a laser beam, as it may cause permanent damage to the eyes.
- It is forbidden to observe a laser beam with a telescope, as it may cause permanent damage to eyes.

Table of Contents

1 Description of keys.....	2
2. Battery use.....	3
2.1 Battery level icon.....	3
2.2 Battery change.....	4
2.3 Battery charging.....	4
3. Preparation for measurement.....	5
3.1 Centering.....	5
3.2 Leveling.....	6
3.3 Display of the leveling device on the screen.....	7
3.4 Focusing and collimating.....	8
3.5 Switching on/off.....	9
3.6 Quick setting of the instrument.....	10
3.7 Input of digits and letters.....	11
3.8 Tilt correction of vertical and horizontal angles.....	12
4. Angle measurement.....	13
4.1 Measurement of angle between two points.....	13
4.2 Setting a known direction.....	14
5. Distance measurement.....	15
5.1 Distance and angle measurement.....	16
6. Coordinate measurement.....	17
6.1 Entering the instrument data.....	17
6.2 Calling known coordinate data in memory.....	19
6.3 Rear view azimuth setting.....	20
6.4 Three-dimensional coordinate measurement.....	21
7. Resection measurement.....	23
7.1 Coordinate resection measurement.....	24
7.2 Elevation resection measurement.....	26
8. Staking out measurement.....	29
8.1 Angle and distance staking out measurement.....	29
8.2 Coordinate staking out measurement.....	31
8.3 Remote elevation staking out measurement.....	33
9. Area Measurement.....	34
10. Offset measurement.....	37
10.1 Single-distance offset measurement.....	37
10.2 Angle offset measurement.....	39
10.3 Dual-distance offset measurement.....	40
11. Opposite side measurement.....	42
11.1 Multi-point distance measurement.....	42
11.2 Changing the starting point.....	44

12. Remote elevation measurement.....	45
13 Point projection.....	47
13.1 Definition of baseline.....	47
13.2 Point projection.....	49
14. Linear staking out.....	50
14.1 Definition of baseline.....	50
14.2 Linear point staking out.....	51
14.3 Linear line staking out.....	52
15. Reverse calculation with coordinates.....	53
16. Polar coordinate calculation.....	55
17. Arc staking out.....	57
17.1 Two-point and radius arc staking out.....	57
17.2 Three-point arc staking out.....	59
18. Road measurement.....	61
18.1 Entering road parameters (horizontal).....	61
18.2 Entering road parameters (vertical).....	64
18.3 Road calculation.....	65
18.4 Road staking out.....	66
18.5 Road file editing.....	67
19. Saving coordinates.....	68
19.1 Save instrument data.....	68
19.2 Save angle data.....	70
19.3 Save distance data.....	71
19.4 Save flag data.....	72
19.5 Data search.....	73
20. File operation.....	74
20.1 File selection.....	74
20.2 File renaming.....	76
20.3 File deletion.....	77
20.4 Communication output.....	78
21. Known coordinate data manipulation.....	79
21.1 Enter known coordinate data by using the keyboard.....	79
21.2 Enter known coordinate data via communication input.....	80
21.3 Delete known coordinate data.....	81
21.4 View known coordinate data.....	82
21.5 Clear all known coordinate data.....	83
22. Attribute code.....	84
22.1 Enter attribute code.....	84
22.2 Clear code data.....	85
23. Select storage medium.....	86
24. USB (USB flash disk) mode.....	87
25. Setting of Instrument Parameters.....	88

25.1 Setting of parameters relating to distance measurement.....	88
25.2 Setting of observation conditions.....	90
25.3 Instrument setting.....	92
25.4 Communication setting.....	93
25.5 Unit setting.....	94
25.6 Key setting.....	95
26. Check and correction.....	96
26.1 Check and correction of instrument constants.....	96
26.2 Check and correction of tubular level.....	97
26.3 Inspection and calibration of the circular level.....	98
26.4 Check and correction of the telescope's coarse sighting device.....	99
26.5 Check and correction of laser centering device.....	100
26.6 Check and correct the vertical line of telescope reticle.....	101
26.7 Check and correct the instrument collimation error.....	102
26.8 Check and correct the index error i of the vertical circle.....	103
26.9 Check and correct zero position error of the tilt compensator.....	105
26.10 Optical axis and telescope sighting axis for distance measurement.....	107
27. Attachments.....	108
Appendix 1: Atmospheric correction formula and atmospheric correction graph (only for reference)	109
Appendix 2: Atmospheric refraction and earth curvature correction.....	110
Appendix 3: Removal of three-jaw base.....	111

Parts of the instrument



1 Description of keys



Keys	Name	Function
F1~F4	Soft key	Function reference is shown at the bottom of the screen
9~±	Digit and symbol keys	1. Enter corresponding digits in case of digit input; 2. Enter corresponding symbols above the keys in case of letter or special character input
⏻	Power button	It is used to control power on/off of the instrument
💡	Background light key	It is used to turn on/off the background light of the instrument screen
📏	Object key	It is used to change the object type of the instrument
!	Softkey	It is used to enable/disable the softkey mode
Esc	Escape key	It is used for return to the previous menu or mode
Fn	Toggle key	1. It can realize toggling input from letter to digit, or vice versa in the input screen mode 2. It can realize toggling between the first and second functions of the keys in the measurement mode.
∠	Angle key	In case of the measurement interface, it can be used to realize switching between horizontal and vertical angle display
📏	Distance key	In case of the measurement interface, it can be used to realize distance display
📍	Coordinate key	In case of the measurement interface, it can be used to realize coordinate display
S. O	Staking out key	It is used for direct entry into the staking out procedure menu
*	Page-Up and Page-Down keys	In the measurement mode, it can be used to realize page turning of the function information corresponding to softkey
MENU	Menu key	It is used for entry into the procedure menu interface
ENT	Enter key	It is used for selecting an option or confirming entered data

2. Battery use

2.1 Battery level icon

The battery level icon is used to indicate the residual power.

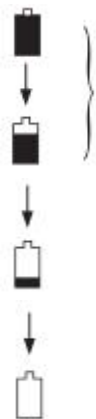
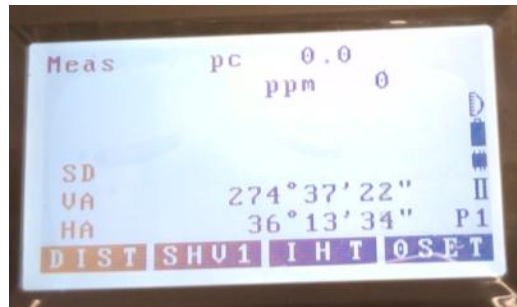

Power can be measured

The battery is low, and shall be charged or replaced

Power cannot be measured, and the battery must be immediately charged or replaced



Tip:

- How long the battery can last depends on many factors, including the ambient temperature, the charging duration, times of charging and discharging, and so on. To get fully prepared, it is recommended to charge the battery to its full capacity or prepare sufficient spare batteries.
- The battery level icon shows the battery level in the current measurement mode. The battery condition displayed in the angle measurement mode shall not apply for distance measurement. Since measuring distance consumes more power than measuring angle, when the instrument switches from the angle measurement mode to the distance measurement mode, operation of the instrument may cease due to low battery.
- When the observation mode changes, the battery level icon will not necessarily indicate power reduction or increase. The battery level indication system is used to indicate the general condition of the battery capacity, other than instantaneous change of the battery level.
- It is recommended that before staking out for field measurement, you should first check capacity conditions of instrument battery and spare batteries.

2.2 Battery change



Note:

- When the instrument is left unused, the battery should be removed.
- Before disassembly of the instrument, be sure to turn off the power first.
- Upon installing or removing the battery, take care to prevent access of water drops or dust into the main unit.
- Regularly clean the contactor of the main unit power source by using a piece of clean cloth, so as to maintain its cleanness.

► Steps

- 1) Put the battery from up to down into the battery compartment;
- 2) Close the battery compartment inwards;
- 3) Turn the knob counterclockwise for locking.



► Battery removal

- 1) Turn the knob on the battery compartment clockwise for unlocking;
- 2) Pull out the battery compartment;
- 3) Take the battery out from the top.

2.3 Battery charging



As shown in the figure above, connect the charger to the battery, and then insert the plug of the charger adapter to a 220V AC power source; at this time, the charger indicator will turn red, indicating charging is under way; 6-8 hours later, the red indicator will turn green, indicating charging is completed.



Tip:

- In case of a new battery (or a battery that has been left unused for several months), it may achieve the optimal performance after several cycles of charging and discharging, and should be charged for at least 10 hours for the first few times.
- To charge the battery to its maximum capacity, it is recommended to maintain it under the charging state for 1~2 hours after the indicator turns green.
- Indicator status: Normally red indicator – under charging; normally green indicator – charging is completed; flashing red indicator – waiting, no load, poor contact or battery failure.
- If after connection to the power, the red indicator flashes, please remove the charger from the AC power source, and wait for a while before reconnecting it to the AC power source.

3. Preparation for measurement

3.1 Centering

► Steps

(1) Put the tripod horizontally stable

Make sure legs of the tripod are equally long, the tripod head is set level at the measuring point, and the tripod legs are firmly supported on the ground.

(2) Setup of the instrument

Put the instrument on the tripod head, with one hand holding the instrument and the other hand turning the central screw tight.

(3) Positions of the measuring point and the laser point

Turn on the laser centering device to observe its position relative to the measuring point, and appropriately adjust the relative position.

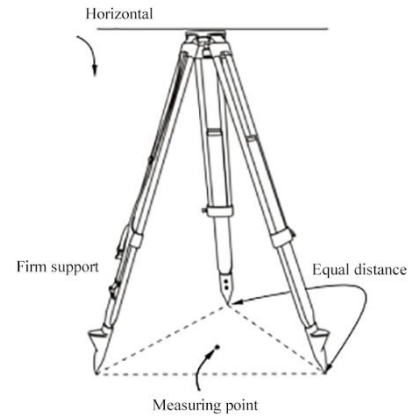

3.2 Leveling

► Steps

1) Turn on the laser

- Press [ON] to turn the instrument on.
- Press [Fn] and [.] to display the electronic level on the screen.
- Press ► to adjust the level of laser lightness.

Level 0 (default) indicates that the laser is turned off while level 1 - 4 indicate that the laser is turned on.



2) Set the measuring point to the center of the reticle

Adjust the foot screw of the instrument to position the measuring point at the center of the centering circle.

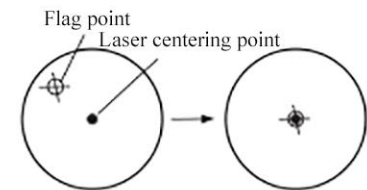

2) Center the bubble of the circular level

Center the bubble by shortening the tripod leg closest to the bubble or lengthening the tripod leg farthest from the bubble; this operation may be repeated.

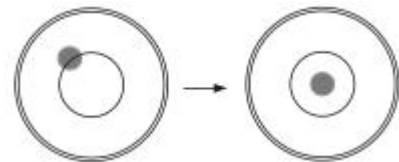

3) Center the bubble of the alidade level

Release the horizontal hand brake wheel, turn the alidade to make the long bubble parallel to the line connecting foot screws A and B, turn the foot screws A or B to center the bubble, and the bubble will move towards the foot screw turning clockwise.

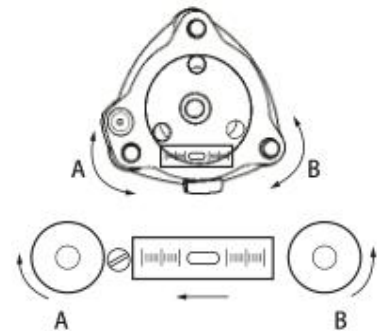

4) Turn 90° to center the bubble

Turn the alidade by 90° to make axis of the alidade level perpendicular to the line connecting foot screws A and B; turn the foot screw C to center the bubble.

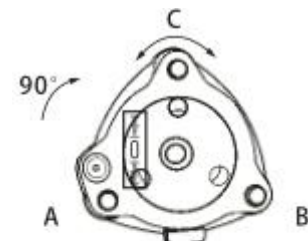

5) Turn another 90° and check the bubble position

Turn the alidade by another 90° and check if the bubble is centered; if no, follow the steps below:

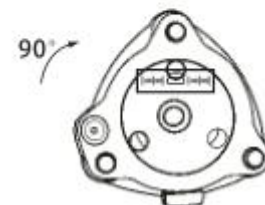

- Turn the foot screws A and B equally in opposite directions to make the bubble move toward the center by half of the deviation.
- Turn the alidade by 90°, and turn the foot screws.
- Make the bubble move toward the center by half of the deviation.



Tip:

- If the bubble cannot be centered through operation following the steps above, please calibrate the tubular level.

☞ Refer to “27.3 Inspection and calibration of the circular level”

6) Check if the bubble is at the same position in any direction

Check if the bubble is at the same position in any direction; if no, level it by repeating the steps above.

7) Align the instrument to the measuring point

Loosen the central screw a bit; observe through the objective lens of the optical centering device, while carefully sliding the instrument on the tripod head to set the measuring point at the center of the reticle.

8) Double check to make sure the alidade bubble is centered

If it is not, repeat steps after step (3).

3.3 Display of the leveling device on the screen

► Steps

1) Press [ON] to turn it on.

2) Press [Fn] and then [.] to display the electronic level on the screen.

“●” is the round bubble of the electronic level; the ranges of tilt angle on the inner and outer circles of the level is $\pm 3'$ and $\pm 6'$, respectively.

The tilt angle in the X and Y directions are simultaneously displayed on the screen.

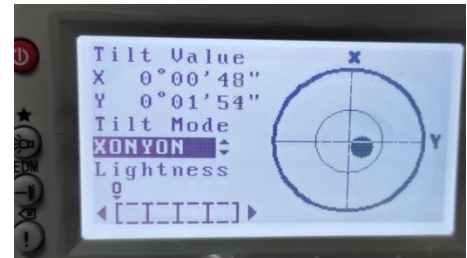

3) Center the original bubble.

☞ Refer to step 1) and 2) in “3.2 Leveling”.

4) Turn the alidade of the instrument to make the telescope parallel to the line connecting foot screws A and B; then turn the horizontal brake screw.

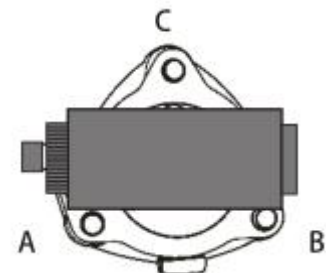

5) Turn the foot screws A and B to make the tilt angle “0” in X direction; turn the foot screw C to make the tilt angle “0” in Y direction.

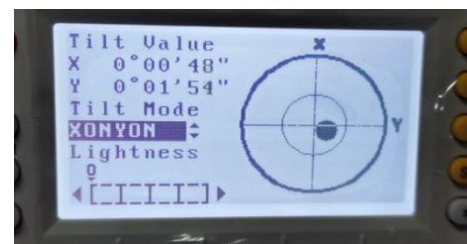

6) Press [ESC] to end the operation.

3.4 Focusing and collimating

► Steps

1) Eyepiece focusing

Use the telescope to observe a bright background. Turn the eyepiece clockwise to the maximum extent, and then turn it counterclockwise slowly until the clearest image of the reticle is obtained.

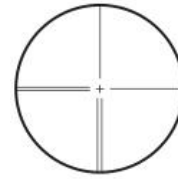

2) Collimating target

Loosen the vertical and horizontal brake screws; use the coarse sighting device to sight the target in the field of view, and then lock the two brake screws.

3) Objective lens focusing

Turn the focusing ring of the telescope until the clearest image of the target is obtained.

Use the vertical and horizontal tuning screws to collimate the reticle precisely at the target. The inching hand wheel shall finally turn clockwise.

4) Re-focusing until no collimation error

Perform focusing again until there is no collimation error between target imaging and the reticle.

Note:

- For observation at a different plate position, use the same position of the reticle to collimate the target.



Collimation error

Collimation error occurs when a relative displacement is incurred between the target imaging and the reticle by slight move of the observer's eyes in front of the eyepiece.

Collimation error may lead to error in the readings observed, and thus should be eliminated before observation. It can be eliminated by proper focusing.

3.5 Switching on/off

► Switching-on procedures

1) Press [⏻] to turn on the instrument; then the instrument will undergo self-inspection, and subsequently display the interface on the right side.

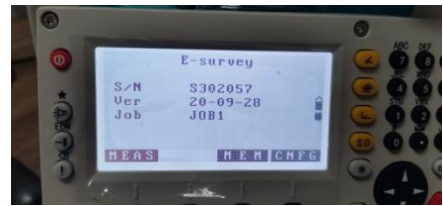

2) Press [F1] and select (Measure) to enter the measurement mode.

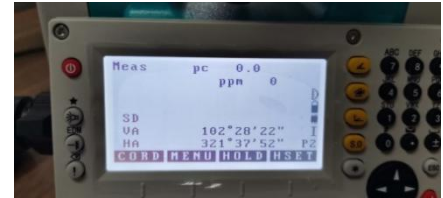

Press [F3] and select (Memory) to enter the memory mode.



Press [F4] and select (Setting) for system setting.

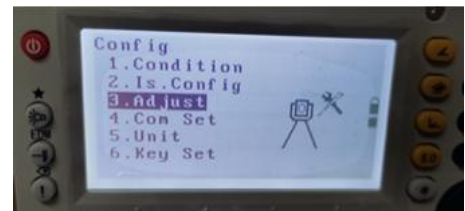

► Switching-off procedures

When the instrument is in the working state, press [⏻] and the screen in the right figure will show; press [F3] (Yes), the instrument will go off; or press [F4] (No), it will go back to the original interface.



3.6 Quick setting of the instrument

Press [Fn] and then [], you may see several setting options. These options are routine settings of the instrument, and can be set at any time during operation of the instrument.

The instrument can be set as follows:

1. Enable/disable the laser alignment;
2. Adjust contrast of the LED display;
3. Adjust brightness of the reticle;
4. Enable/disable the key buzzer;
5. View the returned signal.

► Procedures for quick setting of the instrument

Press [Fn] and then [] to enter the quick setting mode of the instrument.

1) Set the laser alignment

When option (1. Laser alignment) is subject to anti-blackening display, press the left or right arrow key to enable or disable laser alignment; (Yes) means alignment enabled, and (No) means alignment disabled.

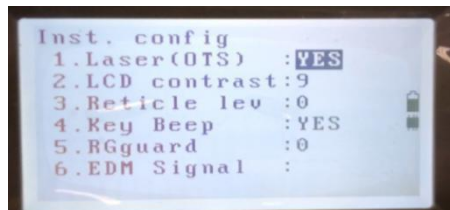
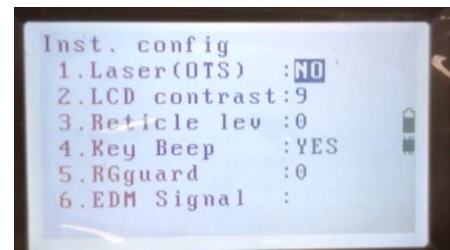

2) Adjust the display contrast

Press the up/down arrow key or [2] to make option (2. Contrast) subject to anti-blackening display; then press the left or right arrow key for adjustment; the display contrast of the screen will change with the number.

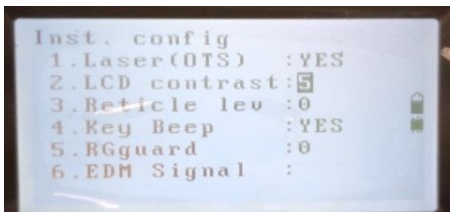

3) Adjust the reticle brightness

Press the up/down arrow key or [3] to make option (3. Reticle brightness) subject to anti-blackening display; then press the left or right arrow key for adjustment; the reticle brightness will change with the number; when the number becomes to 0, it means the reticle lighting is turned off.

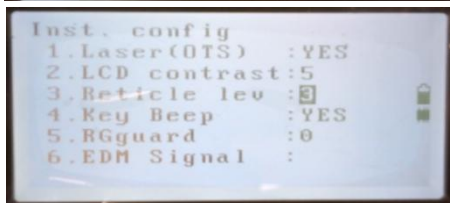

4) Press the up/down arrow key or [4] to make option (4. Key buzzer) subject to anti-blackening display; then press the left or right arrow key to enable or disable the key buzzer; (Yes) means the buzzer enabled, and (No) means the buzzer disabled.

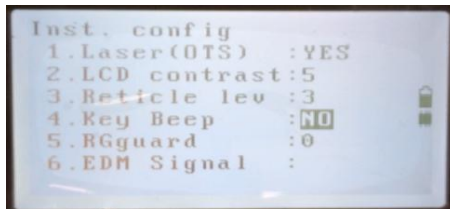

5) View the returned signal

When the instrument collimates the prism, press the up/down arrow key or [5] to make option (5. Returned signal) subject to anti-blackening display; at this time, the screen will display the numerical value. This option can only be used for viewing the data, which will change with the weather condition, the target distance and other distance-related conditions, and cannot be manually modified.

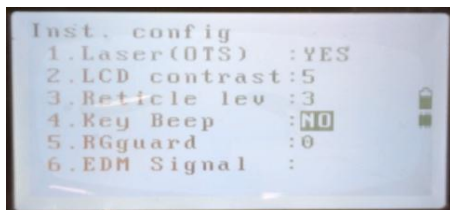

3.7 Input of digits and letters

Example: Input a code

► Steps

1) Enter the code input window; the place where the cursor blinks is the current input location; icon A on the right side of the screen shows if the current key is pressed to enter an uppercase/lowercase letter or special symbol.

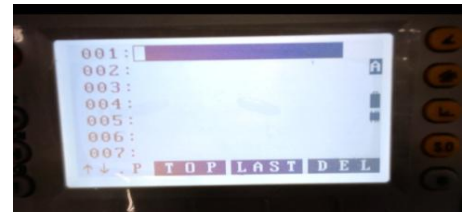

2) Each key is defined with three letters; each time when it is pressed, one of the letters will appear at the cursor position; when the required letter appears, press the right arrow key to move the cursor to the next input position (if letters of two inputs are not on the same key, straightly press the next key).

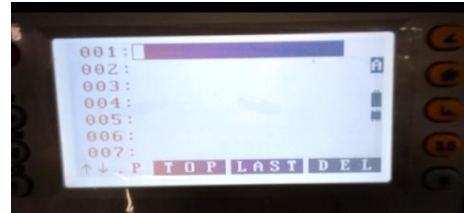

3) Press [Fn] to switch to the numeric mode for entering digits. In the numeric mode, each key corresponds to a digit, and one digit can be entered by pressing corresponding key for once; after entering a digit, the cursor will automatically move to the next input position.



4) After completion of input, press [ENT] for confirmation, and the instrument will save the entered code; when all codes are input, press [ESC] to exit from the code input screen.

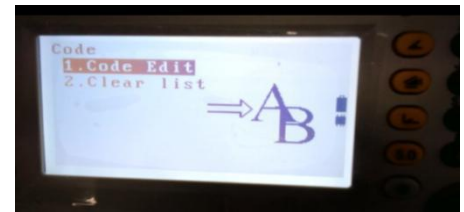

Tip:

- Press [Fn] to realize cyclic switching between uppercase mode, lowercase mode and numeric mode.
- If a wrong character is entered, simply move the cursor onto the wrong character by using the arrow keys, and then directly enter the new correct one for correction.

3.8 Tilt correction of vertical and horizontal angles

When the tilt sensor is enabled, corrections required to be made with respect to the vertical and horizontal angles due to nonconforming levelness of the instrument will be displayed.

For precise angle measurement, it is required to enable the tilt sensor. The tilting degree displayed can also be used for precise leveling of the instrument. If "Out of compensator's limit" is displayed, it means the instrument has tilted beyond the automatic offset range, and requires manual leveling.

E3 may offset an error in readings of the vertical and horizontal angles resulted from tilting of the instrument's vertical axis in the X or Y direction.

When the instrument tilts beyond the correction range, it will automatically go to the electronic bubble screen; at this time, the instrument cannot work normally, and requires further leveling for normal measurement.

X: Tilt value of the vertical axis in the rotating direction of the telescope.

Y: Tilt value of the vertical axis in the rotating direction of the vertical telescope.

Turn the foot screws to level the instrument; when the instrument is leveled, the display will automatically return to the previous state.

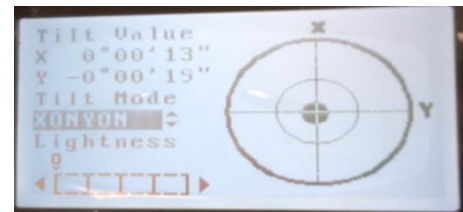
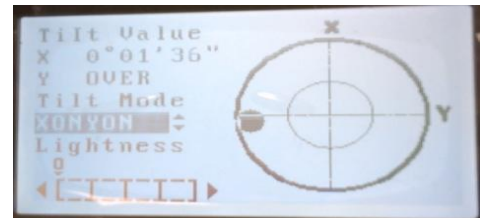

Tip:

- When dual-axis compensation is enabled, it is normal that rotating the telescope will affect the horizontal angle to some extent in case of horizontal braking due to tilting of the vertical axis in Y direction.
- On the electronic bubble interface, the laser centering device can be enabled/disabled; meanwhile, [◀] and [▶] can be used to adjust the brightness.

4. Angle measurement

This section introduces basic steps of angle measurement.

4.1 Measurement of angle between two points

Use the horizontal angle “zero setting” function to measure the included angle between the two points. This can be used to set the value in any direction to zero.

► Steps

1) As shown in the right figure, collimate the instrument to target point A.

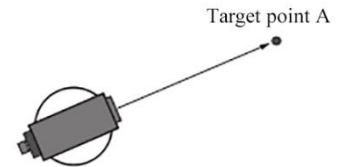

2) Under the first-page menu in the measurement mode, press [F4] (Zero setting), and it will start flashing.

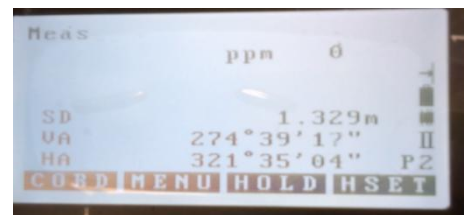

3) Press [F4] (Zero setting) again, and the direction value of target point A is set to zero.

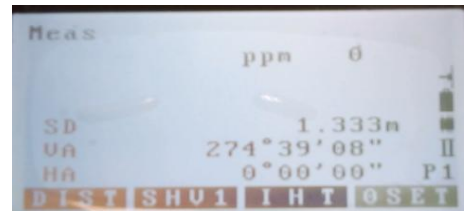

4) Collimate target point B.

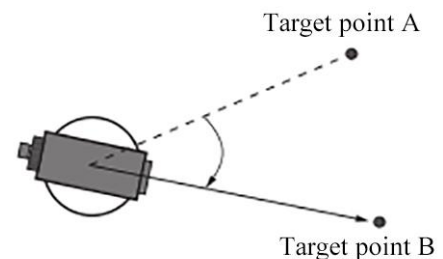

The horizontal angle “36°05'19”” shown in the right figure is the included angle between the target points.

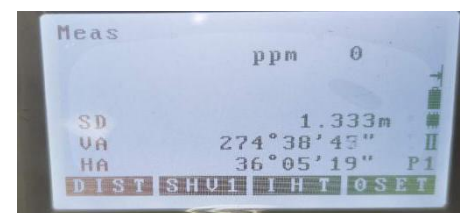

4.2 Setting a known direction

Use the horizontal “angle setting” function to set the collimation direction to a desired value, and then measure the angle.

► Steps

- 1) Collimate the instrument to target point A.
- 2) Press [*] for paging over to enter the second page in the measurement mode.

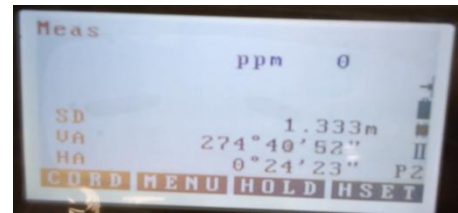

- 3) Press [F4] (Angle setting). Rear view orientation

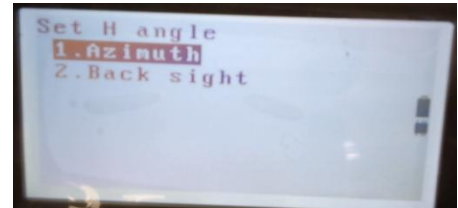

- 4) Use arrow keys to select “1. Angle orientation” and make it subject to anti-blackening display; press [ENT] to confirm it or directly press [1].

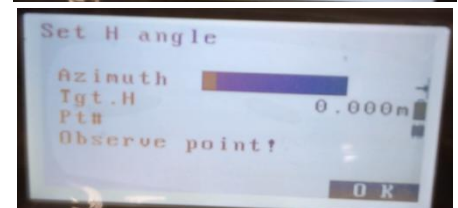

- 5) Enter the known direction value and press [ENT] to set the collimation direction to the desired value. As shown in the right figure, the set angle value is 12°30'05”.

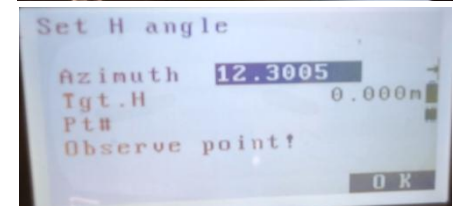

- 6) Press [F4] (OK) to collimate target point B.

The “horizontal angle” displayed is the direction value of target point B; the difference between the value and the set value of target point A is the included value of the two target points. As shown in the right figure, the included angle is “111°06'13””.

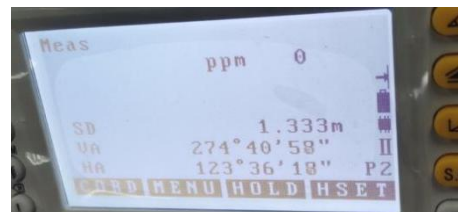

Tip:

- Use the (Locking) function to lock the desired direction value; collimate the target point to unlock it.



For definition of the (Locking) function, refer to steps 1) and 2) in “3.2 Leveling”.

5. Distance measurement

Before distance measurement, it is first required to set the following:

- Distance measurement mode
- Reflector type
- Prism constant correction
- Atmosphere correction
- EDM receiving

 Refer to “Distance measurement parameter setting” and “Instrument parameter setting”

 Note:

- Check to make sure the set target type of the instrument is consistent with that actually measured; the instrument will automatically adjust the output laser intensity and match the observed distance value with the used target type; or otherwise the accuracy of the measurement will be affected.
- Dirt on the objective lens will affect the measurement accuracy. Upon maintenance, use a lens brush to remove dust on the objective lens first, and then use special lint to wipe it clean.
- In case of no coordinated target measurement, any highly reflective object (such as metal or white surface) posing between the instrument and a target to be measured will affect the accuracy of measurement.

5.1 Distance and angle measurement

The instrument can be used for concurrent measurement of distance and angle.

► Steps

- 1) Collimate the target.
- 2) Enter the first page in the measurement mode.

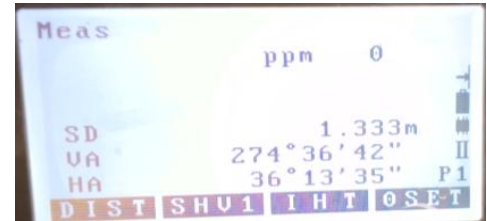

- 3) Press [F1] (Distance measurement) to start measuring the distance.

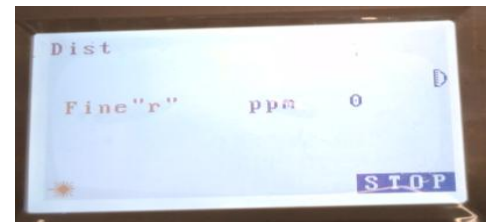

Upon start of distance measurement, the instrument will flash and display the distance measurement mode, the prism constant correction, the meteorological correction and other information.

After a short beep, the screen will show the measured slope distance, vertical angle and horizontal angle.

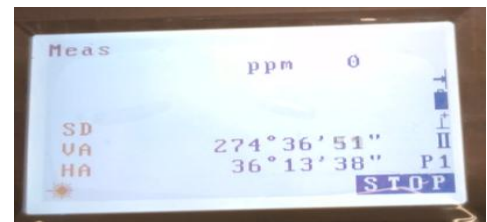

- 4) Press [F4] (Stop) to stop distance measurement.

- Press [F2] (SHV1) to realize switching of the distance value between the slope distance, the horizontal distance and the vertical difference; press [] to switch to the distance display mode.

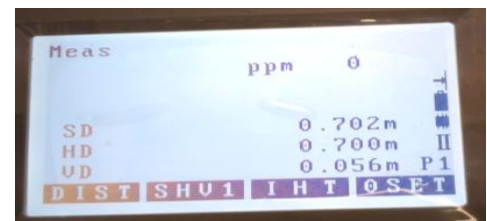

Tip:

- Set the distance measurement mode to single accurate measurement, and the instrument will stop measuring after each measurement is done.
- If the distance measurement mode is set to average accurate measurement, then distance-1, distance-2...distance-9 are displayed; after completion of measurement, the average distance will be displayed in the line of distance-A.

6. Coordinate measurement

The three-dimensional coordinates of a target point can be measured after setting of the instrument and its rear view azimuth.

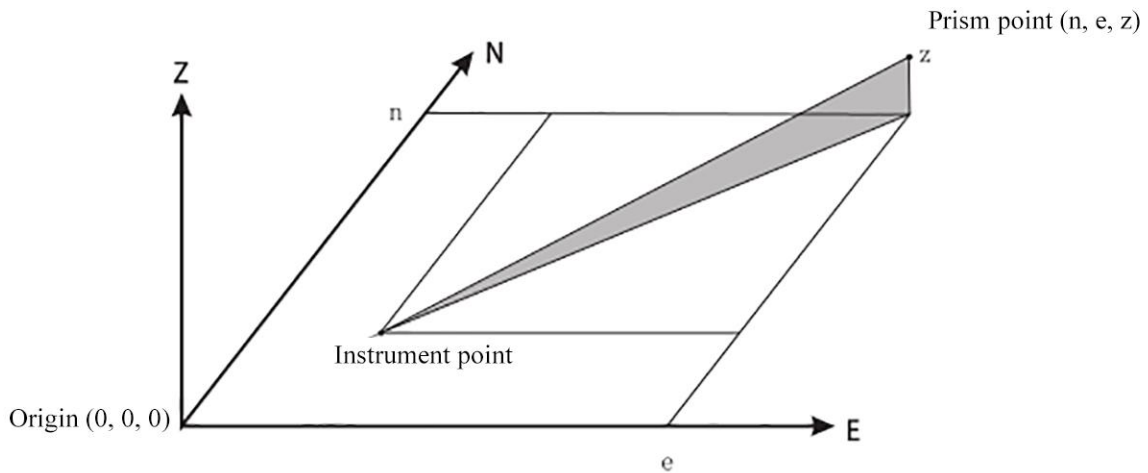

- Relevant parameters of electronic distance measurement can also be set under the coordinate measurement menu.

 Refer to “Distance measurement parameter setting” and “Instrument parameter setting”

6.1 Entering the instrument data

► Steps

- 1) Measure the instrument height and the target height.
- 2) Enter the second page in the measurement mode.

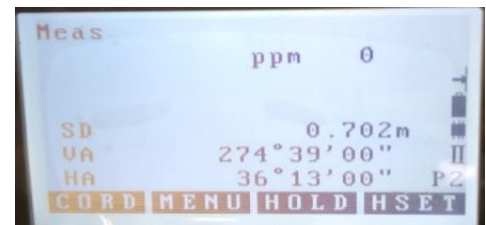

- 3) Press [F1] (Coordinate) to enter the <Coordinate measurement> screen.

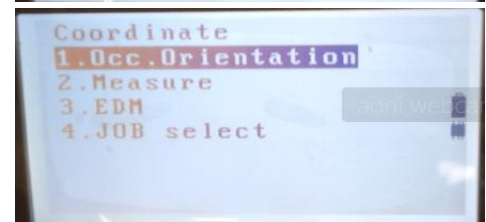

4) Select "Instrument orientation".

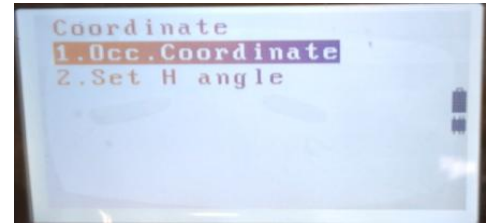

5) Select "Instrument coordinate".



6) Enter the point name, instrument height, code, coordinates of station measured, user name, temperature and atmospheric pressure, among other data.

- To call any known coordinates stored in the instrument, press [F1] (Call).



 Refer to "6.2 Calling known coordinate data in the memory"

7) Press [F4] (OK) to confirm the entered coordinate value, and the instrument will automatically enter the rear view orientation menu.

- To save the measuring data, press [F3] (Record).

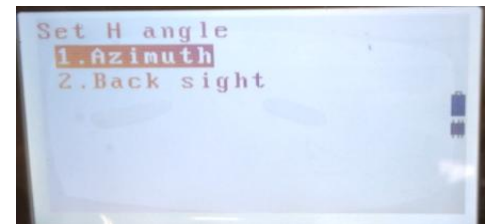

6.2 Calling known coordinate data in memory

► Steps

Any known coordinate data saved to the current file and the coordinate search file can be called by (reading). Before calling, please check to make sure the coordinate file containing the required coordinate has been selected as the target file for coordinate search in the memory mode.

 Refer to “Input and delete known coordinates” and “Select a file”

1) Upon entering the instrument data, press [F1] (Call), and the screen will display a list of known coordinate data, as shown in the right figure.

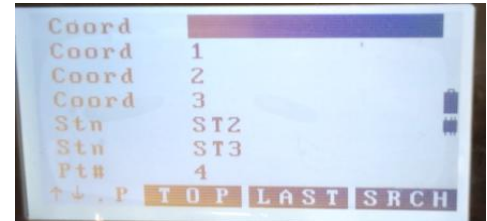

Point: Known point data in the current file and the coordinate search file.

Coordinate/instrument: Coordinate data in the current file and the coordinate search file.

2) Move the cursor to the right of the required point number; press [ENT] to read and display the point number and its coordinate.

- Press [F1] (↑ ↓. P), and then press [▼] / [▲] to display the previous or next line.
- Press [F1] (↑ ↓. P) for anti-blackening, and then press [▼] / [▲] to display the previous or next line.
- Press [F2] (First point) to move the cursor to the first point on the first page.
- Press [F3] (Final point) to move the cursor to the final point on the final page.
- Press [F4] (Search) to go to the coordinate data search screen, and enter the point to be searched for searching; if there is a great quantity of known data, the search will last long.

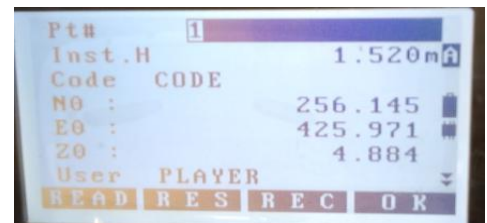

2) Press [F4] (OK) to confirm the instrument data read in.

- Coordinate data read in can be edited; such editing will not affect the original data; after editing, the point number will no longer show.



Note:

- The point number read in will appear in the current file.
- To search a coordinate by using the search function, the instrument will first search the current file, and then the coordinate file to be searched.
- When there are a multiple of the same point number in the current file, the instrument will find out data corresponding to the latest point number.

6.3 Rear view azimuth setting

The rear view azimuth can be obtained through reverse calculation by using coordinates of the instrument point and the rear view point.

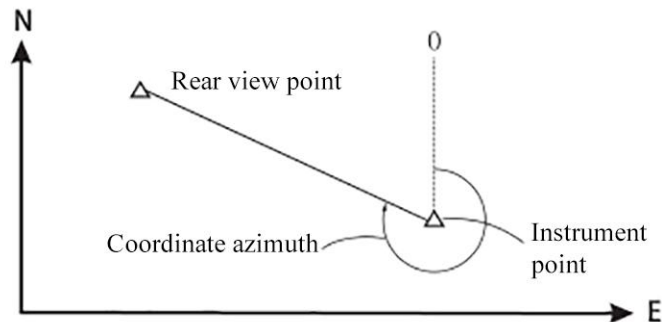

► Steps

1) Select "Instrument orientation" on the <Coordinate measurement> screen.



2) Select "Rear view orientation".

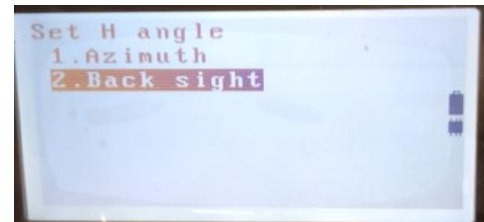

3) Select "Rear view" and enter the coordinate of the rear view point.

- To call any known coordinates stored in the instrument, press [F1] (Call).

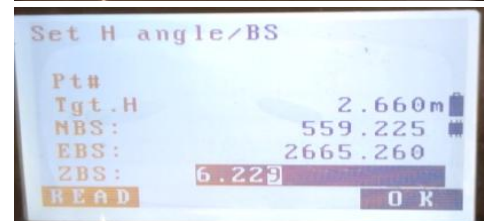

Refer to "6.2 Calling known coordinate data in the memory" Calling OK

4) Press [F4] (OK) to confirm the entered rear view point data.



5) Upon collimating the rear view point, press [F4] (OK) to set the rear view azimuth.

6.4 Three-dimensional coordinate measurement

After setting the instrument and its rear view azimuth, you may start to measure the three-dimensional coordinate of a target point.

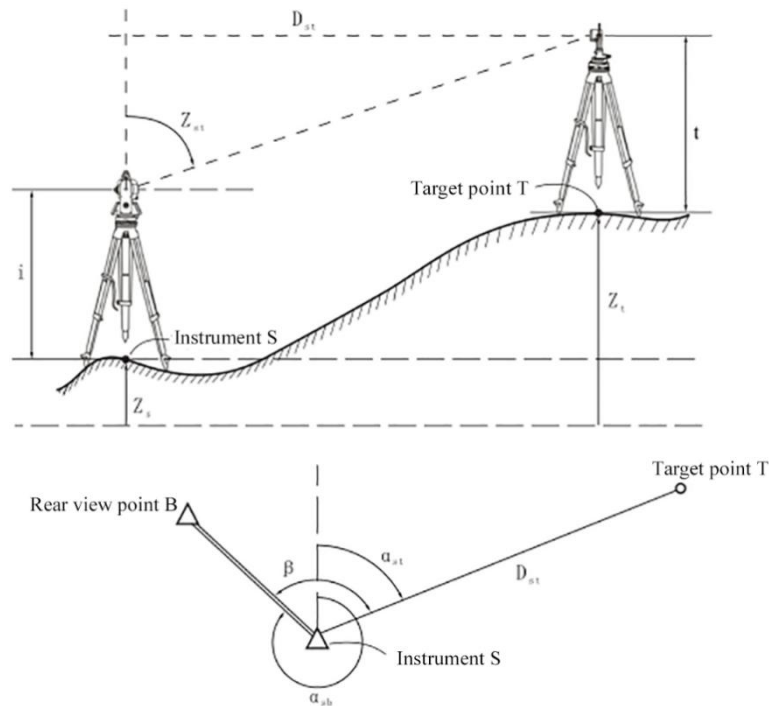

Calculation formula for the three-dimensional coordinate of a target point:

$$\alpha_{sb} = \arctan \left(\frac{E_b - E_s}{N_b - N_s} \right)$$

$$\alpha_{st} = \alpha_{sb} + \beta$$

$$N_t = N_s + D_{st} \cos \alpha_{st}$$

$$E_t = E_s + D_{st} \sin \alpha_{st}$$

$$Z_t = Z_s + D_{st} / \tan Z_{st} + i - t$$

Where:

α_{sb} : Rear view azimuth	E_b : Rear view point E coordinate	E_s : Instrument point E coordinate
	N_b : Rear view point N coordinate	N_s : Instrument point N coordinate
α_{st} : Target point azimuth	β : Horizontal angles between rear view B, instrument point S and target point T	
N_t : Target point N coordinate	D_{st} : Instrument point N coordinate	
E_t : Target point E coordinate		
Z_t : Target point Z coordinate	Z_s : Instrument point Z coordinate	i : Instrument height
		t : Target height

► Steps

- 1) Prism mounted at the collimated target point.
- 2) Enter the <Coordinate measurement> interface.

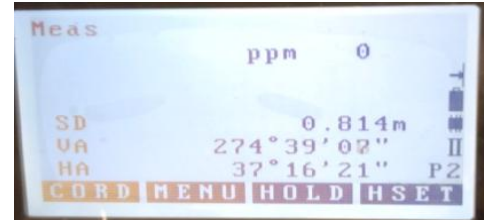

- 3) Select “Measure” to start coordinate measurement; the coordinate value of the measured target point will show on the screen.

- Press [F2] (Elevation) to enter additional instrument data.
- If the target height of the target point observed is different, enter the target height before observation.
- Before or after observation, press [F2] (Elevation) and enter the target height; the target point Z coordinate will update correspondingly.

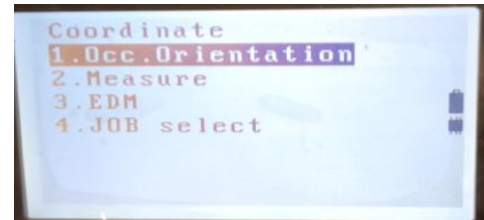

- 4) Collimate the next target point, and press [F1] (Observe) to start measuring. Repeat the same procedures for all target points.

- 5) Press [ESC] to end coordinate measurement and return the <Coordinate measurement> interface.

7. Resection measurement

Resection measurement can be performed by measuring multiple known points to determine coordinate of the instrument point. Coordinates saved the memory can be used as known data for calling. Residual of each point can be checked when needed.

Input value and measured value
 Coordinate of known point: X_i, Y_i, Z_i
 Measured horizontal angle: H_i
 Measured vertical angle: V_i
 Recorded measurement: D_i

Output value
 Coordinate of instrument: X_0, Y_0, Z_0

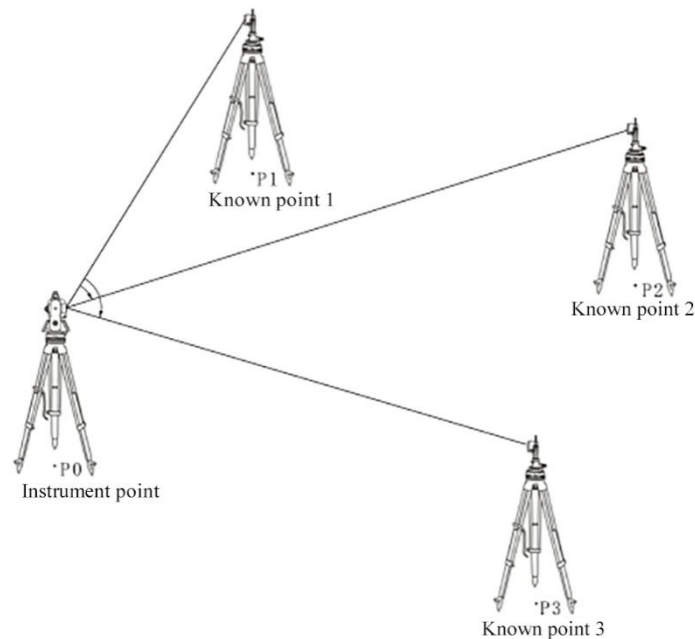

- Known points can be measured to determine the three-dimensional coordinate of the instrument point or merely elevation of the instrument point.
- Coordinate resection measurement will cover N, E and Z data of the instrument point, while elevation resection measurement will only cover Z data of the instrument point. Perform resection measurement according to “7.1 Coordinate resection measurement” and “7.2 Elevation resection measurement”.
- Upon resection measurement, known coordinate data entered and instrument point data obtained through resection can be saved to the current file.

7.1 Coordinate resection measurement

Determining the three-dimensional coordinate of the instrument point requires:

- Measuring the distance and angle of 2~5 known points.

► Steps

1) Enter the second page in the measurement mode.

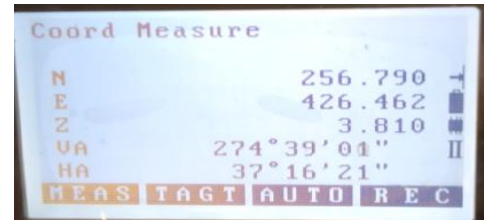

2) Press [F2] (Procedure) to enter the <Procedure menu> screen.

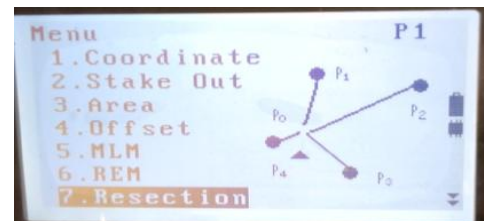

3) Select "Resection" and enter.

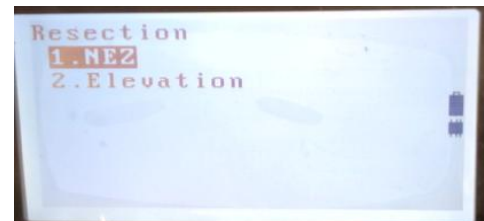

4) Select "Coordinate" and enter data of a known point.



5) Enter coordinate data of the first known point, and press [F3] (Next) to enter coordinate data of the second known point. Repeat the same procedure to enter coordinate data of all known points.

- Press [F1] (Call) to call known coordinates in the memory.

Refer to "6.2 Calling known coordinate data in the memory"

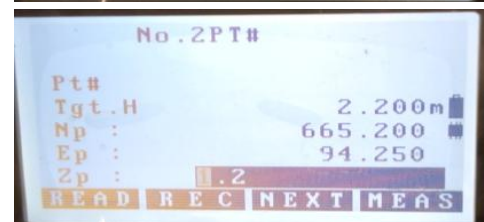

6) Press [F4] (Measure) to start resection measurement.

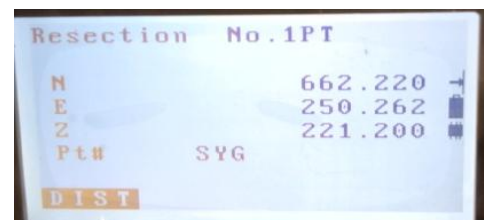

7) Collimate the first known point, and then press [F1] (Distance measurement) to start measuring.

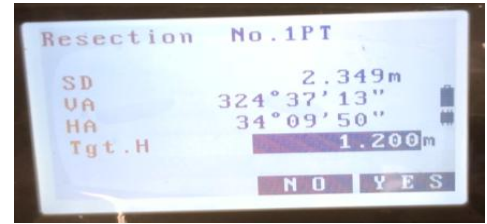

8) Press [F4] (Yes) to confirm use of the measured value for the first known point.

- At this time, you may also enter the target height.

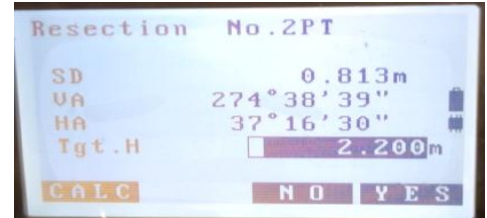

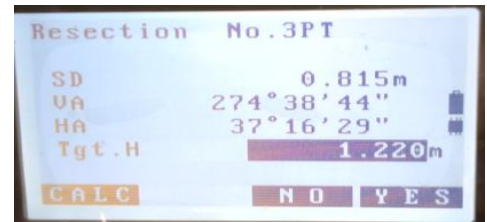

9) Repeat steps 7) and 8) to measure other known points in sequence. When measurements are sufficient for calculating the coordinate of the instrument point, the screen will show (Calculate).

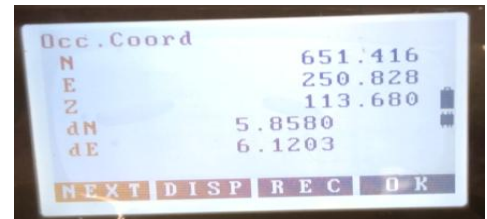

10) When all known points are measured, press [F1] (Calculate) to determine the coordinate of the instrument point. After calculation, the coordinate of the instrument point and its standard deviation will show.

- Press [F1] (Next) to enter coordinate of an additional known point.
- Press [F2] (Display) to show measurements of resection points; the data can be edited.
- Press [F3] (Record) to record measurements.



 Refer to "Save data"

11) Press [F4] (OK) to end resection measurement.

- First collimate a known point, and then press [F4] (Yes) to take the known point 1 as the rear view azimuth of the rear view setting.
- Press [F3] (No) to directly return to <Resection> without setting the azimuth.

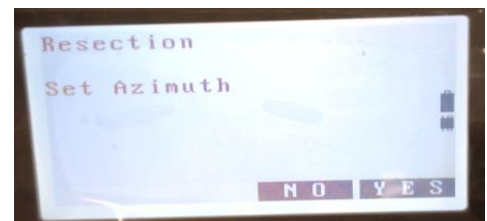

7.2 Elevation resection measurement

Measure known points to determine elevation of the instrument point.

- For measurement of known points, corresponding distance must be measured.
- The number of known points to be measured ranges between 1~5.

► Steps

1) Under the second-page menu in the measurement mode, press [F2] (Procedure), and select “Resection”.

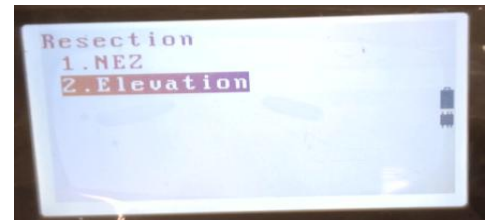

2) Select “Resection elevation” and enter data of a known point.



3) After entering elevation data of the first known point, press [F3] (Next) to enter coordinate data of the second known point. Repeat the same procedure to enter coordinate data of all known points.

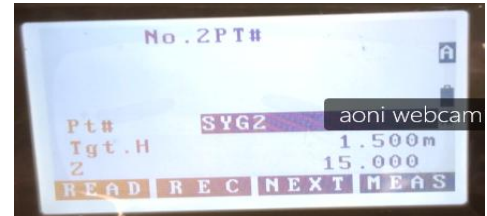

- Press [F1] (Call) to call known coordinate data in the memory.

 Refer to “6.2 Calling known coordinate data in the memory”

4) Press [F4] (Measure) to start resection measurement.

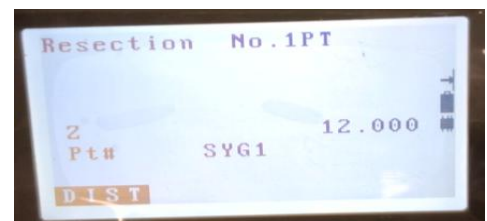

5) Collimate the first known point, and then press [F1] (Distance measurement) to start measuring.

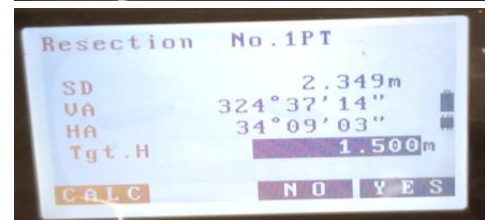

6) Press [F4] (Yes) to confirm use of the measured value for the first known point.

- At this time, you may also enter the target height.

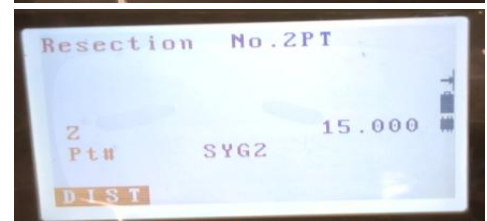

7) Repeat steps 5) and 6) to measure other known points in sequence.

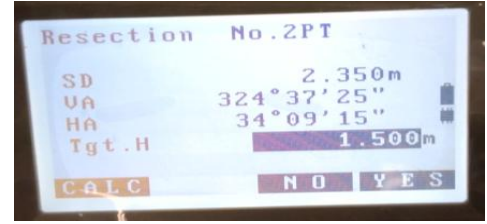

8) When all known points are measured, press [F1] (Calculate) to calculate the elevation of the instrument point. After calculation, the elevation of the instrument point and its standard deviation will show.





- Press [F1] (Next Point) to enter the coordinate of another known point.
- Press [F4] (OK) to end the elevation resection measurement and complete elevation setting of the instrument; for N and E coordinates, the original values are taken.
- Press [F3] (Record) to record measurements.

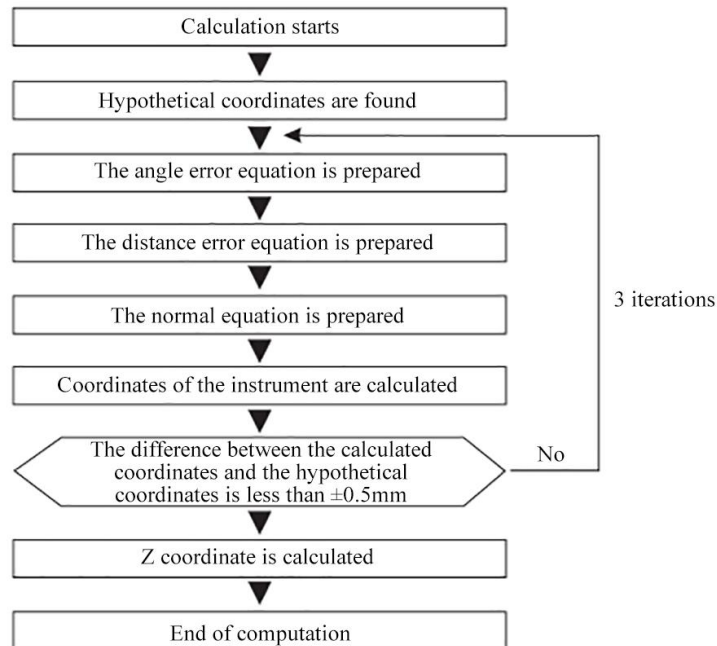

Resection calculation process

N and E coordinates of the instrument point are obtained by establishing angle and distance error equations and using the least squares principle; for Z coordinate of the instrument point, the average value is taken as the final result.



 Precautions for resection

When the measured point is on the same circumference with three or more known points, it is possible that coordinates of the instrument cannot be determined.

The condition shown in the following figure is desirable.

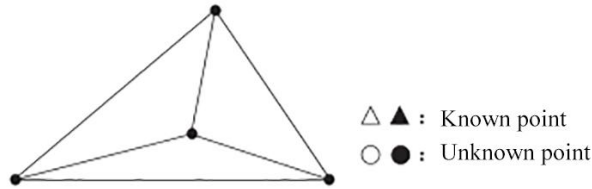

In the condition shown in the following figure, it is possible that no correct result can be obtained:



When known points are on the same circumference, one of the following methods can be taken for measurement:

- (1) Set the instrument, as far as possible, at the gravity center of the triangle formed by the known points.

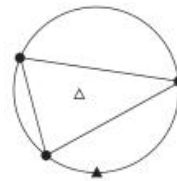

- (2) Measure additional known points that are not on the same circumference.



- (3) Perform distance measurement with respect to at least one of the known points.



 Note:

- When the included angle between known points is too small, it is impossible to calculate coordinates of the instrument point. The farther the instrument is away from a known point, the smaller the included angle is with the known point, and the more possible the points are on the same circumference.

8. Staking out measurement

Staking out measurement is performed to determine desired point positions in field. In the staking out process, the instrument will measure the angle, distance or coordinates of a collimated point, and display the difference between the preset staking out value and the measured value, providing guidance for staking out.

Differences displayed can be calculated by using the following formulas:

Difference of horizontal angle:

$dHA = \text{staking out value of horizontal angle} - \text{Measured horizontal angle}$

Distance difference:

$S - OS = \text{Measured slope distance} - \text{Staking out value of slope distance}$

$S - OH = \text{Measured horizontal distance} - \text{Staking out value of horizontal distance}$

$S - OV = \text{Measured vertical difference} - \text{Staking out value of vertical difference}$

- Staking out can be performed in terms of slope distance, horizontal distance, vertical difference, coordinates or remote elevation.
- Parameters of electronic distance measurement can be set under the staking out measurement menu.

8.1 Angle and distance staking out measurement

Staking out in terms of angle and distance is to establish desired point positions based on measured angle of rotation relative to a reference direction and distance to the instrument point.

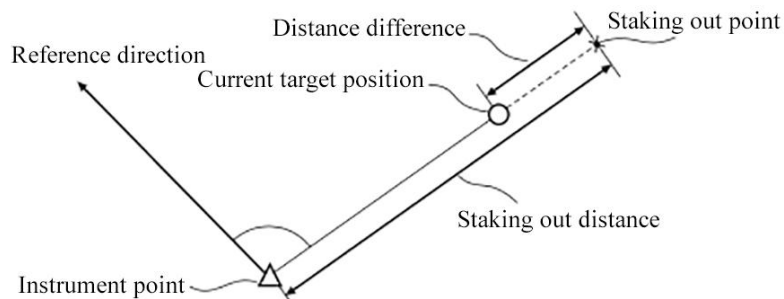

► Steps

1) Enter the second page in the measurement mode; press [F2] (Procedure) to enter the <Procedure menu> screen.

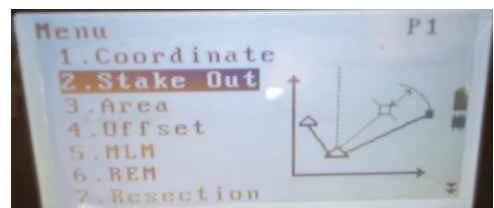

2) Select "Staking out measurement" and enter.

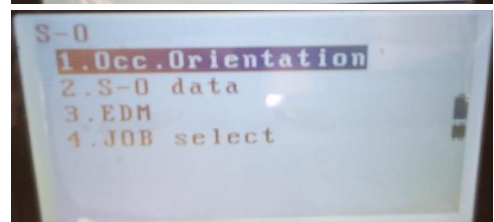

3) Enter the instrument data.

 Refer to steps 4)-6) in "6.1 Entering the instrument data"

4) Set the rear view coordinate azimuth.

 Refer to steps 2)-5) in "6.3 Rear view azimuth setting"

5) Select "Staking out measurement" and enter.



6) Select "Angle and distance" and enter. Press [F2] (Switch) and select the distance input mode. Press [F2] (Switch) to switch the input mode between slope distance, horizontal distance and vertical difference.

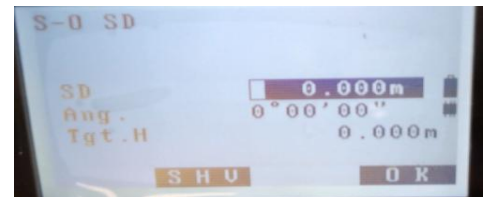

7) Enter the following values:

① Slope distance /horizontal distance/vertical difference staking out value

Staking out distance between the instrument and the staking out point.

② Angle staking out value

The included angle between the staking out point direction and the reference direction.

③ Height of the collimated target

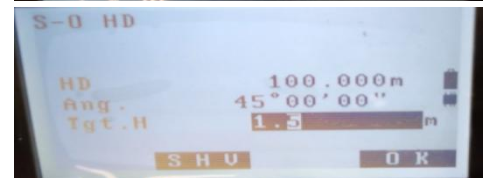

8) Press [F4] (OK) to confirm the entered staking out value.

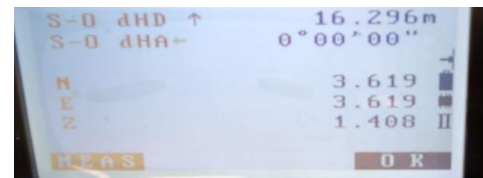

9) Rotate the instrument alidade to set the displayed "Staking out angle difference" to "0°", and set the prism to the collimation direction. Press [F1] (Measure) to start measuring. The screen will show the difference between the measured distance and the staking out value as "staking out horizontal distance".

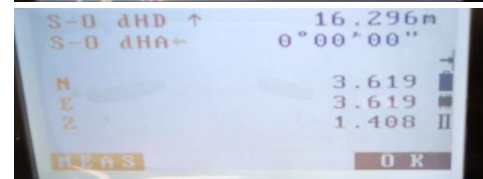

10) Move the prism along the collimation direction toward or away from the instrument to make the "staking out horizontal distance" "0".

Moving direction:

←: Move the prism leftwards

→: Move the prism rightwards

α: Move the prism toward the instrument

↑: Move the prism away from the instrument

11) Press [F4] (OK) to end staking out and return to the <Staking out measurement> screen.

8.2 Coordinate staking out measurement

Given coordinates of a staking out point, the instrument will automatically calculate the staking out angle and distance, and find out location of the staking out point relying on the angle and distance staking out function.

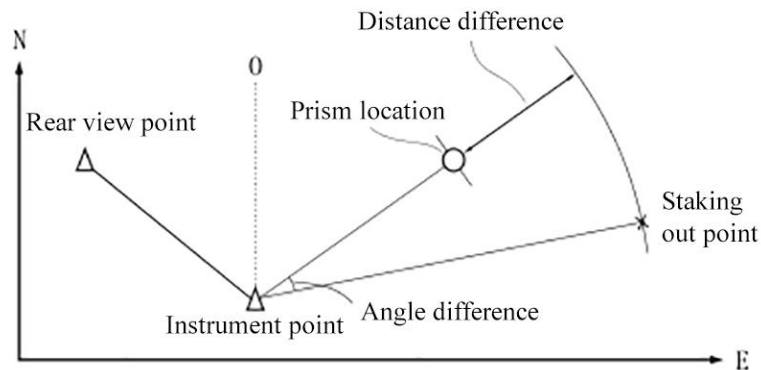

- To determine Z coordinate, set the target on a measuring bar or other object at the same height.

► Steps

1) Enter the second page in the measurement mode; press [F1] (Procedure) to enter the <Procedure menu> screen.

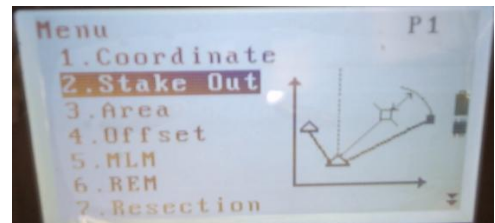

2) Select "Staking out measurement" and enter.

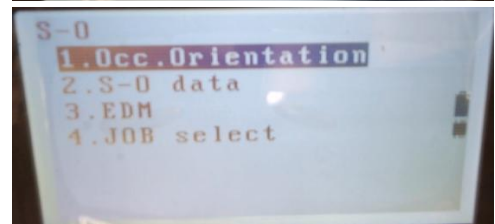

3) Enter the instrument data.

Refer to steps 4)-6) in "6.1 Entering the instrument data"

4) Set the rear view coordinate azimuth.

Refer to steps 2)-5) in "6.3 Rear view azimuth setting"

5) Select "Staking out measurement" and enter.



6) Select "Coordinate" and enter.

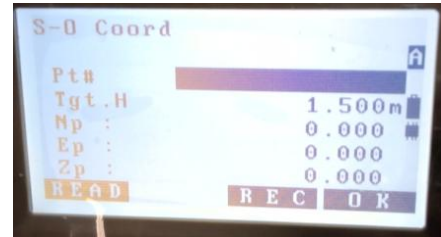

7) Enter coordinates of the staking out point.

- Press [F1] (Call) to call known coordinate data in the memory.

Refer to "6.2 Calling known coordinate data in the memory"

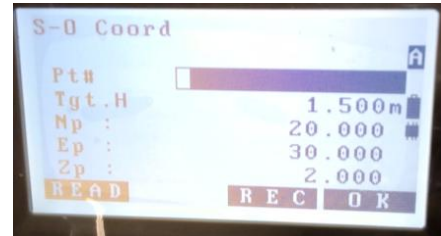

8) Press [F4] (OK) to confirm coordinates of the staking out point entered.

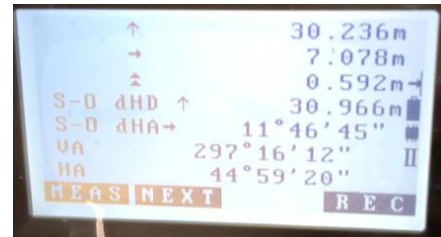

9) Press [F1] (Measure) to start coordinate staking out measurement.

Find out the staking out point location by measuring and moving the prism.

Refer to steps 9)-10) in "8.1 Angle and distance staking out measurement"

▲ : Lower than the staking out elevation.

▼ : Higher than the staking out elevation.

10) Press [ESC] to return to the <Staking out measurement> screen.

8.3 Remote elevation staking out measurement

Remote elevation staking out measurement is performed for staking out points that are too high or too low to set prisms.

 See “12. Remote elevation measurement”

► Steps

1) Set the prism right above or below the staking out point; use a measuring tape to measure the prism height (distance from the prism center down to the ground); press [Space] to enter the prism height.

2) Enter the second page in the measurement mode; press [F1] (Procedure) to enter the <Procedure menu> screen. Select “Staking out measurement” and enter.

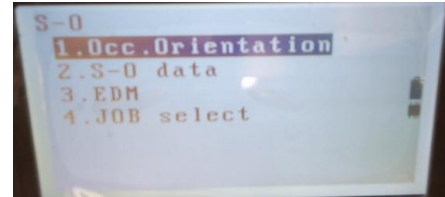

3) Enter the instrument data.

 Refer to steps 4)-6) in “6.1 Entering the instrument data”

4) Select “Staking out measurement” and enter.

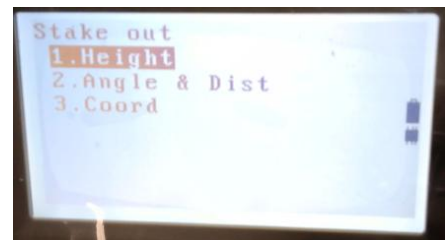

5) Select “Height” and enter.

6) Enter the data, and press [F4] (OK).

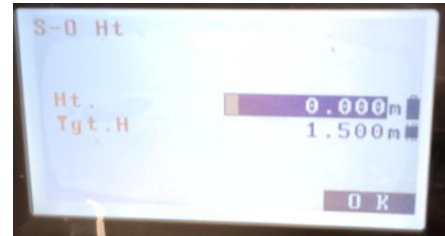

7) Press [F1] (Measure) to start measuring.

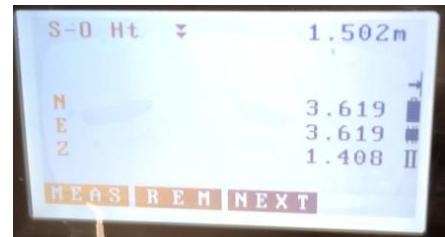

8) Press [F2] (Remote elevation) to start measuring.

Turn the telescope upwards or downwards to locate the staking out point.

 Refer to steps 9)-10) in “8.1 Angle and distance staking out measurement”

▲: Turn the telescope upwards.

▼: Turn the telescope downwards.

8) Press [ESC] to return to the <Staking out measurement> screen.

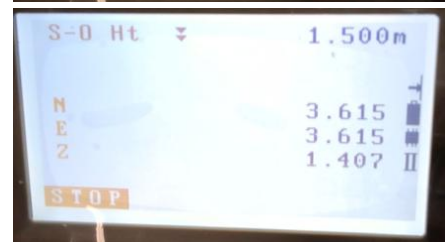

9. Area Measurement

Area measurement is to calculate area of the closed shape formed by lines connecting three or more points by calling coordinate data of these points in the instrument memory; the coordinate data may have been obtained by measurement or by manual input.

Input value

Coordinate value: P1 (N1, E1)

P2 (N2, E2)

P3 (N2, E2)

Output value

Area value: S

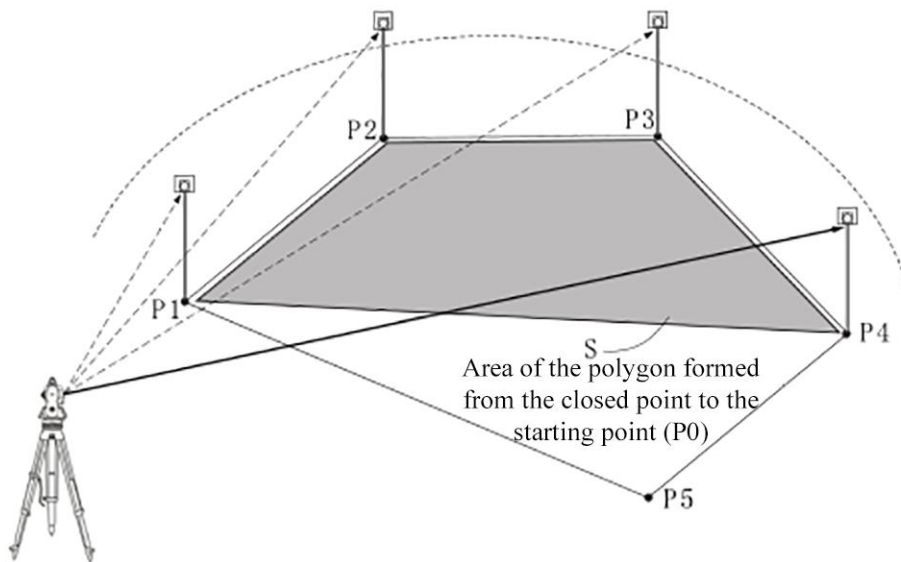

- Range of points forming the shape: 3-30 points.
- The area is calculated by using coordinates of the series of sequential points forming the closed shape; the sequential points used may have been directly measured, or previously entered into the instrument memory.

Note:

- The area calculated will be incorrect if less than 3 points are used for area calculation.
- The number of points forming the shape must be given in the clockwise or counterclockwise order; otherwise the calculation result will be incorrect.

Steps for area calculation by measuring points

1) Enter the second page in the measurement mode.

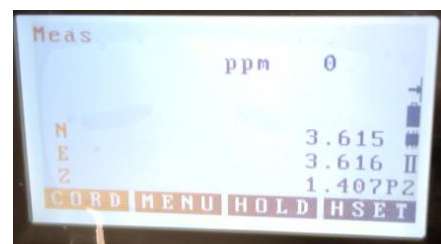

2) Press [F2] (Procedure) to enter the <Procedure menu> screen.

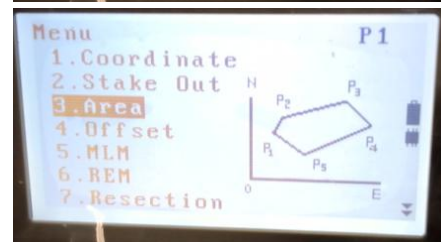

3) Select "Area measurement" and enter.



4) Select "Area".



5) Collimate the first boundary point in the closed area of area calculation, and then press [F4] (Measure); the measurement result will show on the screen.

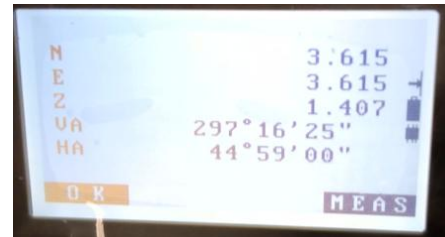

6) Press [F1] (OK) to take the measurement result as point "01".

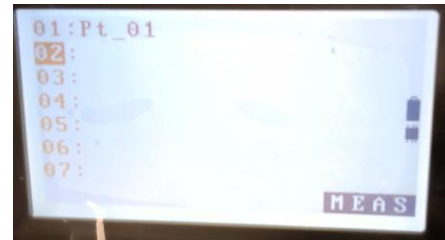

7) Repeat steps 4-6 to measure all boundary points in the clockwise or counterclockwise direction.

For example, an area defined by boundary points 1, 2, 3, 4 and 5 is the same as that defined by boundary points 5, 4, 3, 2 and 1.

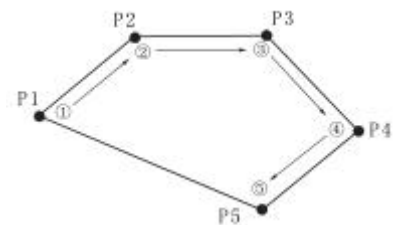

8) When sufficient known points are measured for area calculation, the screen will show (Calculate).

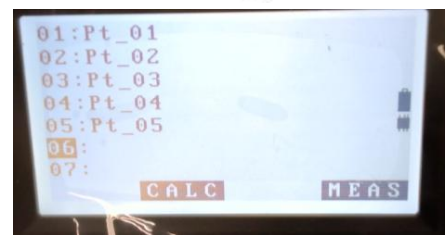

9) Press [F2] (Calculate) to calculate and display the result.

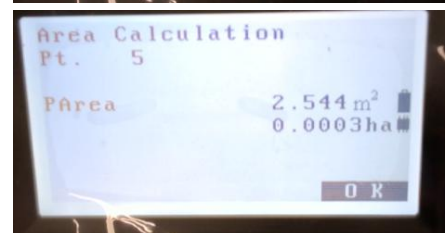

10) Press [F4] (OK) to end area calculation and return to <Procedure menu>.

► Procedures for calling coordinate points to calculate area

1) On the menu page 2 in the measurement mode, press [F1] (Procedure), and select “Area measurement”.



2) Press [F1] (Call) to call coordinate data of known points in the memory.

 Refer to “6.2 Calling known coordinate data in the memory”

3) Select the point number corresponding to the first boundary point in the list of known coordinate points, and press [ENT] to read coordinate of the point.



4) Repeat steps 2-4 to measure all boundary points in the clockwise or counterclockwise direction. When measurements of known points are sufficient for calculating the area, the screen will show (Calculate).



5) Press [F2] (Calculate) to calculate and display the result.

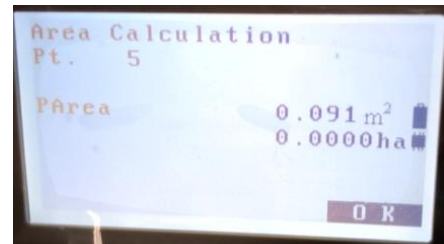

6) Press [F4] (OK) to end area calculation and return to <Procedure menu>.

10. Offset measurement

Offset measurement is performed to determine the distance and angle of any point where prism cannot be directly set or of any non-intervisible point.

When a to-be-measured point cannot be measured by setup of a prism or by reason of non-visibility or otherwise, a prism may be set at an offset point not far from the to-be-measured point; then distance and angle of the offset point are measured to derive those of the to-be-measured point.

The instrument provides the following three methods of offset measurement.

10.1 Single-distance offset measurement

Single-distance offset measurement is performed to measure a point by measuring the horizontal distance (offset distance) from the offset point to the to-be-measured point.

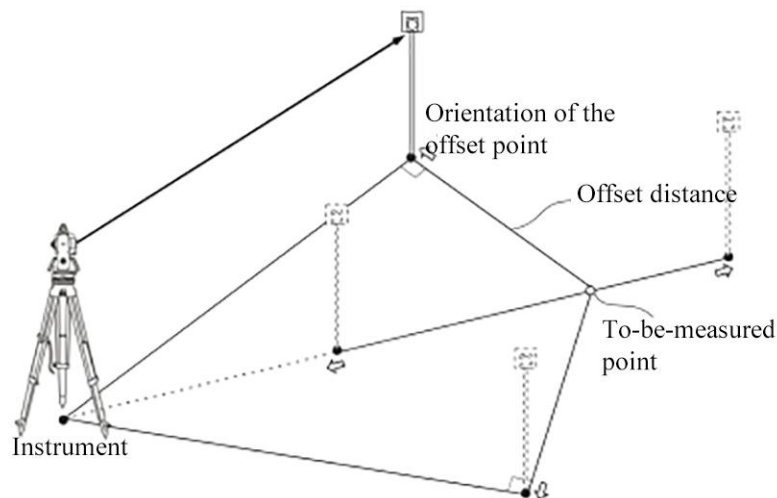

Tip:

- When the offset point is set on the left or right side of the to-be-measured point, it shall form an included angle of 90° with the instrument.
- When the offset point is set before or after the to-be-measured point, it shall located on the line connecting the measuring station and the to-be-measured point.

► Steps

1) Select a point not far from the to-be-measured point as the offset point; measure the distance between the two points, and set a prism at the offset point.

2) Under the second-page menu in the measurement mode, press [F1] (Procedure) to enter the <Procedure menu>; select "Offset measurement" and enter.

Or directly press [F2] (Offset) on the third page menu in the measurement mode to enter the <Offset measurement>.

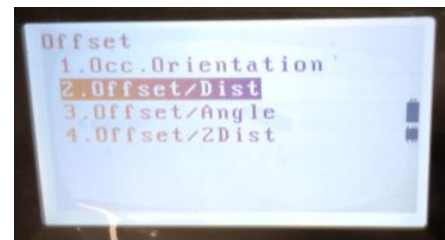
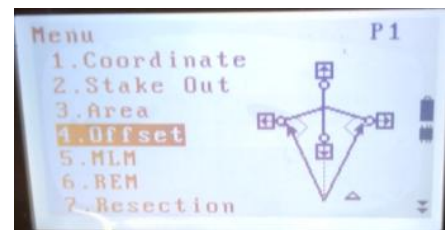

3) Enter the instrument data.

 Refer to “6.1 Entering the instrument data”

4) Set the rear view coordinate azimuth.

 Refer to “6.3 Rear view azimuth setting”

5) Select “Single-distance offset” on the <Offset measurement> interface, and enter.

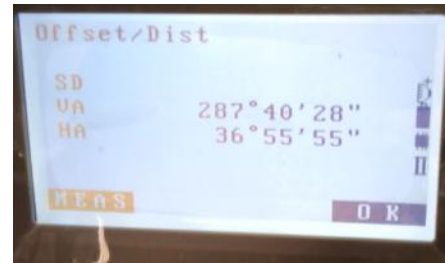

6) Collimate the prism, and press [F1] (Measure) to start distance measurement. When the measurement result is displayed, press [F4] (Stop) to stop measuring.



7) Press [F4] (OK). Enter the following values:

(1) Offset distance

(2) Orientation of the offset point

- Orientation of the offset point:

←: Located on the left side of the to-be-measured point

→: Located on the right side of the to-be-measured point

↑: Located at the back of the to-be-measured point

α: Located in front of the to-be-measured point

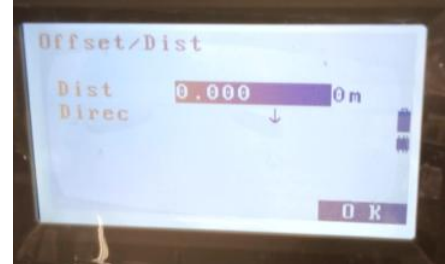

8) Press [F4] (OK) to calculate the distance and angle of the to-be-measured point.

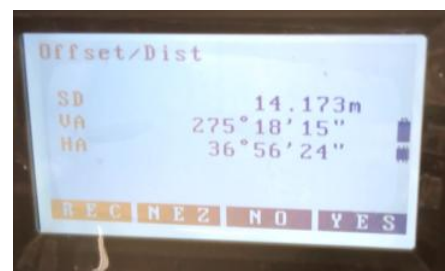

9) Press [F4] (YES) to return to the <Offset measurement> interface.

- Press [F2] (XYZ) to switch distance display to coordinate display.

Press [F2] (HVD) to switch coordinate display to distance display.

- Press [F3] (NO) to return to the screen that displays the original distance and angle.
- Press [F1] (Record) to save the calculation result.

10.2 Angle offset measurement

Angle offset measurement is performed to determine the distance, angle and coordinates of any point where prism cannot be directly set or of any non-intervisible point. When a to-be-measured point cannot be measured by setup of a prism or by reason of non-visibility or otherwise, a prism may be set at an offset point not far from the to-be-measured point; then distance and angle of the offset point are measured to derive those of the to-be-measured point. Upon angle offset measurement, the offset point approximates the to-be-measured point as far as possible and lies on the same circumference; distance of the offset point and its angle to the to-be-measured point are measured to derive measurements of the to-be-measured point. As shown in the following figure, set the prism at a point that is as equally distant from the instrument as point A0. After the instrument height and the prism height are set, measure coordinates of central point A0 or A1.

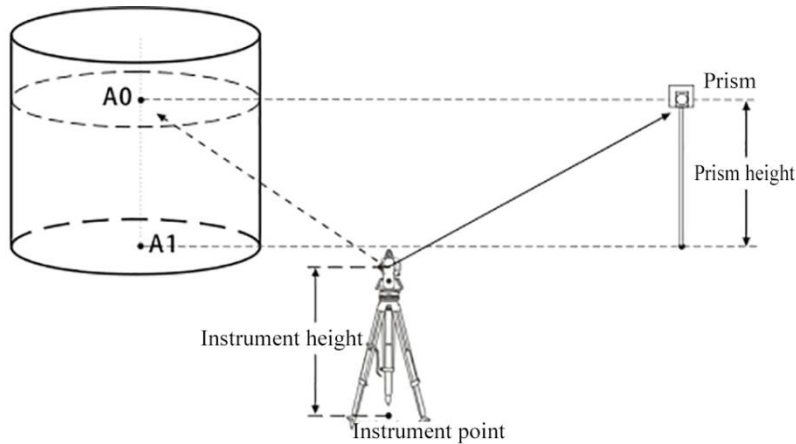

► Steps

1) Set an eccentric point near the to-be-measured point and make it as equally distant from the instrument as the to-be-measured point; set a prism at the offset point.

2) Under the second-page menu in the measurement mode, press [F1] (Procedure) to enter the <Procedure menu>; select "Offset measurement" and enter.

Or directly press [F2] (Offset) on the third page menu in the measurement mode to enter the <Offset measurement>.

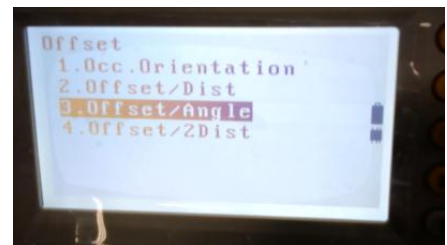

3) Enter the instrument data.

☞ Refer to "6.1 Entering the instrument data"

4) Set the rear view coordinate azimuth.

☞ Refer to "6.3 Rear view azimuth setting"

5) Select "Angle offset" on the <Offset measurement> interface, and enter.

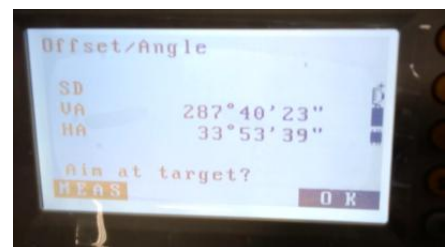

6) Collimate the prism, and press [F1] (Measure) to start distance measurement. When the measurement result is displayed, press [F4] (Stop) to stop measuring.

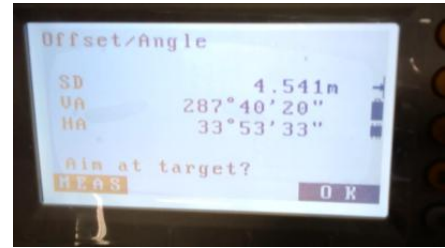

7) Precisely collimate the to-be-measured point and press [F4] (OK) to calculate the distance and angle of the to-be-measured point.

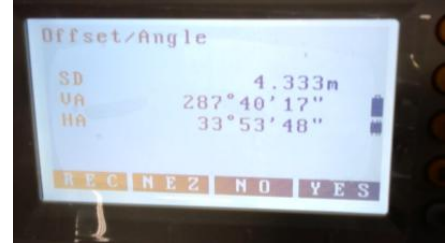

8) Press [F4] (YES) to return to the <Offset measurement> interface.

- Press [F2] (XYZ) to switch distance display to coordinate display.
- Press [F2] (HVD) to switch coordinate display to distance display.
- Press [F3] (NO) to return to the screen that displays the original distance and angle.
- Press [F1] (Record) to save the calculation result.

10.3 Dual-distance offset measurement

Dual-distance offset measurement is to measure two offset points on the same spatial straight line with the hidden to-be-measured points (prism 1 and prism 2), and enter the distance from prism 2 to the to-be-measured point, so as to determine the location of the to-be-measured point.

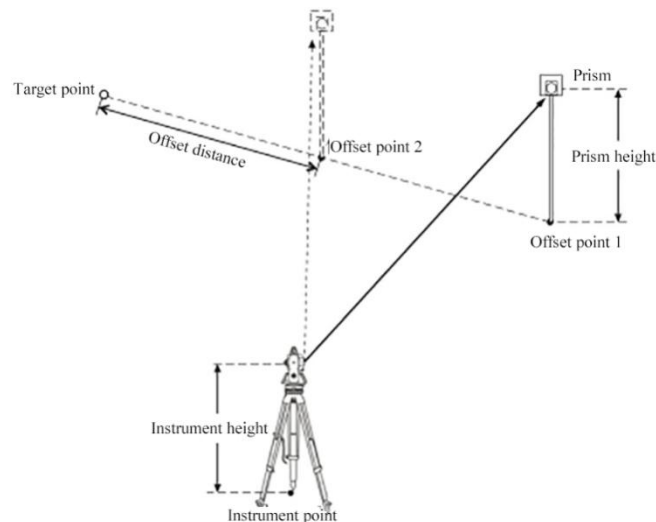

► Steps

1) Set prism 1 and prism 2 on the same spatial straight line with the to-be-measured point; measure the distance from prism 2 to the to-be-measured point.

2) Under the second-page menu in the measurement mode, press [F1] (Procedure) to enter the <Procedure menu>; select "Offset measurement" and enter.

Or directly press [F2] (Offset) on the third page menu in the measurement mode to enter the <Offset measurement>.

3) Enter the instrument data.

 Refer to "6.1 Entering the instrument data"

4) Set the rear view coordinate azimuth.

 Refer to "6.3 Rear view azimuth setting"

5) Select "Dual-distance offset" on the <Offset measurement> interface, and enter.



6) Collimate prism 1, and press [F1] (Measure) to start measuring; when the instrument shows the measurement result, press [F4] (OK) for confirmation.

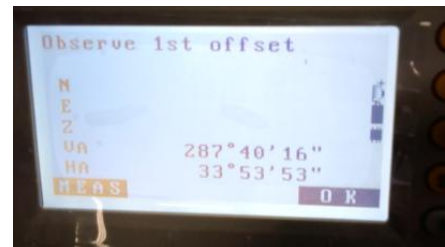

7) Collimate prism 2, and press [F1] (Measure) to start measuring; when the instrument shows the measurement result, press [F4] (OK) for confirmation.

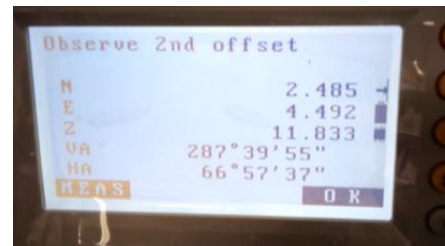

8) Enter the distance from prism 2 to the to-be-measured point, and press [ENT]; coordinates of the to-be-measured point will show on the screen.

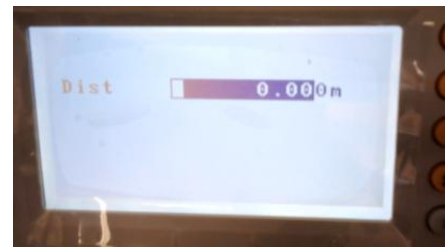

9) Press [F4] (YES) to return to the <Offset measurement> interface.

- Press [F2] (HVD) to switch coordinate display to distance display.

Press [F2] (XYZ) to switch distance display to coordinate display.

- Press [F3] (NO) to return to the screen that displays the original distance and angle.

- Press [F1] (Record) to save the calculation result.

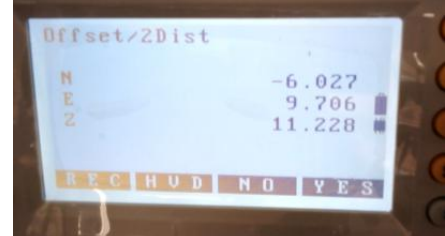

11. Opposite side measurement

Opposite side measurement is to directly measure, without moving the instrument, the slope distance, horizontal distance and vertical difference of multiple target points from a given starting point (P1).

- The finally measured point can be set as the starting point of subsequent measurements.
- The vertical difference between any target point and the starting point can also be displayed as slope.

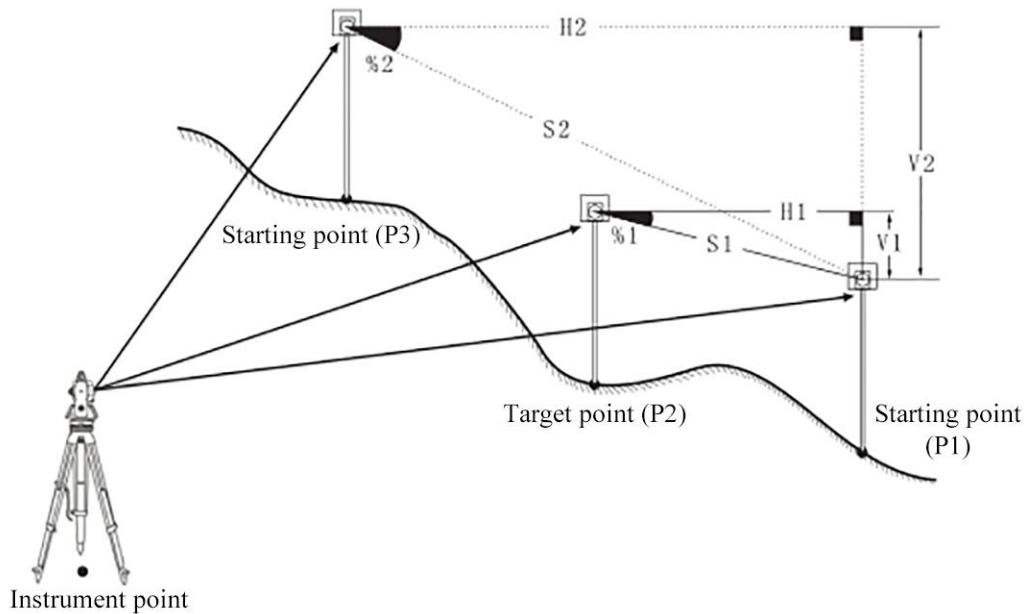

11.1 Multi-point distance measurement

► Steps

1) Enter the second page in the measurement mode.



2) Press [F2] (Procedure) to enter the <Procedure menu> screen.

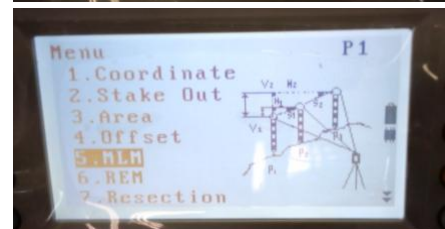

3) Select "Opposite side measurement", and enter.



4) Collimate the starting point, and press [F4] (Measure) to start measuring. When the measured value is displayed, press [F4] (Stop) to stop measuring.

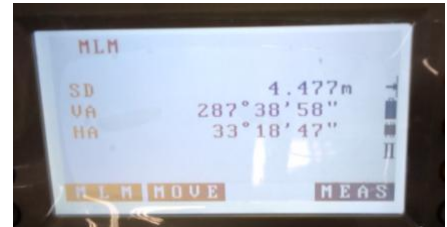

5) Collimate the target point, and press [F1] (Opposite side) to measure the target point. The screen will display the following measurements:

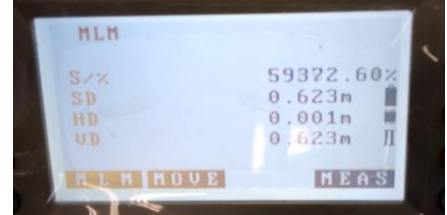

S/%: Slope between the target point and the starting point.

Slope distance: Slope distance between the target point and the starting point.

Horizontal distance: Horizontal distance between the target point and the starting point.

Vertical difference: Vertical difference between the target point and the starting point.

6) Collimate the next target point, and press [F1] (Opposite side) to measure the target point. Repeat the procedure to measure the slope distance, horizontal distance and vertical difference between multiple target points and the starting point.

- Collimate the starting point, and press [F4] (Measure) to re-measure the starting point.
- After measuring a target point, press [F2] (Starting point) to set the point as a new starting point for subsequent measurement.



See "11.2 Changing the starting point"

6) Press [ESC] to end the opposite side measurement.

11.2 Changing the starting point

The finally measured target point can be set as the starting point of subsequent measurement.

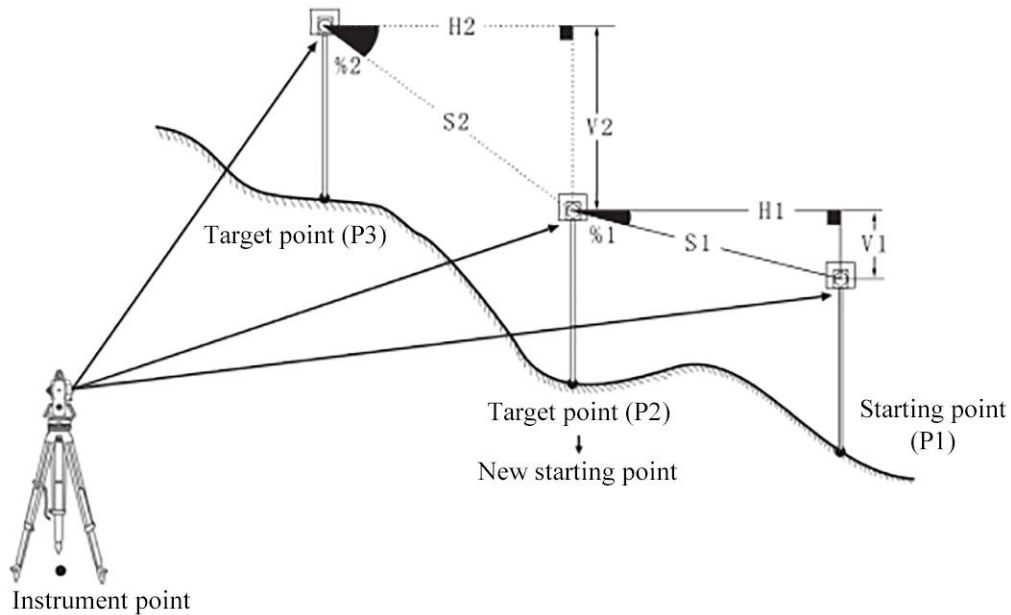

► Steps

1) Follow steps 1-5 in “11.1 Multi-point distance measurement” to measure the starting point and the target point.



2) After measuring a target point, press [F2] (Starting point).

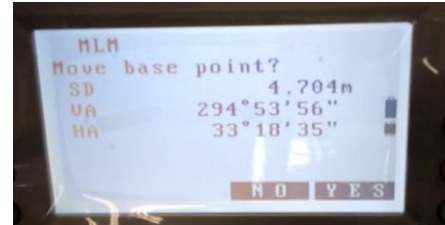

3) Press [F4] (Yes), and the target point is set as the starting point of subsequent measurement. Follow steps 5-6 in “Multi-point distance measurement” to continue opposite side measurement.

12. Remote elevation measurement

Remote elevation measurement is performed for objects on which prism cannot be set, such as height measurement of high-voltage transmission lines, overhead cables, bridges, and so on.

Height can be calculated by using the following formulas:

$$Ht = h1 + h2$$

$$h2 = S \sin \theta z1 \times \text{ctg} \theta z2 - S \cos \theta z1$$

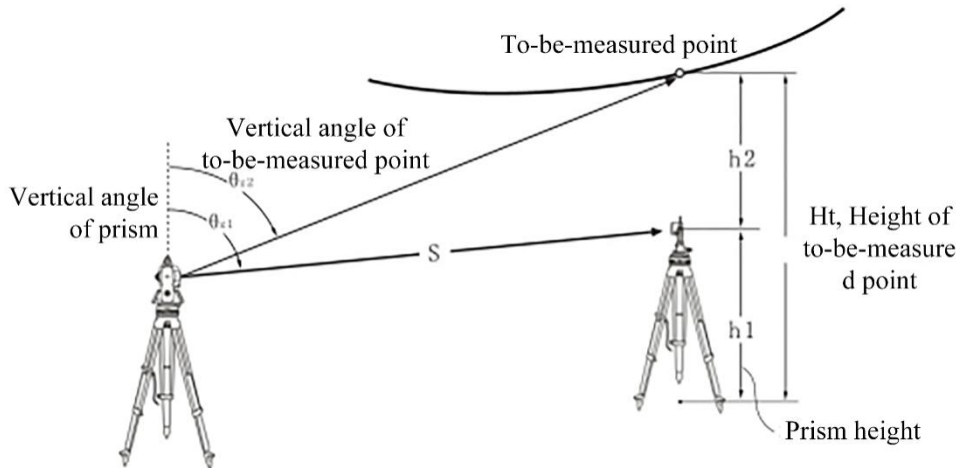

► Steps

- 1) Set a prism right above or below the to-be-measured object, and measure the prism height.
- 2) Enter the second page in the measurement mode.
- 3) Press [F2] (Procedure) to enter the <Procedure menu> screen.
- 4) Select "Remote elevation measurement", and enter.

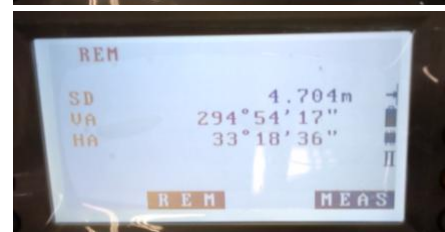
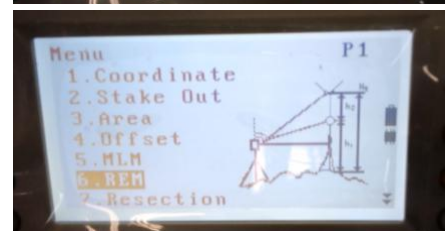
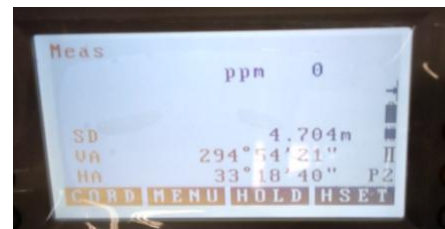

5) Press [F1] (Elevation) and enter the prism height; then press [ENT] for confirmation.



6) Precisely collimate the prism, and press [F4] (Measure) to measure the distance.

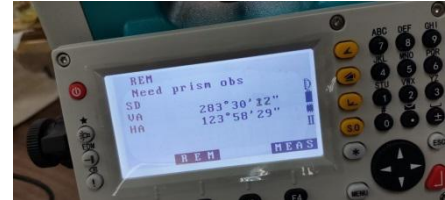

7) Rotate the telescope to collimate the to-be-measured object; press [F2] (Remote elevation); the "height" of the to-be-measured object from the ground will show on the screen of the instrument.



8) Press [F4] (Stop) to stop remote elevation measurement.

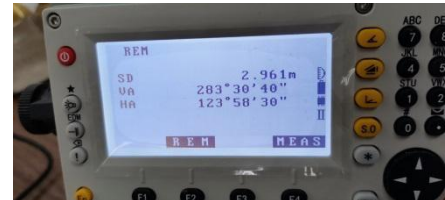

9) Press [ESC] to end remote elevation measurement, and return to the <Procedure menu>.

- Press [F4] (Measure) to re-measure the prism.

13 Point projection

Point projection is to project a coordinate point to a specified baseline; coordinates of the to-be-projected point can be measured or manually input. After projection, the instrument will calculate and display the length and offset distance of the to-be-projected point.

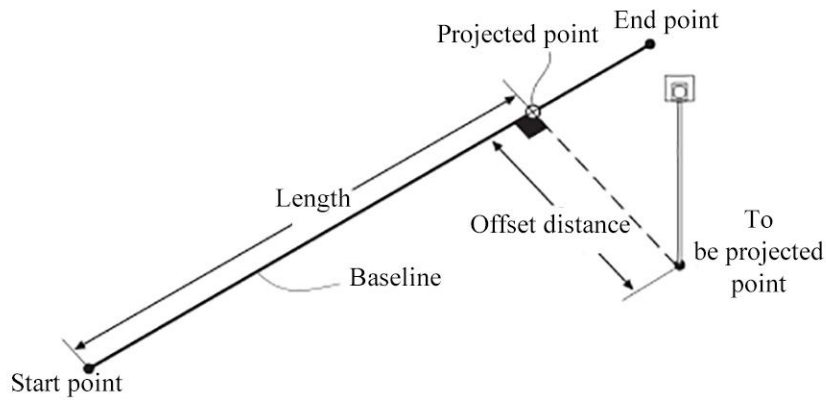

13.1 Definition of baseline

The baseline defined can be used for staking out and measurement of straight line, as well as for point projection.

► Steps

1) Enter the second page in the measurement mode.

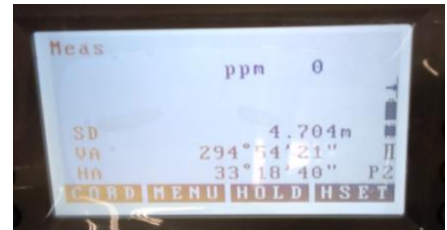

2) Press [F2] (Procedure) to enter the <Procedure menu>, and press [*] to enter the second page of the <Procedure menu>.

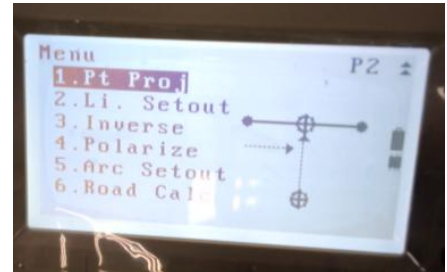

3) Select "Point project" and enter.

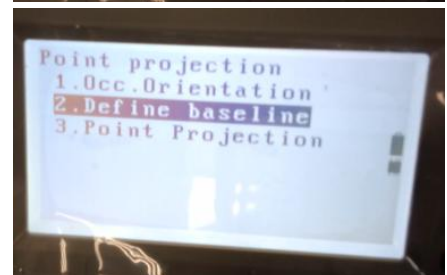

4) Enter the instrument data.

 Refer to “6.1 Entering the instrument data”

5) Select “Defined baseline” and enter.

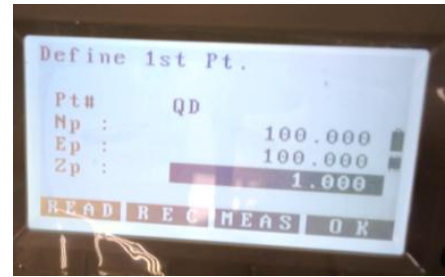

6) Enter the baseline starting coordinate, and press [F4] (OK) for confirmation.

- Press [F1] (Call) to call known coordinate data in the memory.

 Refer to “6.2 Calling known coordinate data in the memory”

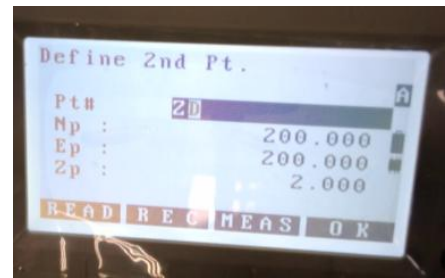

7) Enter the baseline ending coordinate and press [F4] (OK) for confirmation.

- Press [F1] (Call) to call known coordinate data in the memory.

 Refer to “6.2 Calling known coordinate data in the memory”

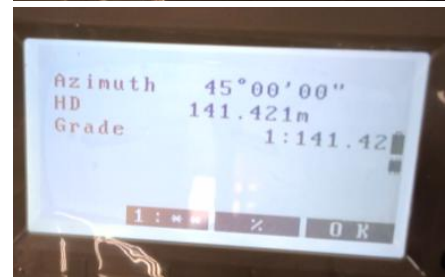

8) Press [F4] (OK) to complete definition of the baseline.

- Press [F2] (1: **) to change the slope displayed to “1: **”, namely vertical difference: horizontal distance”.
- Press [F3] (%) to change the slope displayed to “* %”.

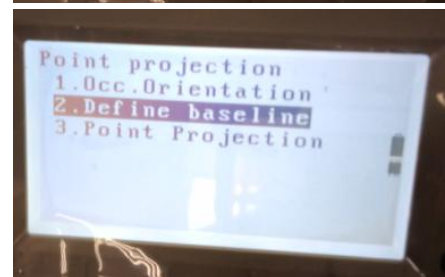

13.2 Point projection

- Before point projection, it is required to define a baseline.

► Steps

1) Definition of baseline

 Refer to “13.1 Definition of baseline”

2) Enter the <Point projection> menu screen.

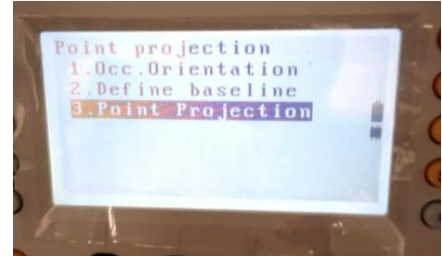

3) Select “Point project” and enter.

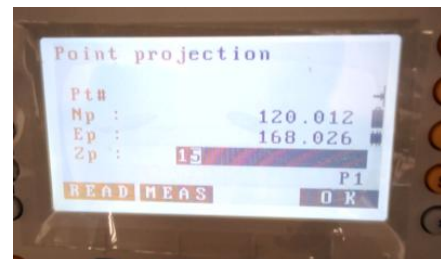

4) Enter coordinates of the to-be-projected point.

- Press [F1] (Call) to call known coordinate data in the memory.

 Refer to “6.2 Calling known coordinate data in the memory”

- Press [F2] (Measure) to determine coordinates of the to-be-projected point.
- To save the coordinate data, press [*] and then [F2] (Record) on the second page menu.

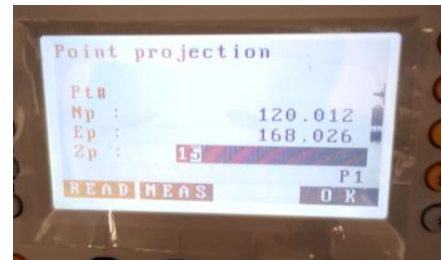

5) Press [F4] (OK) for point projection. The instrument will calculate and display the following values:

- Length: Distance from the starting point along the baseline to the projected point.
- Offset distance: Distance from the to-be-projected point to the projected point on the baseline.
- Vertical difference: Vertical difference between the to-be-projected point and its projected point on the baseline.
- Press [F1] (XYZ) to switch to coordinate display of the projected point.
- Press [F1] (Offset) to switch to distance display of the projected point.
- Press [F2] (Record) to save coordinates of the projected point as known point data.
- Press [F4] (Staking out) to go to staking out measurement of the projected point.

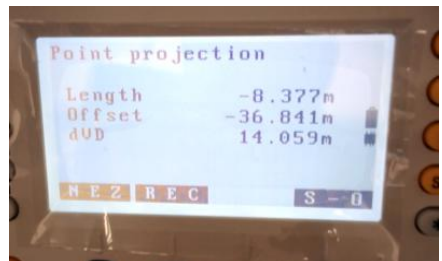

 Refer to “8. Staking out measurement”

6) Press [ESC], and start from step 3) to measure projection of other points.

14. Linear staking out

Linear staking out is performed to determine the location of a known point by measuring its distance from the defined baseline, or to determine the distance from the measured point to the baseline.

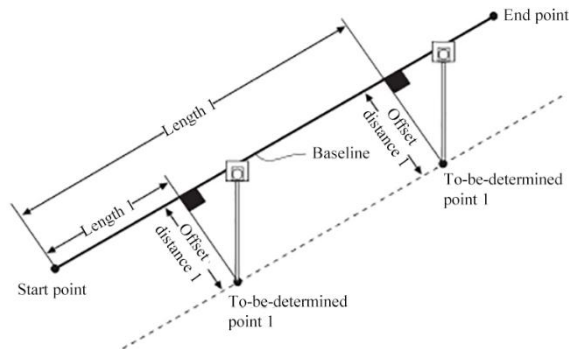

14.1 Definition of baseline

For linear staking out measurement, it is first required to define a baseline. The baseline can be defined by entering coordinates of two points.

- The baseline so defined can be used for linear staking out measurement and projection.

► Steps

1) On the second page menu in the measurement mode, press [F1] (Procedure) to enter the <Procedure menu> and the press [*] to enter the second page of the <Procedure menu>.

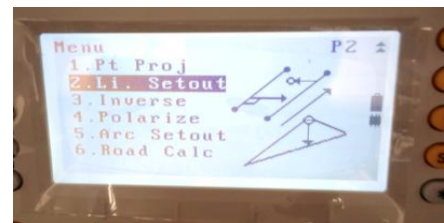

2) Select “Linear staking out”, and enter.

3) Enter the instrument data, and define a baseline.

Refer to steps 5)-7) in “13.1 Definition of baseline”

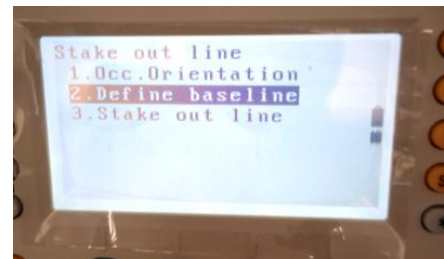

4) Press [F4] (OK) to complete baseline definition, and enter <Linear staking out> for linear staking out measurement.

Refer to “14.2 Linear point staking out” and “14.3 Linear line staking out”

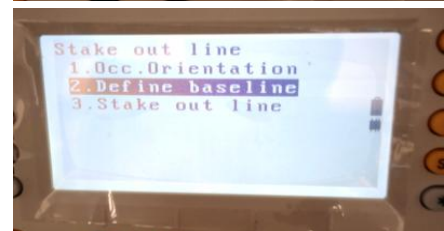

14.2 Linear point staking out

Linear point staking out can be performed based on coordinates of a staking out point that are determined by entering the length and offset distance relative to the defined baseline.

- Before point projection, it is required to define a baseline.

► Steps

1) Enter the <Linear staking out> menu screen.

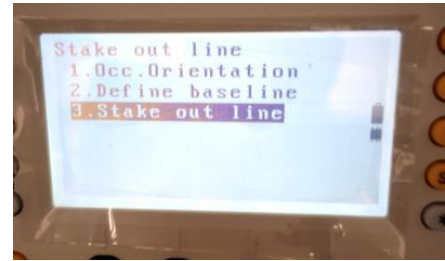

2) Select "Linear staking out", and enter.



3) Select "Point staking out", and enter.

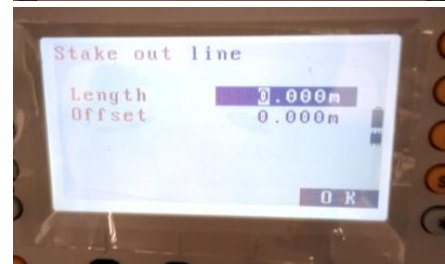

4) Enter the following values:

- Length: Distance from the foot point of the staking out point on the baseline to the starting point of the baseline.
- Offset distance: Distance from the staking out point to its foot point on the baseline.



5) Press [F4] (OK) to calculate and display coordinates of the staking out point.

- Press [F1] (Record) to save the calculated coordinates to the instrument memory as known coordinates.
- Press [F4] (Staking out) for staking out measurement of the staking out point.



 Refer to "8. Staking out measurement"

6) Press [ESC]; repeat the steps above to continue staking out measurement.

14.3 Linear line staking out

Linear line staking out is performed to determine the horizontal and vertical distance of the measured point to the defined baseline.

- Before point projection, it is required to define a baseline.

► Steps

1) Enter the <Linear staking out> menu screen.

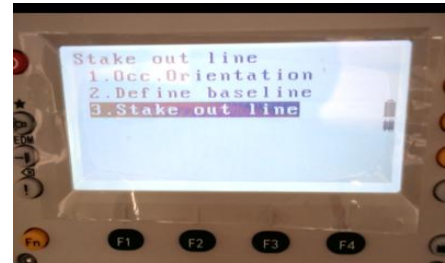

2) Select “Linear staking out”, and enter.

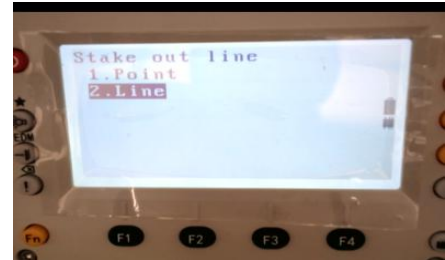

3) Select “Line staking out”, and enter. Enter the offset value.

- Offset distance: Horizontal translation distance of the baseline. When the baseline moves rightwards, the offset distance is positive; or otherwise when it moves leftwards, the offset distance is negative.
- If no offset value needs to be set, go directly to step 4).



4) Collimate the target, and press [F4] (Measure).

The instrument will show the measurement result.

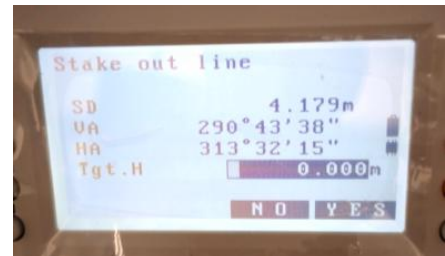

5) Press [F4] (Yes) to confirm the measurement result. At this time, the screen will display the offset value of the measured point from the baseline.

- Offset: It is the offset of a measured point from the baseline. If the value is positive, it means the measured point is on the right side of the baseline; if it is negative, it means the measured point is on the left side of the baseline.
- Higher: It means the measured point is above the baseline.
- Lower: It means the measured point is below the baseline.
- Length: Distance from the foot point of the measured point on the baseline to the starting point of the baseline.
- Press [F3] (No) to re-measure the target.

6) Collimate the next target, and press [F4] (Measure) for baseline measurement.

- Press [F3] (Record) to save the measurement result.

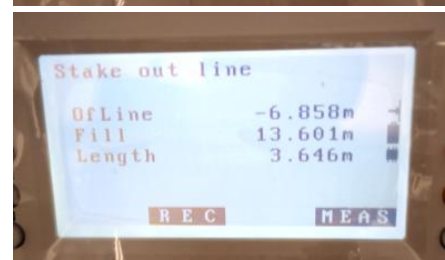

15. Reverse calculation with coordinates

Reverse calculation with coordinates is performed to calculate the distance and azimuth of the line segment connecting the starting and ending points by entering coordinates of the two points.

Input value

Coordinates of the starting point: N_0, E_0, Z_0

Coordinates of the ending point: N_1, E_1, Z_1

Output value

Azimuth Angle

Horizontal distance, vertical difference

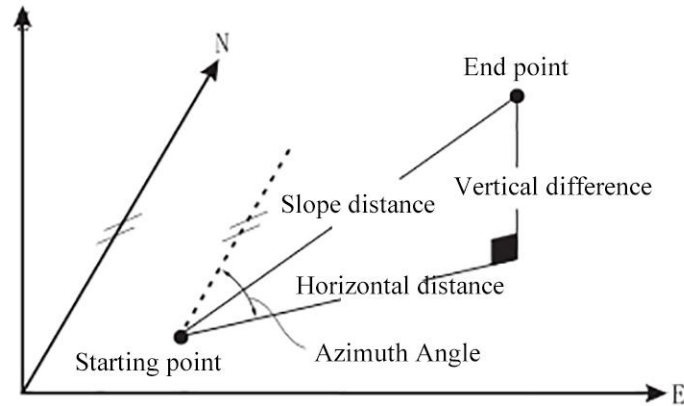

► Steps

1) Enter the second page in the measurement mode.

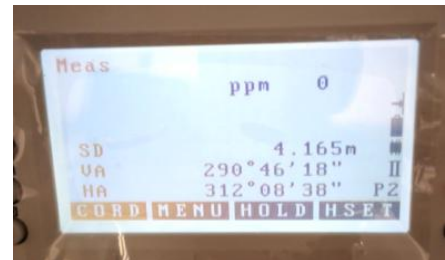

2) Press [F2] (Procedure) to enter the <Procedure menu>, and press [*] to enter the second page of the <Procedure menu>.

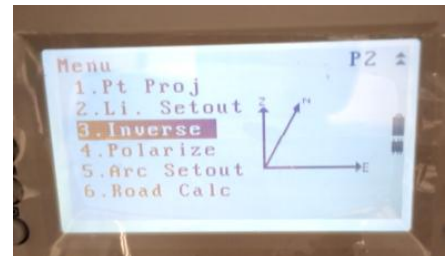

3) Select "Reverse calculation with coordinates"

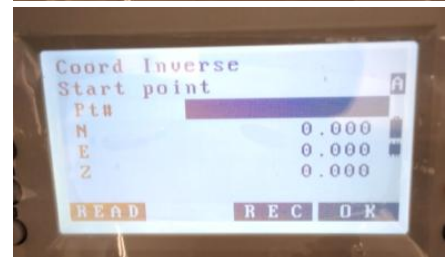

4) Enter coordinate data of the starting point, and press [F4] (OK) for confirmation.

- Press [F1] (Call) to call known coordinate data in the memory.

 Refer to “6.2 Calling known coordinate data in the memory”

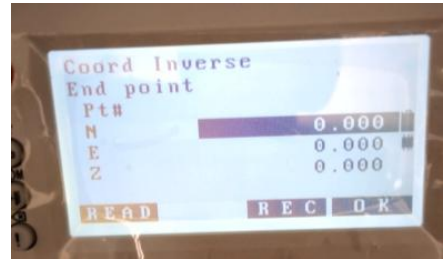

5) Enter coordinate data of the ending point, and press [F4] (OK) for confirmation.

- Press [F1] (Call) to call known coordinate data in the memory.

 Refer to “6.2 Calling known coordinate data in the memory”

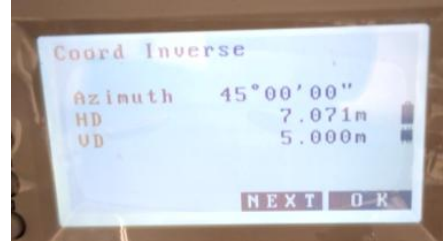

6) Press [F4] (OK) to end reverse calculation with coordinates, and return to the procedure menu.

- Press [F3] (Next), and repeat steps 4) ~5).

16. Polar coordinate calculation

Polar coordinate calculation is performed to determine coordinates of the ending point by entering coordinates of the starting point, and azimuth and distance of the target point.

Input value

Coordinates of the starting point: N_0, E_0, Z_0

Azimuth Angle

Distance

Output value

Coordinates of an unknown point:
 N_1, E_1, Z_1

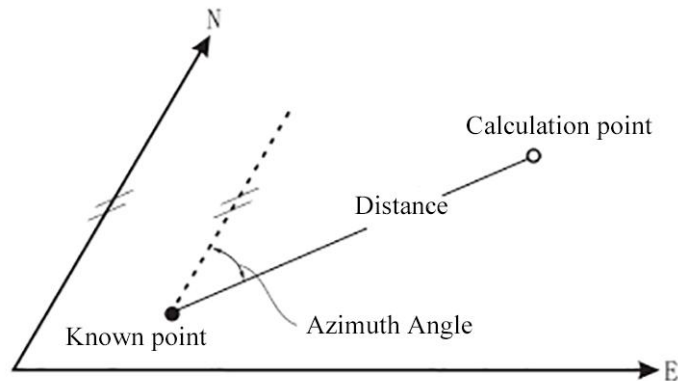

► Steps

1) Enter the second page in the measurement mode.

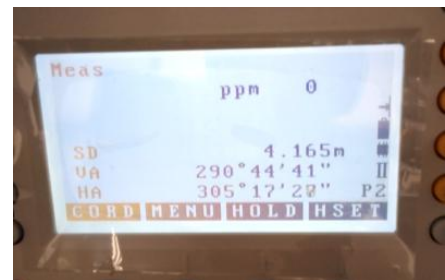

2) Press [F2] (Procedure) to enter the <Procedure menu>, and press [*] to enter the second page of the <Procedure menu>.

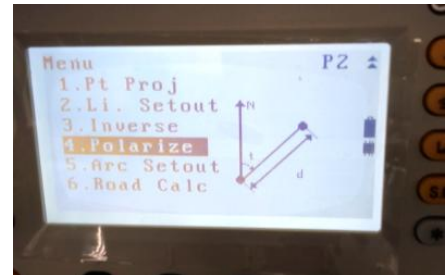

3) Select "Polar coordinate calculation", and enter.

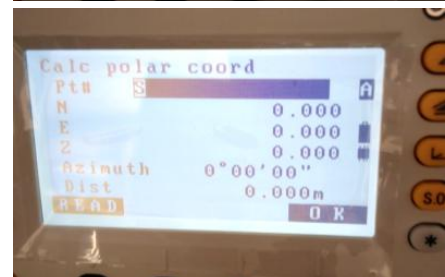

4) Enter coordinate data of the starting point, the azimuth and distance between the two points.

- Press [F1] (Call) to call known coordinate data in the memory.

 Refer to “6.2 Calling known coordinate data in the memory”

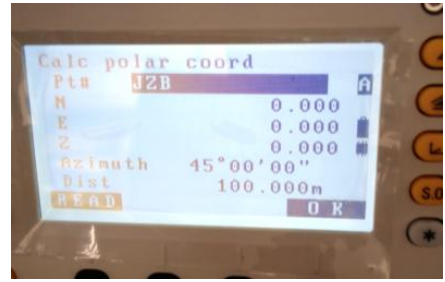

5) Press [F4] (OK) to confirm the input, and the instrument will calculate coordinates of the unknown point.

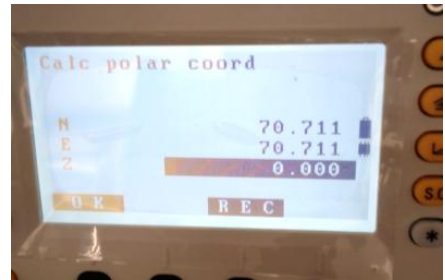

6) Press [F1] (OK) to end polar coordinate calculation, and return to the <Procedure menu> screen.

17. Arc staking out

Arc staking out is performed for staking out measurement of an arc.

17.1 Two-point and radius arc staking out

Two-point and radius arc staking out are performed based on the starting point, ending point and radius of a known arc.

► Steps

1) Enter the second page in the measurement mode.



2) Press [F2] (Procedure) to enter the <Procedure menu>, and press [*] to enter the second page of the <Procedure menu>.

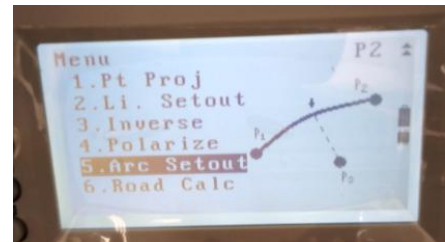

3) Select "Arc staking out", and enter to perform instrument orientation.

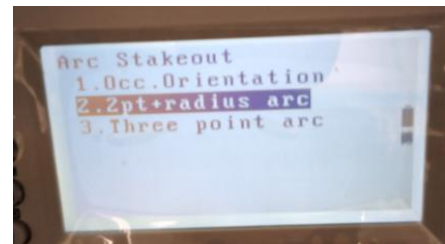

4) Enter the instrument data.

Refer to steps 4)-6) in "6.1 Entering the instrument data"

5) Set the rear view coordinate azimuth.

Refer to steps 2)-5) in "6.3 Rear view azimuth setting"

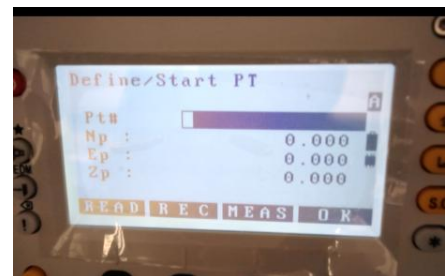

6) Select "2-point + radius arc", and enter.

7) Enter coordinates of the arc starting point, and press [F4] (OK).

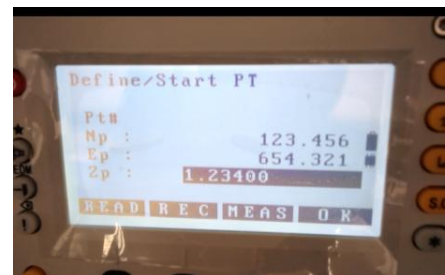

8) Enter coordinates of the arc ending point, and press [F4] (OK).

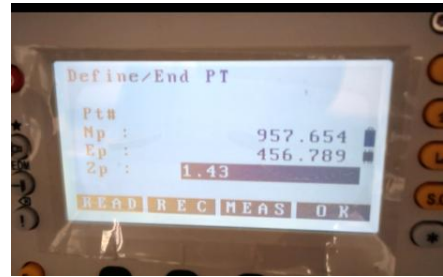

9) Enter the arc radius, collimate the prism, and press [F4] (Measure).

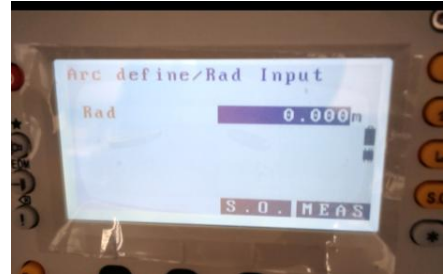

10) After distance measurement, the instrument will show the measurement result. Rotate the instrument alidade until the displayed “staking out angle difference” turns to “0°”, and set a prism in the collimation direction. Press [F1] (Measure) to continue measuring.

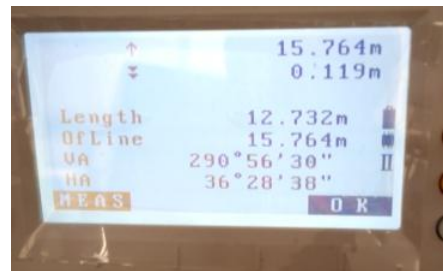

▼: Move the prism downwards

▲: Move the prism upwards

α: Move the prism toward the instrument

↑: Move the prism away from the instrument

11) The staking out point is reached when the instrument shows “0m” in the first two lines; press [F4] (OK) to end staking out, and return to the <Arc staking out> screen.

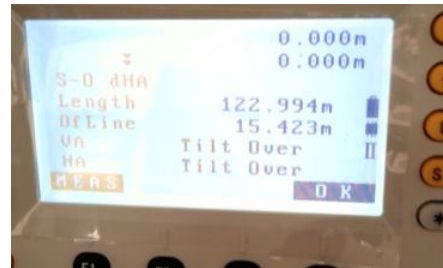

Tip:

- When the staking out angle difference turns to 0° or within the arc angle range, nothing will show in the “staking out angle difference” line.

17.2 Three-point arc staking out

Three-point arc staking out is performed based on the starting point, ending point and middle point of a known arc.

► Steps

1) Enter the second page in the measurement mode.

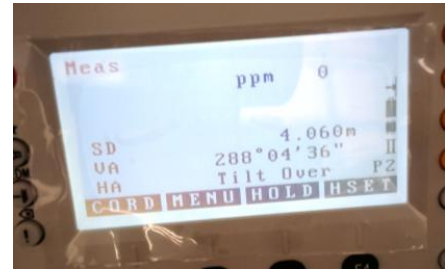

2) Press [F2] (Procedure) to enter the <Procedure menu>, and press [*] to enter the second page of the <Procedure menu>.

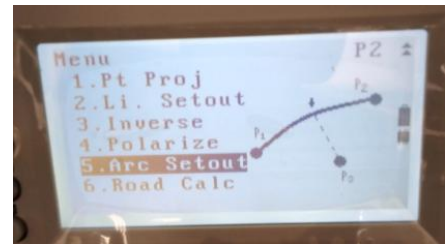

3) Select "Arc staking out", and enter to perform instrument orientation.

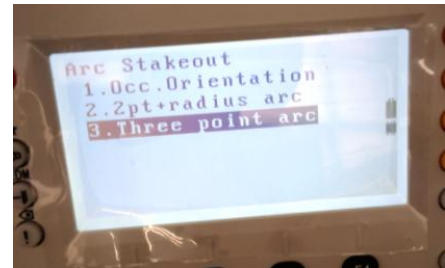

4) Enter the instrument data.

 Refer to steps 4)-6) in "6.1 Entering the instrument data"

5) Set the rear view coordinate azimuth.

 Refer to steps 2)-5) in "6.3 Rear view azimuth setting"

6) Select "3-point arc", and enter.

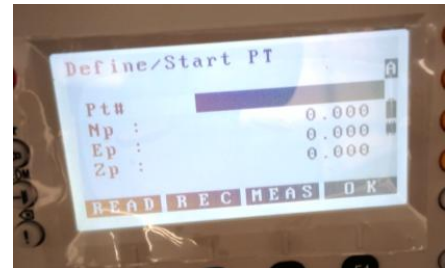

7) Enter coordinates of the arc starting point, and press [F4] (OK).

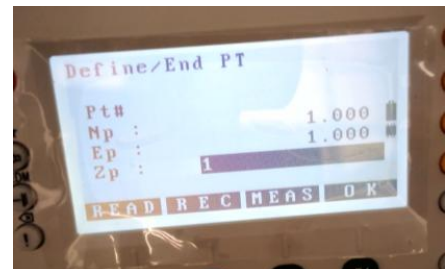

8) Enter coordinates of the arc ending point, and press [F4] (OK).

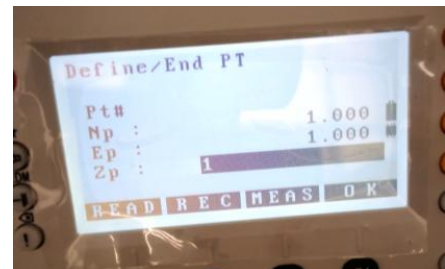

9) Enter coordinates of the arc middle point, and press [F4] (OK).

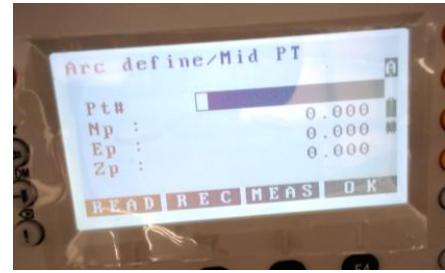

10) Enter the arc length and offset distance; press [F4] (OK).

- Press [F2] (Equal arc) for switching between input length and arc length.
- Press [F2] (Equal chord) for switching between input chord and arc length.

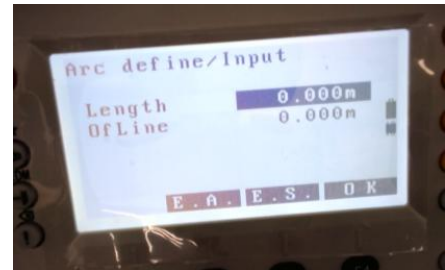

11) Collimate the prism and press [F1] (Measure) to measure the distance; after distance measurement, the instrument will show the measurement result. Rotate the instrument alidade until the displayed "staking out angle difference" turns to "0°", and set a prism in the collimation direction. Press [F1] (Measure) to continue measuring.

▼: Move the prism downwards

▲: Move the prism upwards

α: Move the prism toward the instrument

↑: Move the prism away from the instrument



12) The staking out point is reached when the instrument shows "0m" in the first two lines; press [F4] (OK) to end staking out, and return to the <Arc staking out> screen.



18. Road measurement

The road measurement function is mainly used for calculation and staking out measurement of planar points for roads in civil surveying. All function menus are operated following the steps of instrument setup, calculation, recording, and staking out measurement.

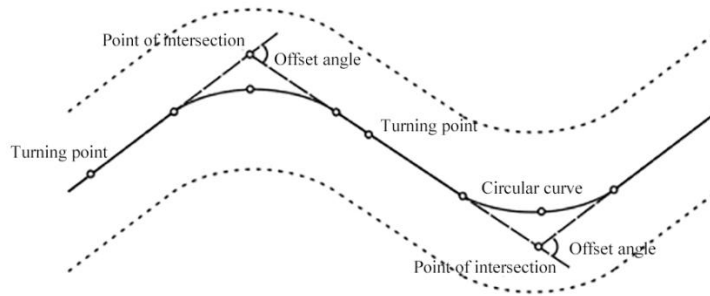

18.1 Entering road parameters (horizontal)

Enter horizontal curve elements and set starting mileage of a road for road calculation.

► Steps

1) Enter the second page in the measurement mode.



2) Press [F2] (Procedure) to enter the <Procedure menu>, and press [*] to enter the second page of the <Procedure menu>.

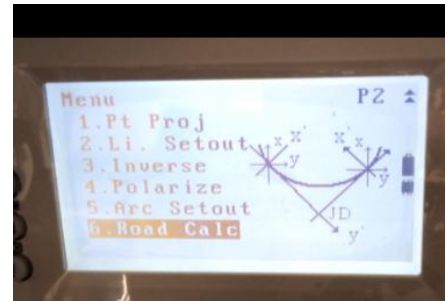

3) Select "Road calculation", and enter.

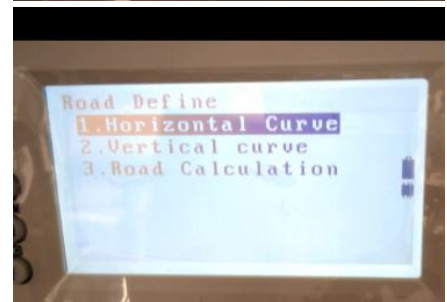

4) Select "Enter parameters", and enter.

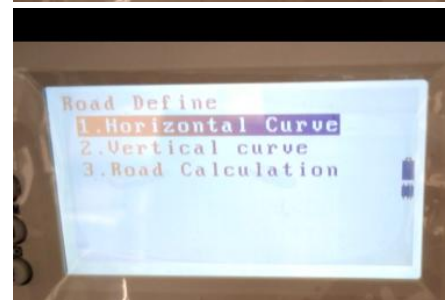

5) Select "Horizontal staking", and enter.

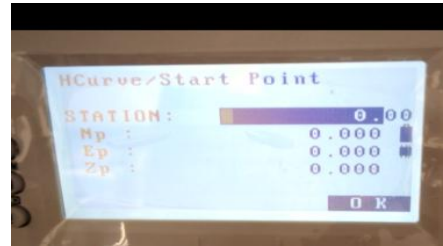

6) Enter the mileage and coordinates of the starting point, and press [F4] (OK).

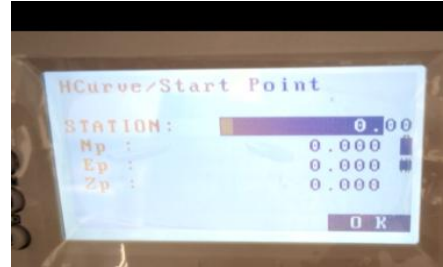

7) The instrument will go to the line edit screen, where you may add a desired line type as needed. Press [F2] (Straight line) to add straight line.

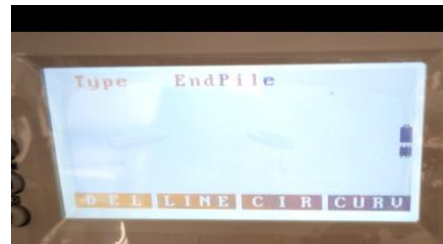

8) Enter the length and azimuth of the straight line, and press [F4] (OK).

- Press [F3] (Ending point) to view coordinates of the ending point.

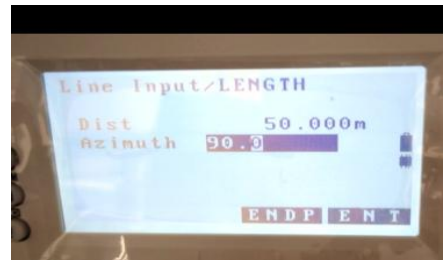

9) When the instrument returns to the line edit screen, straight line is included in the list; press [F3] (Circular curve) to add circular curve.

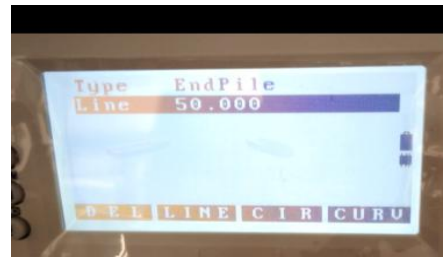

10) Enter the length, radius and azimuth of the circular curve; press the arrow keys to select the rotating direction (left, right) of the curve, and then press [F4] (OK).

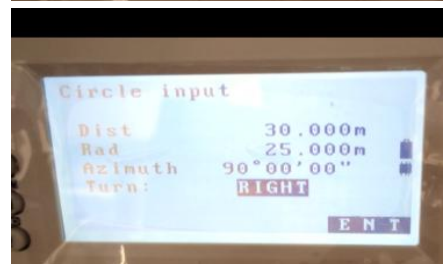

11) When the instrument returns to the line edit screen, circular curve is included in the list; press [F4] (Staking) to add easement curve.

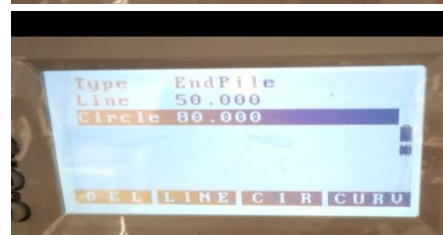

12) Enter the length, radius and azimuth of the easement curve; press the arrow keys to select the rotating direction (left, right) of the curve and the orientation (entering, leaving); then press [F4] (OK).



13) When the instrument returns to the line edit screen, the easement curve is included in the list.



14) Press the arrow keys to move the cursor; press [F1] (Delete) to delete the line type selected by the cursor. Repeat steps 4~9 until all required line types are added; then press [ESC] to return to the previous menu.

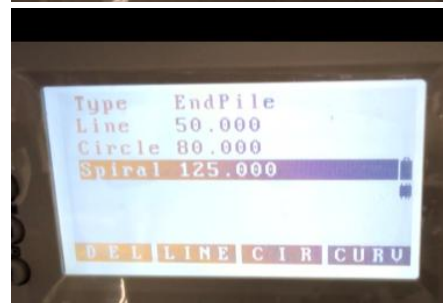

18.2 Entering road parameters (vertical)

Enter vertical curve elements and set starting mileage of a road for road calculation.

► Steps

1) When the instrument displays the “Road calculation” menu, press digit key “1” (Enter parameters), and enter.

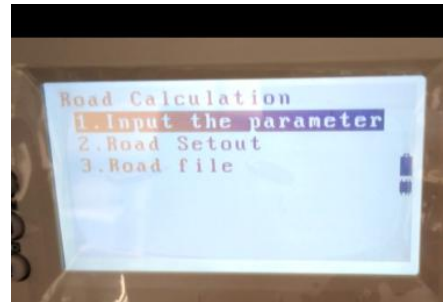

2) Select “Vertical staking”, and enter.

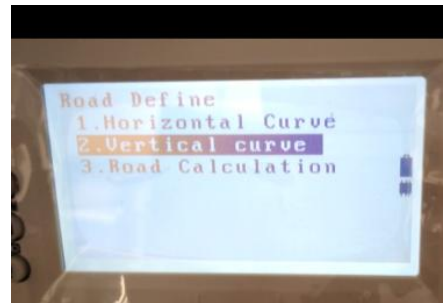

3) When the instrument displays the line edit screen, press [F4] (Add).



4) Enter the starting mileage, height and length of vertical staking; then press [F4] (OK).



5) When the instrument returns to the line edit screen, the edited vertical curve is included in the list.



6) Repeat step 3 and 4 until all vertical curves are added; then press [F1] (First) to point the cursor to the first edited vertical curve; press [F2] (Final) to point the cursor to the final edited vertical curve. Press [F3] (Delete) to delete the vertical curve that the cursor currently points to from the list. After all required vertical curves are added, press [ESC] to go back to the previous menu.



18.3 Road calculation

Enter the horizontal and vertical staking for road calculation.

► Steps

1) Make sure the instrument is in the road staking menu, and horizontal/vertical staking has been input; select “Road calculation”, and enter.

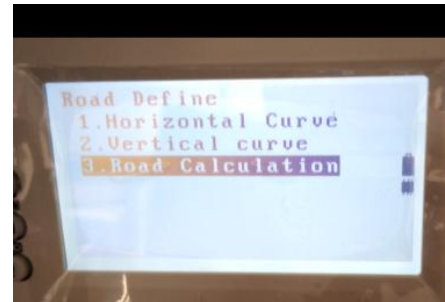

2) Enter the road spacing.

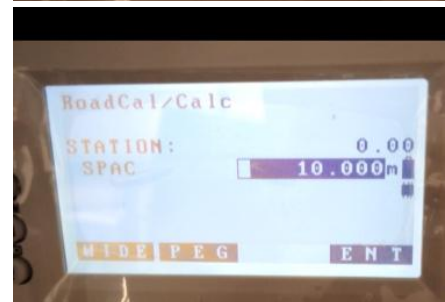

3) Press [F2] (Staking), and the instrument will display the staking list screen; press [F4] (Add).



4) Enter the starting mileage, width from the left to the right and the height, press [F4] (OK).

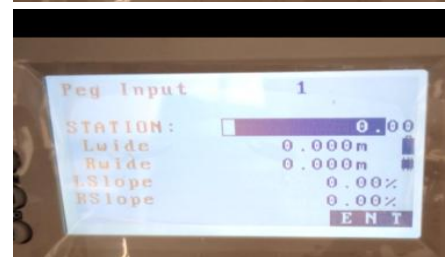

5) The instrument shows the staking edit screen, on which the edited staking is included in the list. Repeat steps 3 and 4 until all stakes are added; press [F1] (First) to point the cursor to the first added stakes; press [F2] (Final) to point the cursor to the final added stake. Press [F3] (Delete) to delete the stake that the cursor currently points to from the list. After all desired stakes are added, press [ESC] to return to the previous menu.

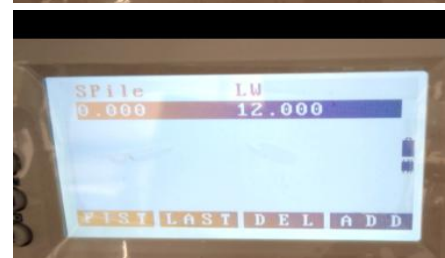

6) Press [F4] (OK) to start road calculation. Points obtained through calculation by the instrument are automatically saved to the selected coordinate file; when calculation is completed, the instrument will automatically go back to the parameter menu.

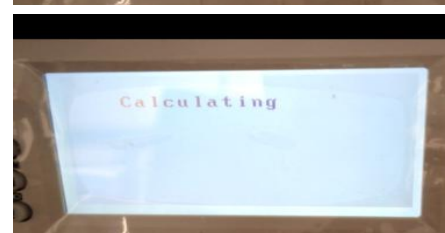

18.4 Road staking out

Points that obtained through road calculation and stored in the instrument are called for staking out.

► Steps

1) Make sure the instrument is displaying the road staking menu and has completed road calculation.

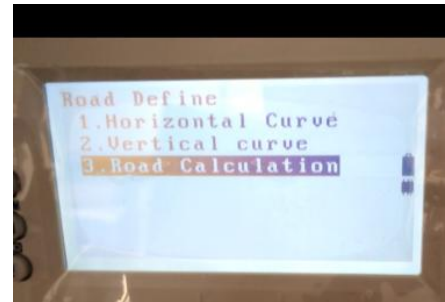

2) Press [ESC] to return to the road measurement menu; press digit key "2" to start road staking out.

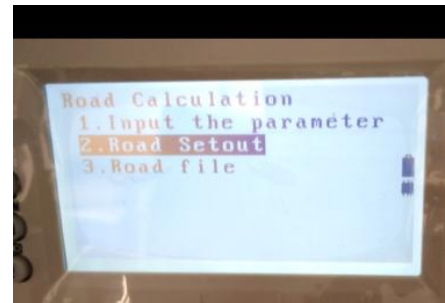

3) After setting the instrument and the rear view point, call points obtained through road calculation and stored in the instrument for staking out.

 For staking out methods, refer to "8 Staking out measurement"

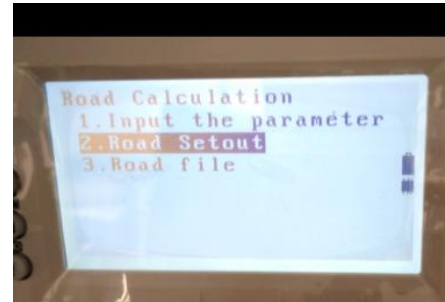

4) Select "Browse road data" to view road data obtained through calculation.

- Press [F1] (↑ ↓. P), and then press [▲] / [▼] to display the previous or next page.
- Press [F1] (↑ ↓. P), and then press [▲] / [▼] to display the previous or next page.
- Press [F2] (First point) to move the cursor to the first point on the first page.
- Press [F3] (Final point) to move the cursor to the final point on the final page.
- Press [F4] (Search) to enter the road data search screen; enter the number of a to-be-searched point to search the point; the search may last long if there is a great quantity of known data.

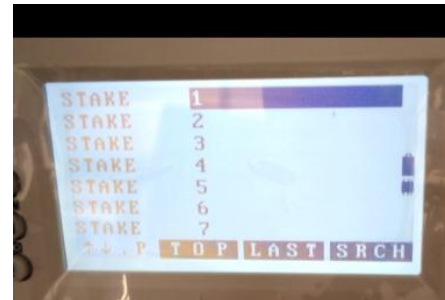

5) Select a desired point number, and then press [ENT]; details of corresponding data will show. The screen on the right shows recorded coordinate data.

- Press [F1] (Previous) to display the previous recorded data.
- Press [F2] (Next) to display the next recorded data.



18.5 Road file editing

Edit a file containing road data.

► Steps

1) When the instrument displays the “Road calculation” menu, select “Road file” and enter.

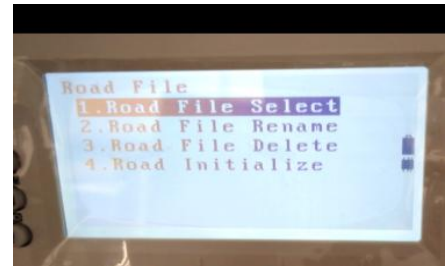

2) Select “Select road file” to go to the folder where data of the current job are stored.

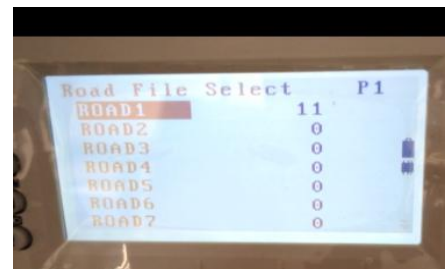

3) Select “Rename road file” to rename the currently selected file. Enter a name, and press [ENT] for confirmation.

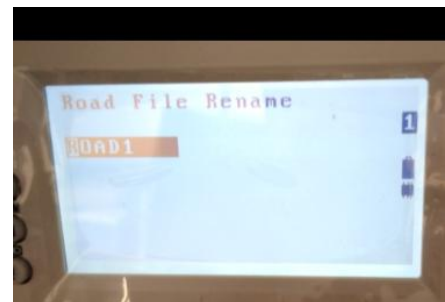

4) Select “Delete road file” to delete a road file; use the up and down arrow keys to move the cursor, and press [ENT] for selection.

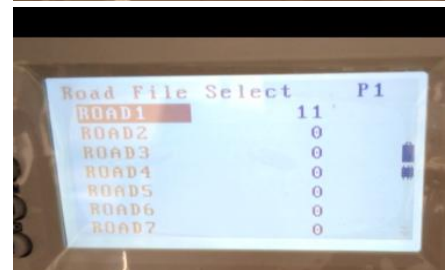

5) Press [F4] (Yes) to confirm the deletion; or press [F3] (No) to cancel the deletion.

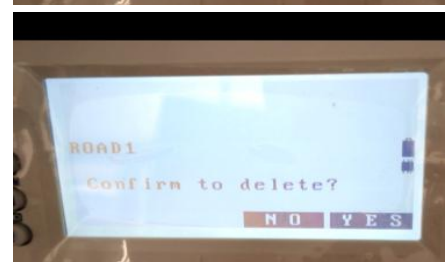

6) Select “Road initialization” to delete all road data.

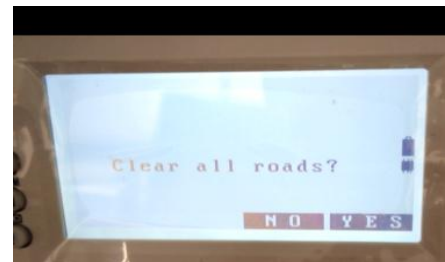

19. Saving coordinates

Save measurement data, instrument data and flag data to the current file under the Save data menu.

☞ Refer to “21.1 File selection”

- The instrument memory may store measurement data of up to 120,000 points.



Tip:

- Upon saving data of a point that has a number already existing in the memory, the instrument screen will show as follows.

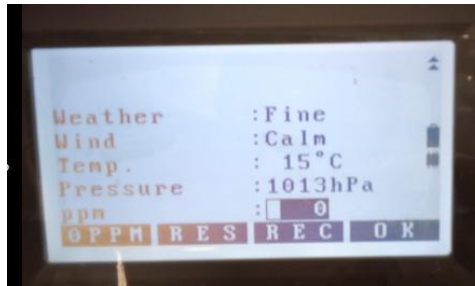

Press [F4] (Yes) to override the original point data with the new point data.

Press [F3] (No) to enter a new point number and save the data under the new point.

Press [F1] (Add) to save new point data under the same point number, without overriding the original point data.

19.1 Save instrument data

Instrument data entered during measurement can be saved to the current file.

- Saved instrument data include: instrument coordinates, point numbers, instrument height, code, observer, observing date, observing time, weather condition, wind force, temperature, atmospheric pressure and meteorological correction, among others.
- If data of the current instrument are not saved to the current file, data of the previous instrument are used.

► Steps

1) Enter the third page in the measurement mode.

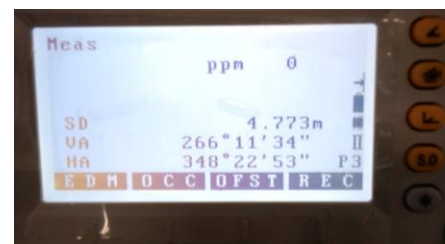

2) Press [F4] (Record) to enter the <Record> menu.

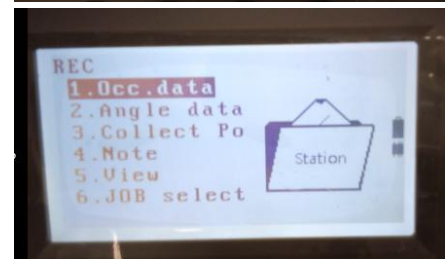

3) Select “Instrument data”, and enter.

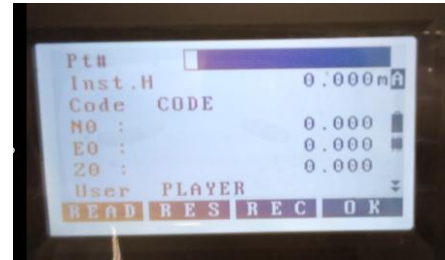

4) Enter the following values.

- ① Instrument coordinates
- ② Point number
- ③ Instrument height
- ④ Code
- ⑤ User
- ⑥ Weather
- ⑦ Wind
- ⑧ Temperature
- ⑨ Atmospheric pressure
- ⑩ Atmospheric correction

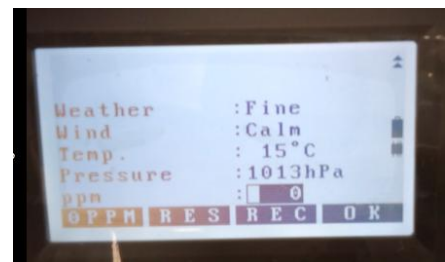
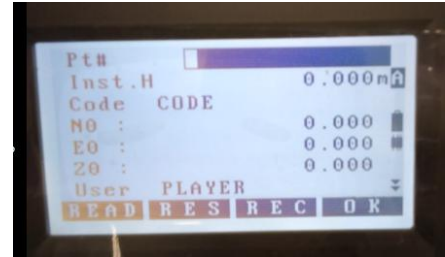

- Press [F1] (0ppm) to set the meteorological correction to “0”, and set the temperature and atmospheric pressure to corresponding default values.

5) Verify the entered data, and then press [F3] (Record) to save the data.



Tip:

- The increment step of point numbers automatically generated by instrument is 1.
- The maximum input length of a point number is 14 characters.
- The maximum input range of the instrument is $-9999.999 \sim 9999.999$.
- For codes and user names, the maximum length of is 16 characters.
- Options for weather setting: Sunny, Cloudy, Rainy, Heavily rainy, Snowy.
- Options for wind force setting: No wind, Breeze, Low wind, High wind, Gale.
- The input range of temperature is $-30 \sim 60^{\circ}\text{C}$, at the step of 1°C .
- The input range of atmospheric pressure is 500~1400 mbar, at the step of 1 mbar (namely 375~1050mmHg, and 1mmHg for each step).
- The input range of meteorological correction is $-499 \sim 499\text{ppm}$.

19.2 Save angle data

Angle data obtained through measurement can be saved to the current file.

- You may use the (Auto) function to conveniently observe and save angle data.

► Steps

1) Enter the third page in the measurement mode.



2) Press [F4] (Record) to enter the <Record> menu.

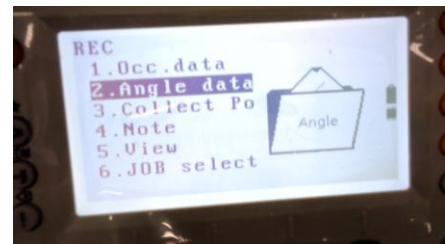

3) Select "Angle data" and collimate a target point; the real-time angle value will show on the screen.



4) Press [F4] (Record), and enter the following values.

- ① Point number
- ② Target height
- ③ Code



5) Verify the entered data, and then press [F1] (OK) to save the data.

6) Collimate the next target point, and repeat steps 4)-5) to continue measuring.

- Press [F1] (Auto) to automatically complete angle measurement and save the measurement result; this function is particularly convenient when it is not required to change the automatically generated point number, code and target height.

7) Press [E s c] to end measurement, and return to the <Record> menu screen.

19.3 Save distance data

Distance data obtained through measurement can be saved to the current file.

► Steps

1) Enter the third page in the measurement mode. Press [F4] (Record) to enter the <Record> menu.



2) Select "Distance and coordinates", and enter.

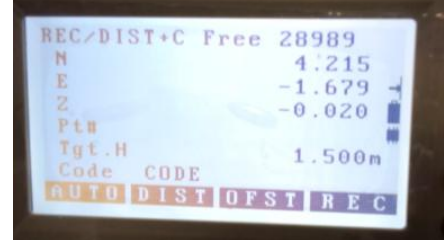

3) Collimate a target point, and press [F2] (Distance measurement) to measure the distance. When the instrument displays the measurement result, press [F4] (Stop) to end the measurement.

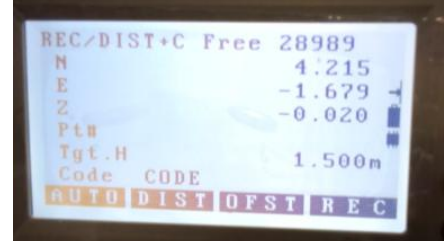

4) Press [F4] (Record), and enter the following values.

- ① Point number
- ② Target height
- ③ Code

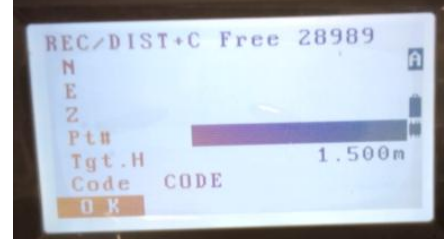

5) Verify the entered data, and then press [F1] (OK) to save the data.

6) Collimate the next target point, and repeat steps 3)-5) to continue measuring.

- Press [F1] (Auto) to automatically complete angle measurement and save the measurement result; this function is particularly convenient when it is not required to change the automatically generated point number, code and target height.

7) Press [E s c] to end measurement, and return to the <Record> menu screen.



Tip:

- Once data are recorded, (Record) displayed will disappear, so as to prevent repeated recording.

19.4 Save flag data

Flag data entered during measurement can be saved to the current file.

► Steps

1) Enter the third page in the measurement mode.



2) Press [F4] (Record) to enter the <Record> menu.

- The current file name is shown on the screen.

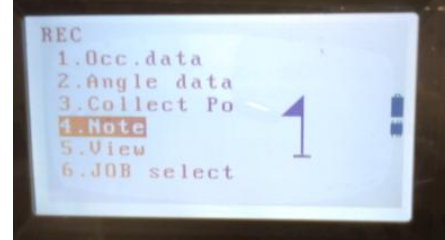

3) Select "Flag", and enter.



4) Enter the flag content.



5) Verify the entered data; then press [F1] (OK) to save the data, and return to the <Record> menu.



Tip:

- The maximum length of flag data is 60 characters.

19.5 Data search

Distance data obtained through measurement can be saved to the current file.

- Point numbers can be used to search corresponding data in the current file, but flag data cannot be searched out.
- This function cannot be used to access any known data that have been entered in advance.

► Steps

1) Enter the third page in the measurement mode.



2) Press [F4] (Record) to enter the <Record> menu.

- The current file name is shown on the screen.

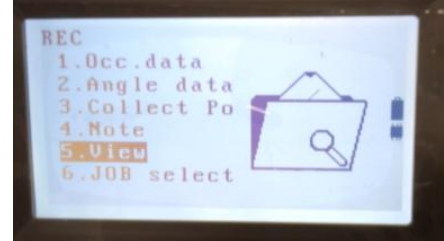

3) Select "Data search", and enter.

- Press [F1] (↑↓ P), and then press [▲] / [▼] to display the previous or next page.
- Press [F1] (↑↓ P), and then press [▲] / [▼] to display the previous or next page.
- Press [F2] (First point) to move the cursor to the first point on the first page.
- Press [F3] (Final point) to move the cursor to the final point on the final page.
- Press [F4] (Search) to go to the coordinate data search screen, and enter the point to be searched for searching; if there is a great quantity of known data, the search will last long.

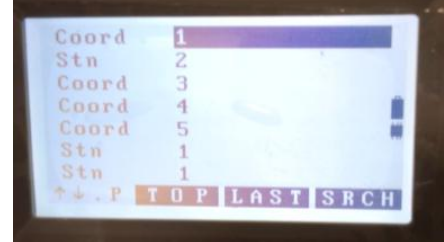

4) Select a desired point number, and then press [ENT]; details of corresponding data will show. The screen on the right shows recorded coordinate data.

- Press [F1] (Previous) to display the previous recorded data.
- Press [F2] (Next) to display the next recorded data.

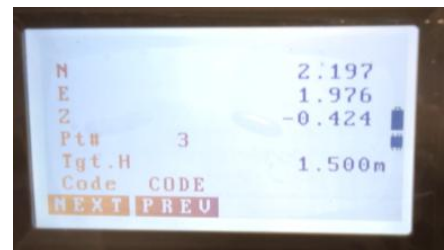

5) Press [E s c] to go back to the point number list screen; press [E s c] again to end measurement and return to the <Record> menu.



Tip:

- When there are multiple points of the same point number in the file, the instrument will only search out data of the latest saved point.

20. File operation

20.1 File selection

File selection includes selection of the current file and the coordinate search file. The current file is where data are saved, while the coordinate search file is used for searching and calling coordinates.

- There are totally 20 files for selection. The factory default name of the current file is "JOB1".
- The 20 files are respectively named "JOB1"~"JOB20". The names can be modified as needed.
- You may also set the scale factor of each file, but only scale factor of the current file can be modified.

Current file

Current file is the file that is currently used to save measurement result, instrument data, known point data, flag data and coordinate data, among others.

 For saving known point data, refer to "6 Input and delete known coordinates"

Coordinate search file

Coordinate data in a coordinate search file can be called for use during coordinate measurement, resection measurement, staking out measurement and other jobs.

Scale correction

Calculate the horizontal distance and coordinates based on measured slope distance. If a scale factor is set, the scale will be corrected during calculation:

Corrected horizontal distance s = measured horizontal distance S × scale factor $S.F$

► Steps

1) Enter the memory mode.

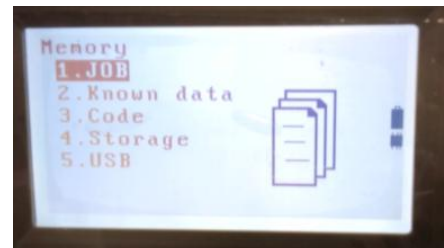

2) Select "File" to enter the <File> menu.

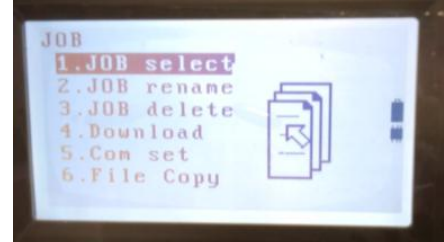

3) Select “File selection” to enter the <File selection> menu.

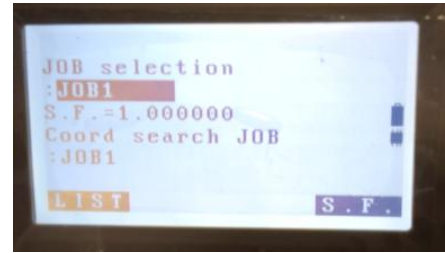

4) Press [F1] (List) to show a list of file names.

- You can also select a file by pressing [◀] or [▶].
- The number on the right side of a file name represents the record number of the file saved to the file.

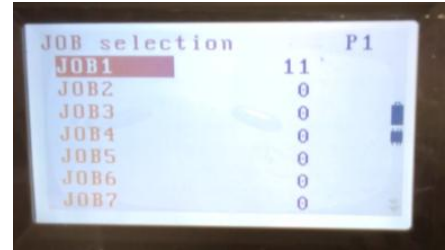

5) Move the cursor to the desired file name, and press [ENT] to select the file as the current file; then return to the <File selection>screen.

6) Press [F4] (S.F.) to enter the scale factor input screen.

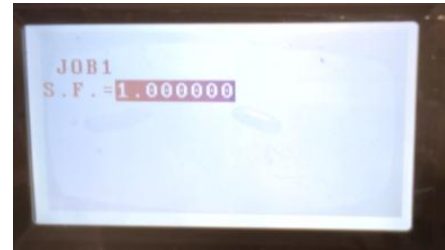

7) Enter the scale factor of the current file, and press [ESC] to return to the <File selection> screen.

8) Move the cursor to “Coordinate search file”.

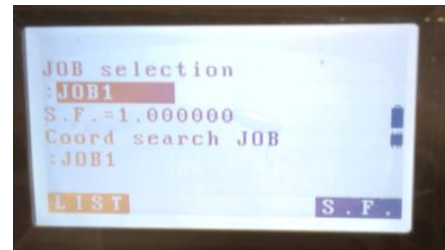

9) Press [F1] (List) to show a list of file names.

- You can also select a file by pressing [◀] or [▶].
- The number on the right side of a file name represents the record number of the file saved to the file.

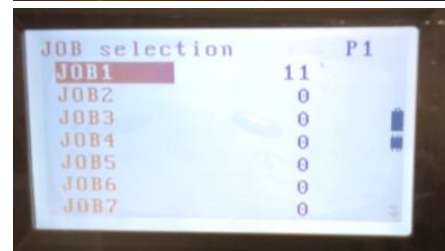

10) Move the cursor to the desired file name, and press [ENT] to select the file as the coordinate search file; then return to the <File selection>screen.



Tip:

- The list of file names comprises three pages.
- Input range of the scale factor: 0.50000000~2.00000000 (factory setting 1.00000000)

20.2 File renaming

► Steps

1) Enter the memory mode.

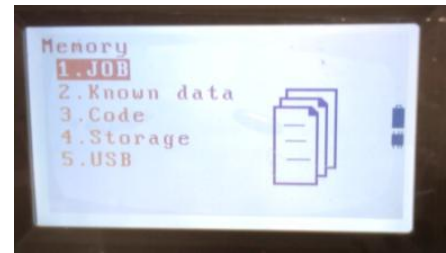

2) Select "File" to enter the <File> menu.

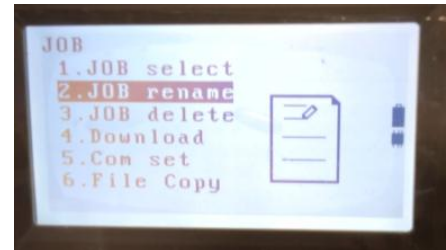

3) Select the file to be renamed as the current file; select "File renaming" to enter the <File renaming> menu.

 Refer to "21.1 File selection"

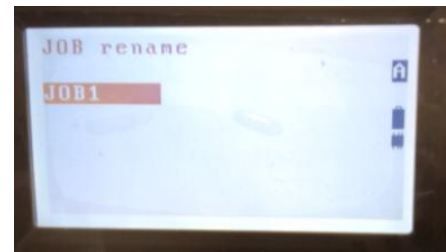

4) Enter a new file name.

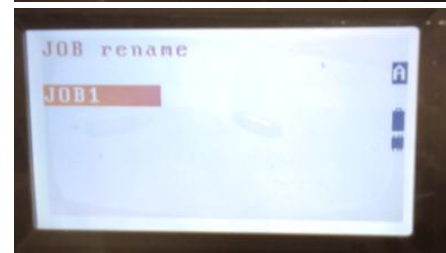

5) Press [ENT] to complete the renaming operation and return to the <File> menu.

 Tip:

- The maximum length of a file name is 12 characters.

20.3 File deletion

Data in a designated file can be cleared. A file whose data are cleared will have its factory file name restored.

► Steps

1) Enter the memory mode.

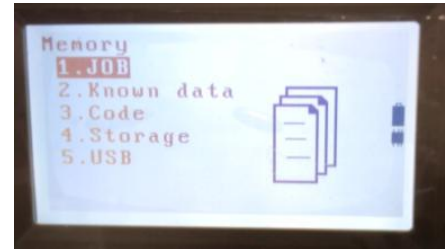

2) Select "File" to enter the <File> menu.

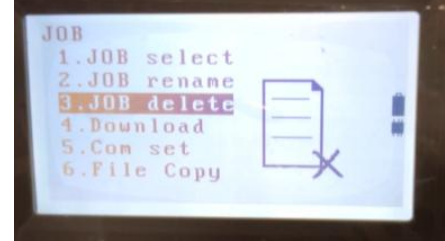

3) Select "File deletion" to enter the <File deletion> menu.

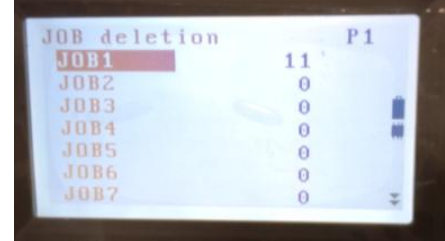

4) Move the cursor to the to-be-deleted file, and then press [ENT].

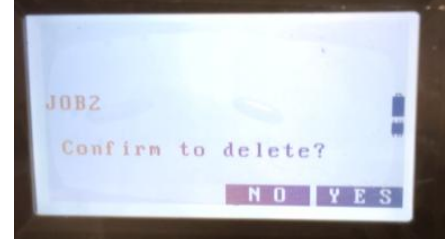

5) Press [F4] (Yes) to delete the selected file and return to the <File deletion> menu.

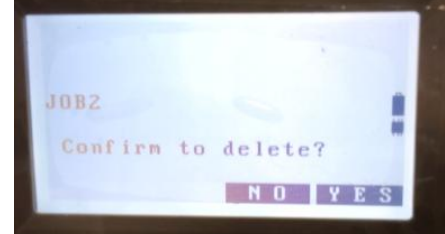

20.4 Communication output

You may transmit data in a designated file via an RS232C communication interface to a computer or other external device.

► Steps

1) Connect the instrument to the computer with a communication cable, and run the data transmission software on the computer.

 Refer to “Connection of the instrument to PC”

2) Set communication parameters of the instrument to be consistent with those of the data transmission software.

 Refer to “26.4 Communication setting”

3) In the memory mode, select “File” to enter the <File> menu.

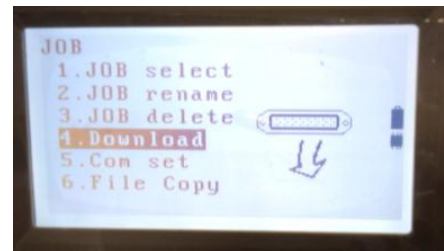

4) Select “Communication output” to enter the <Communication output> menu.

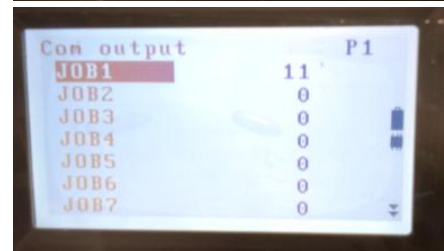

5) Move the cursor to the to-be-output file name, and press [ENT]. The instrument will display the communication output state.

- The transmission of data can be interrupted by pressing [ESC].

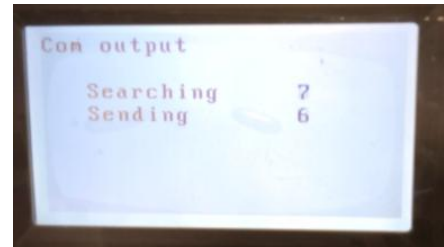

6) Press [ESC] to suspend data output.

21. Known coordinate data manipulation

Known coordinates in the current file can be input or deleted. Known coordinate data input into the instrument in advance can be called for use during measurement as coordinates of an instrument point, rear view point, known point or staking out point.

- The total number of coordinate data record entries and other data record entries may reach up to 120,000.
- Coordinate data input may come from a keyboard or a computer.
- For coordinate data input from a computer, the instrument will not check identical point numbers.
- For input of known coordinate data via communication, you may select “Communication setting” under the <Known data> menu to set the communication parameters.

21.1 Enter known coordinate data by using the keyboard

► Steps

1) Enter the memory mode.

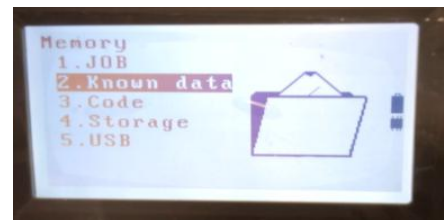

2) Select “Known data” to enter <Known data> menu.

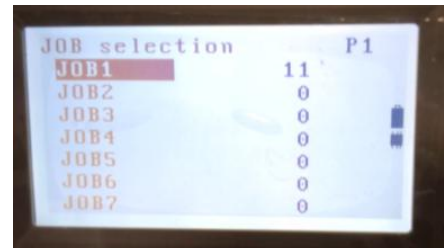

3) Select “Enter coordinates”, and enter.

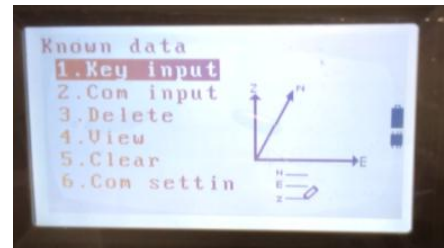

4) Enter the coordinate values and corresponding point number.

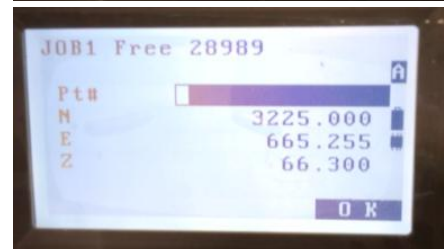

5) Press [F4] (OK) to save the data to the current file and return to the screen of step 3).

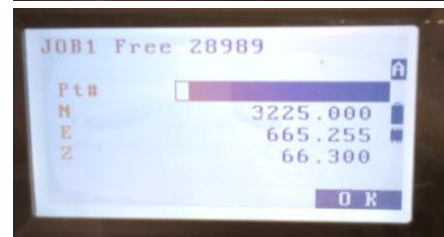

6) Repeat the steps above to continue input of other known coordinate data; when all known coordinate data are entered, press [ESC] to return to the <Known data> screen.

21.2 Enter known coordinate data via communication input

► Steps

- 1) Connect the instrument to the computer with a communication cable, and run the data transmission software on the computer.
- 2) Set communication parameters of the instrument to be consistent with those of the data transmission software.

 Refer to “26.4 Communication setting”

- 3) Enter the memory mode.

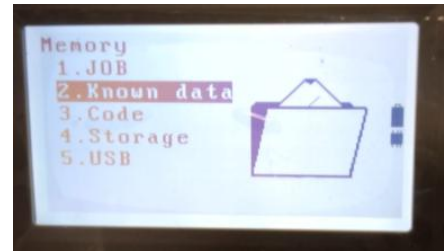

- 4) Select “Known data” to enter <Known data> menu.

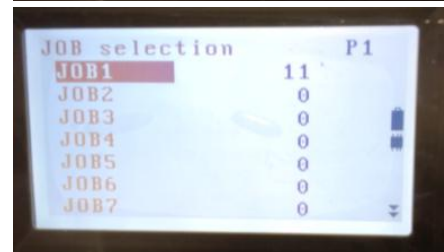

- 5) Select “Communication input” to enter the Wait for communication input screen.

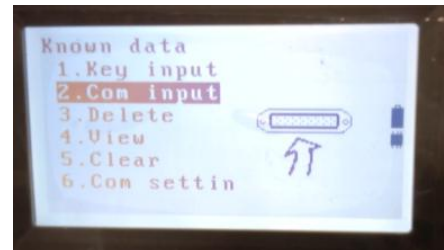

- 6) Operate the computer to transmit coordinates via the data transmission software; numbers of received data entries are shown on the screen; when data transmission is completed, the instrument will return to the <Known data> menu.

- The transmission of data can be interrupted by pressing [ESC].

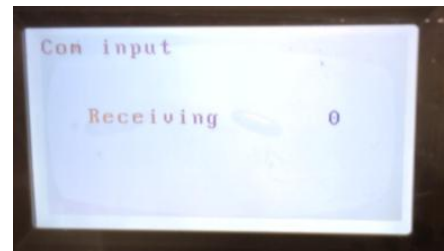

21.3 Delete known coordinate data

► Steps

1) Enter the memory mode.

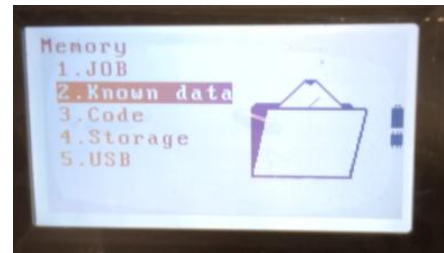

2) Select "Known data" to enter <Known data> menu.

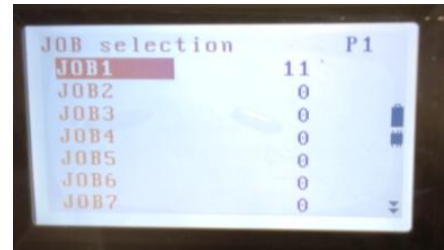

3) Select "Delete coordinate", and enter.

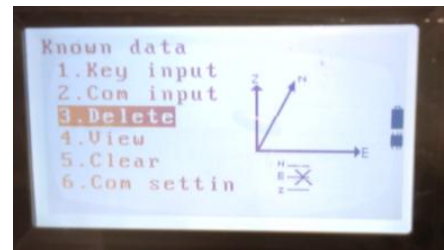

4) Select a to-be-deleted point, and press [ENT].

- Press [F1] (↑↓ P), and then press [▲] / [▼] to display the previous or next page.
- Press [F1] (↑↓ P), and then press [▲] / [▼] to display the previous or next page.
- Press [F2] (First point) to move the cursor to the first point on the first page.
- Press [F3] (Final point) to move the cursor to the final point on the final page.
- Press [F4] (Search) to go to the coordinate data search screen, and enter the point to be searched for searching; if there is a great quantity of known data, the search will last long.

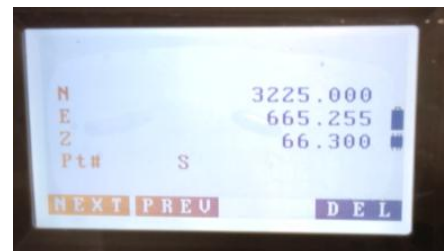
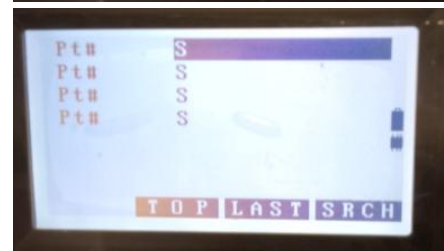

5) Press [F4] (Delete) to delete the specified point.

- Press [F1] (Next) to display the next point data.
- Press [F2] (Previous) to display the previous point data.

6) Press [ESC] to return to the <Known data> screen.

21.4 View known coordinate data

► Steps

1) Enter the memory mode.

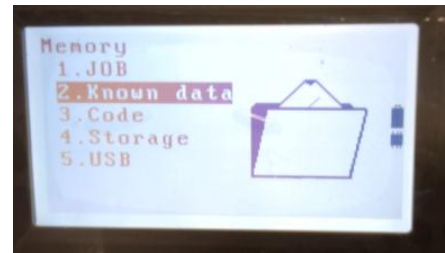

2) Select "Known data" to enter <Known data> menu.

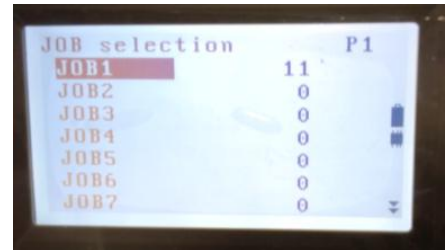

3) Select "Search coordinate", and enter.

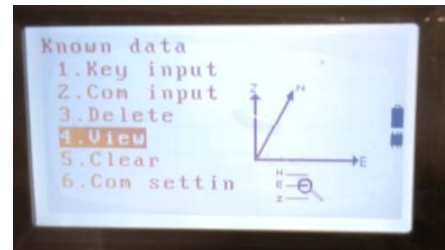

4) Select a to-be-viewed point number, and press [ENT] to show its coordinates.

- Press [F1] ($\uparrow\downarrow$ P), and then press [\blacktriangle] / [\blacktriangledown] to display the previous or next page.
- Press [F1] ($\uparrow\downarrow$ P), and then press [\blacktriangle] / [\blacktriangledown] to display the previous or next page.
- Press [F2] (First point) to move the cursor to the first point on the first page.
- Press [F3] (Final point) to move the cursor to the final point on the final page.
- Press [F4] (Search) to go to the coordinate data search screen, and enter the point to be searched for searching; if there is a great quantity of known data, the search will last long.

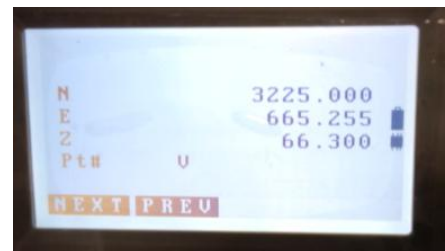

5) Press [ESC] to return to the <Known data> screen.

- Press [F1] (Next) to display the next point data.
- Press [F2] (Previous) to display the previous point data.

21.5 Clear all known coordinate data

► Steps

1) Enter the memory mode.

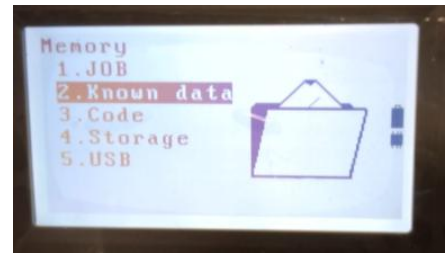

2) Select "Known data" to enter <Known data> menu.

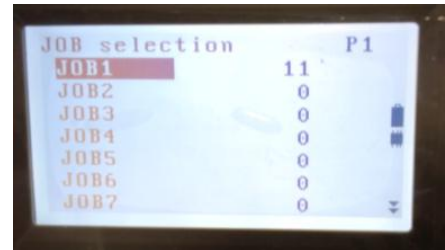

3) Select "Clear coordinates", and enter.

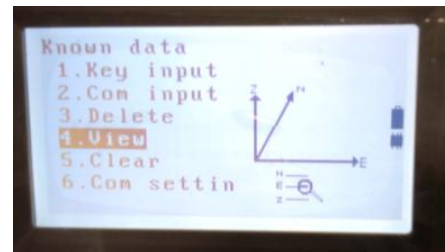

4) Press [F4] (Yes) to confirm clearing all coordinate data and return to the <Known data> menu; press [F3] (No) to cancel the clearing action.

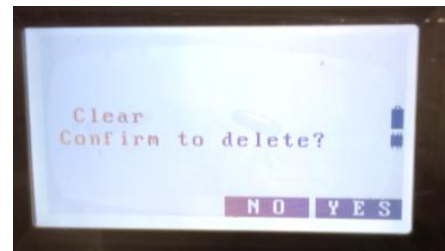

22. Attribute code

Codes can be saved and stored in the instrument memory in advance. Saved codes can be called for use during measurement, and then saved together with instrument data or measurement data.

22.1 Enter attribute code

► Steps

1) Enter the memory mode.

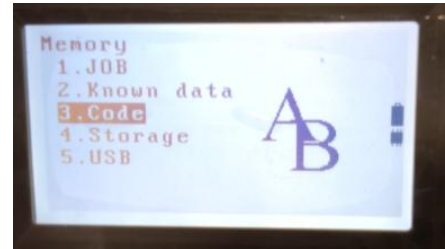

2) Select "Code" to enter the <Code> menu.

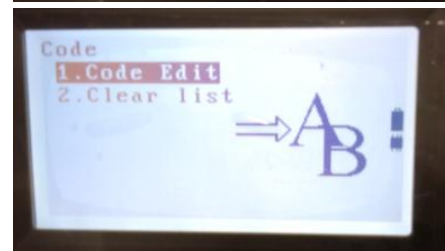

3) Select "Enter code", and enter.

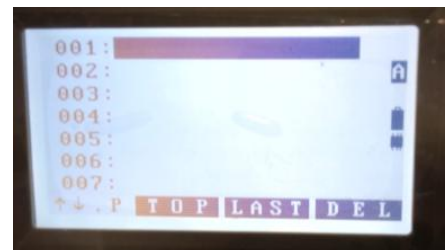

4) Enter an attribute code; then press [ENT] to save the code.



Tip:

- The maximum code length is 16 characters.
- The maximum number of 40 codes can be entered in advance.

22.2 Clear code data

► Steps

1) Enter the memory mode.

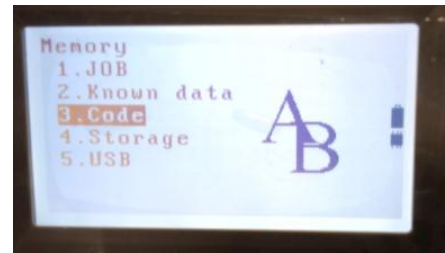

2) Select "Code" to enter the <Code> menu.

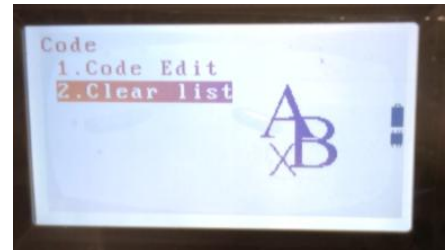

3) Select "Clear all codes", and enter.

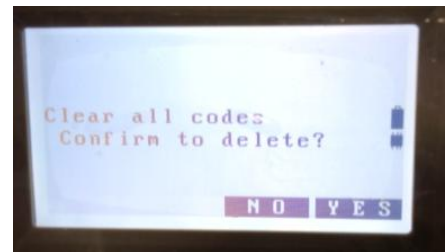

4) Press [F4] (Yes) to clear all code data, and return to the <Code> menu; or press [F3] (No) to cancel the clearing operation.

23. Select storage medium

The Select storage medium function is used to select internal memory or storage card for data storage.

► Steps

1) Enter the memory mode.

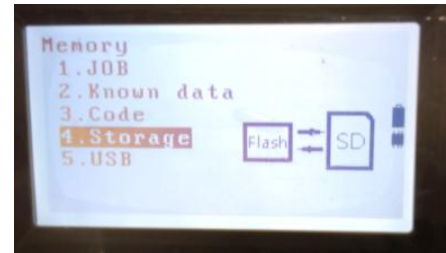

2) Select "Storage selection" to enter the <Storage selection> screen.

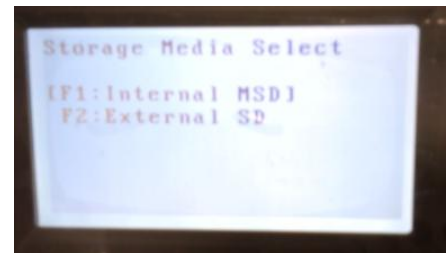

3) Press [F1] to select the internal storage of the instrument for data storage; press [F2] to select SD card for data storage; after selection, the instrument will automatically initialize files and return to the <Internal storage> menu.

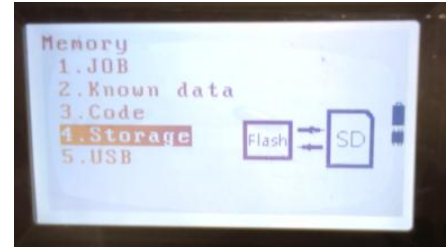

24. USB (USB flash disk) mode

Use the instrument storage as a USB flash disk to display on a computer.

► Steps

1) Connect the instrument by using a USB communication cable, and set it to the internal storage mode.

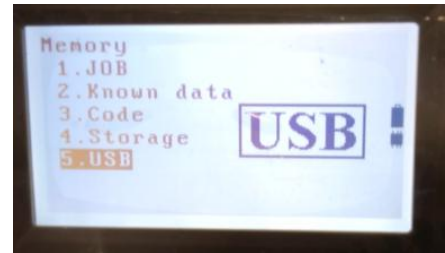

2) Select "USB" and enter; when the screen shown on the right side appears, insert the USB communication cable into the USB port of the computer.



3) When the screen shown on right side appears, it means the instrument is connected, while the instrument storage is displayed on the computer as a USB flash disk drive.

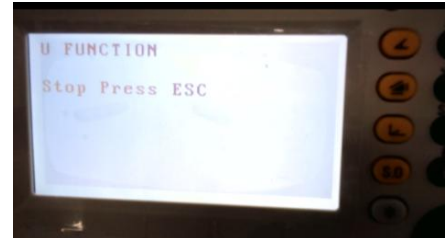

4) Press [ESC] to exit the USB mode and return to the <Internal storage> menu.

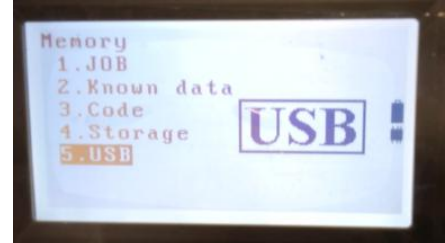

25. Setting of Instrument Parameters

This section introduces setting of instrument parameters, how to change these settings and how to initialize the instrument.

25.1 Setting of parameters relating to distance measurement

This section introduces setting of parameters relating to distance measurement.

► Steps

1) Go to the third page in the measurement mode; press [F1] (EDM) to enter the screen for setting parameters relating to distance measurement.

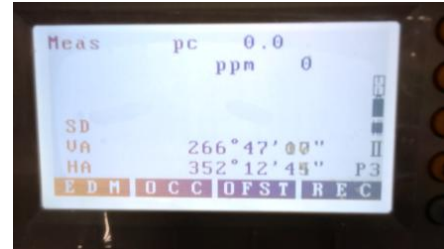

2) Or press [Fn] on any screen, and then press [↵] to enter the screen for setting parameters relating to distance measurement.

- Press [▲] / [▼] to select parameters to be set.
- Press [◀] / [▶], and select "distance measurement mode, reflector".
- Items, including "prism constant, temperature, atmospheric pressure, atmospheric correction", can be set by directly entering numeric values.
- When precise average measurement is selected for the distance measurement mode, you may press [F3] (↑) or [F4] (↓) to change the times of distance measurement.
- You may also press [F1] (0PPM) to set the atmospheric correction to "0", while setting temperature and atmospheric pressure to respective default values.
- The atmospheric correction can be directly entered, or calculated by entering the temperature and the atmospheric press.

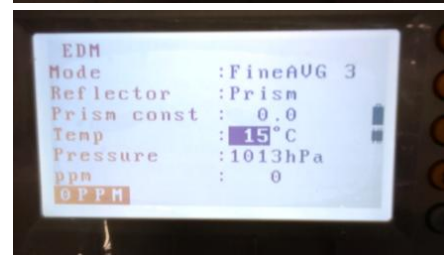
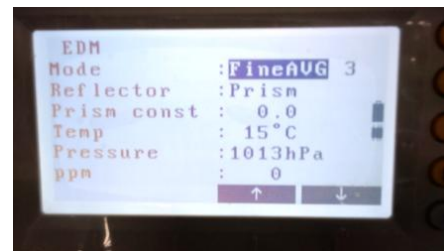

Settings, options and input ranges (items marked with “*” are factory settings)

Distance measurement mode	Repeated precise measurement*, precise average measurement (1~9 times), precise single measurement, coarse single measurement, tracking measurement
Reflector	Prism*, reflector plate, reflectorless
Prism constant	-99~99mm (0*)
Temperature	-20~60℃ (20*)
Air pressure	500~1400h Pa (1013*), 375~1050mmHg (760*)
Atmospheric correction	-499~499 (0*)



Atmospheric correction

The instrument emits a light beam to measure distance. The traveling speed of the light beam in the atmosphere may change with the atmospheric refractive index, which is closely related to the atmospheric temperature and pressure.

- To precisely calculate the meteorological correction, it is required to determine the average atmospheric temperature and pressure along the light beam traveling path. In case of measurement in mountainous areas, it shall be specially noted that the meteorological condition may differ at different elevations.
- The instrument is designed against the temperature of 20℃, the atmospheric pressure of 1013hPa, and the atmospheric correction of “0”.
- The instrument may also calculate corresponding meteorological correction against input temperature and atmospheric pressure, and save the result to its internal memory. The calculation formula is given below:

$$\text{ppm} = 274.417 - \frac{0.2904 \times \text{atmospheric pressure (hPa)}}{1 + 0.0036 \times \text{temperature (}^\circ\text{C)}}$$



Refer to “Appendix 1 Atmospheric correction formula and atmospheric correction graph”

- When no meteorological correction is required, set the ppm value to “0”.
- Alternatively, automatic atmospheric correction can be selected.



Refer to information on automatic correction in “26.2 Setting of observation conditions”



Prism constant

Different prisms have different prism constant corrections. Before measurement, it is required to set the prism constant correction. When the reflector type is set to “Reflector plate” or “Reflectorless”, the prism constant correction will be automatically set to “0”.

25.2 Setting of observation conditions

This section introduces setting of observation conditions and how to change these settings.

► Steps

1) On the main screen, press [F4] (Setting) to enter the <Setting> menu.

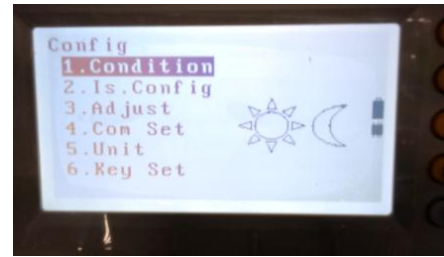

2) Select "Observation conditions", and enter.

- Press [▲] / [▼] to select parameters to be set.
- Press [◀] / [▶] to select options; in <Observation conditions>, all items have options for selection.
- Press [*] to turn pages of the observation conditions.

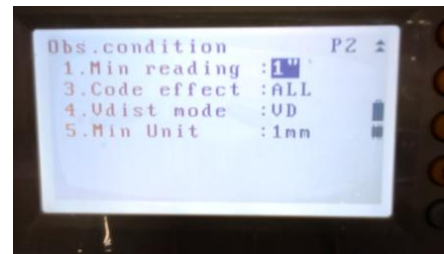

Settings, options and input ranges (items marked with "*" are factory settings)

Distance measurement mode	Slope distance *, horizontal distance, vertical difference
Tilt correction	XONYON*, XONYOFF, XOFFYOFF
Two-difference correction	.14*, .20, NO
Vertical angle type	Zenith distance*, vertical angle, perpendicular 90
Horizontal angle type	HAR*, HAL
Vertical angle buzzer	No*, Yes
Coordinate format	NEZ*, ENZ
Least display	1"* , 5" , 10"
Code valid	For all*, for once
Vertical difference mode	VD*, GD
Least unit	1mm*, 0.1mm

 Automatic inclination compensator

The instrument relies on a double-axis inclination sensor to automatically offset any error occurring to the vertical and horizontal angles due to slight inclination after leveling.

- After the display becomes stable, you may read the automatically compensated angle.
- A vertical axis error may affect the horizontal angle. Hence, if the instrument is not fully leveled, rotating the telescope vertically will also result in change of the displayed horizontal angle.

Corrected horizontal angle = measured horizontal angle + inclination/Tan (vertical angle)

- When the telescope collimates the zenith or nadir attachment, no compensation of the horizontal angle will be made by the instrument.

 Refer to “3.8 Tilt correction of vertical and horizontal angles”

 Two-difference correction

 Upon distance measurement, the instrument has considered the atmospheric refraction and earth curvature correction.

 Refer to “Appendix 2 Atmospheric refraction and earth curvature correction”

 Vertical angle display format

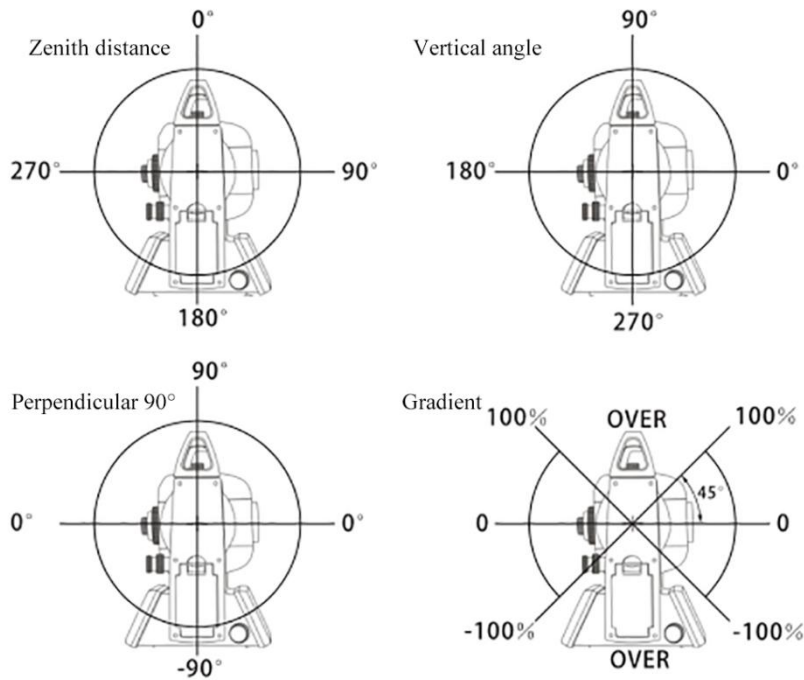

 Vertical angle buzzer

If the straight angle buzzer is enabled, it will sound when the horizontal angle of the instrument falls within 0°, 90°, 180° or 270°±1°, and stop sounding when the horizontal angle is adjusted to 0°00'00" (±2").

 Automatic correction

Automatic correction of atmospheric pressure and temperature conditions may affect accuracy of the instrument in distance measurement, and thus shall be carefully set when precise measurement is required.

25.3 Instrument setting

This section introduces some basic settings of the instrument and how to change these settings.

► Steps

1) On the main screen, press [F4] (Setting) to enter the <Setting> menu.

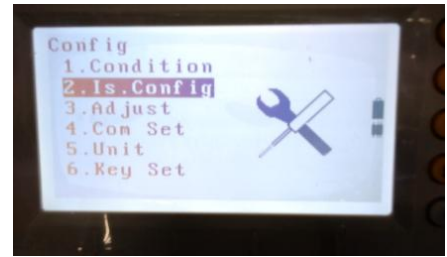

2) Select "Instrument setting", and enter.

- Press [▲] / [▼] to select parameters to be set.
- Press [◀] / [▶] to select an option; in <Instrument setting>, all items have options for selection.



Settings, options and input ranges (items marked with "*" are factory settings)

Way of shutdown	5 minutes, 10 minutes, 15 minutes*, 30 minutes, NO
Contrast	Level 0~13 (9*)
Reticle brightness	Level 0 - 9 (7*)



Automatic shutdown for power saving

The instrument will automatically shut down if no operation occurs in a specified period.

25.4 Communication setting

This section introduces some communication settings of the instrument and how to change these settings.

► Steps

1) On the main screen, press [F4] (Setting) to enter the <Setting> menu.

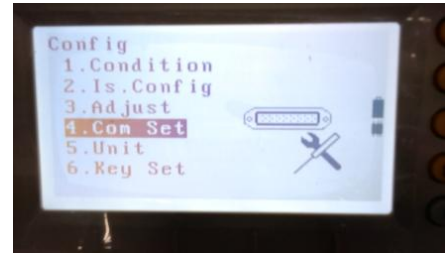

2) Select “Communication setting”, and enter.

- Press [▲] / [▼] to select parameters to be set.
- Press [◀] / [▶] to select an option; in <Instrument setting>, all items have options for selection.



Settings, options and input ranges (items marked with “*” are factory settings)

Baud rate	1200*, 2400, 4800, 9600, 19200, 38400
Data bit	7 bits, 8 bits*
Parity	NO*, even, odd
Stop Bit	1 bit*, 2 bits
Sum check	Yes, No 0*
Stream control	Yes*, No

25.5 Unit setting

This section introduces some unit settings and how to change these settings.

► Steps

1) On the main screen, press [F4] (Setting) to enter the <Setting> menu.

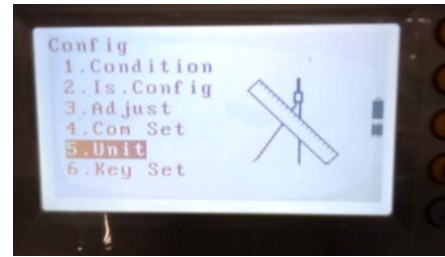

2) Select "Unit setting", and enter.

- Press [▲] / [▼] to select parameters to be set.
- Press [◀] / [▶] to select an option; in <Instrument setting>, all items have options for selection.

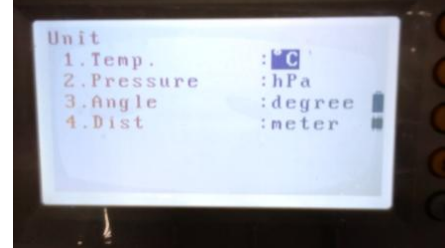

Settings, options and input ranges (items marked with "*" are factory settings)

Temperature	°C*, °F
Air pressure	hPa*, mmHg, inchHg, mbar, psi
Angle	ddegree *, gon, mil, dec.deg
Distance	meter*, Us-ft, Int-ft

25.6 Key setting

This section introduces some functional software settings and how to change these settings.

► Steps

1) On the main screen, press [F4] (Setting) to enter the <Setting> menu.

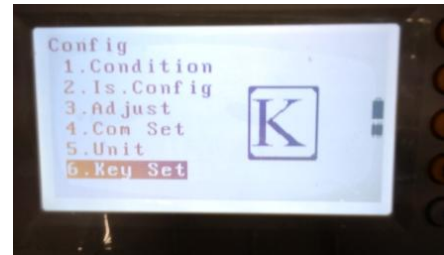

2) Select “Key definition”; enter and select “Key setting”.

- Press “Key saving” to set user 1 and user 2.
- Press “Key resetting” to restore the default setting.

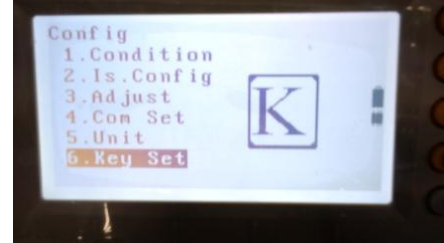

3) Press [▲] / [▼] to switch to the current functional software setting;

press [◀] / [▶] to switch the functional software.

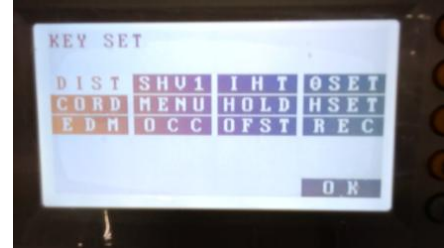

4) When setting is done, press [F4] (OK) to end the setting.

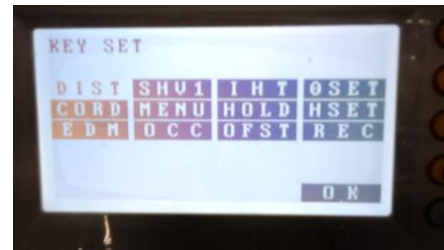

5) Similarly, you can also set a softkey after pressing [!] and a digit key (1~9); when the setting is done, press [F4] (OK) to end the setting.

- Press [F1] (Resetting) to restore the default settings.



26. Check and correction

26.1 Check and correction of instrument constants

Before delivery out of the factory, the instrument has its distance plus constant calibrated to zero. Considering the distance plus constant may change, it shall, if possible, be subject to regular precise measurement based on the existing baseline, or if impossible, be measured by using the following method.

 Note:

- Both centering error and collimation error of the instrument and prism may affect the measurement result of distance plus constant, and thus special care should be taken to reduce these errors during inspection. Besides, it is also required to make the instrument and prism of equal height; when detection is performed on uneven ground, a level should be used to measure the instrument height and the prism height.

► Check steps

1) Select two points A and B on the flat ground that are about 100m away from each other; set the instrument and a prism at points A and B, respectively; select a point C in the middle of the straight line connecting points A and B.

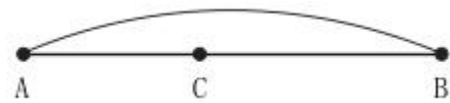

2) Precisely measure the horizontal distance between A and B for 10 times, and calculate the average value.

3) Move the instrument to C, and set prisms at points A and B.

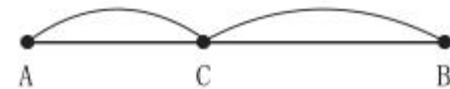

4) Precisely measure the horizontal distance between C and A and between C and B for 10 times; calculate respective average values.

5) Calculate the distance plus constant by using the following formula:

$$K = AB - (CA + CB)$$

6) Repeat steps 1) to 5) to measure the distance plus constant for two to three times; if the distance plus constant obtained through the measurements always falls within ± 3 mm, then no correction is required; or otherwise contact the marketing department or service center of the manufacturer or its representative office.

26.2 Check and correction of tubular level

► Check steps

- 1) Place the instrument on a stable device (such as a tripod or instrument calibration table), and fix it.
- 2) Roughly level the instrument; make the tubular level parallel to a line connecting two of the three foot screws on the base; adjust the two foot screws to set the tubular level bubble at the center.

Refer to steps 3) to 5) in “3.2 Leveling”

- 3) Rotate the instrument by 180° , and observe how the tubular level bubble moves; if the bubble is at the center of the tubular level, no correction is required; or otherwise if the bubble moves out of the permitted range, adjustment shall be made.

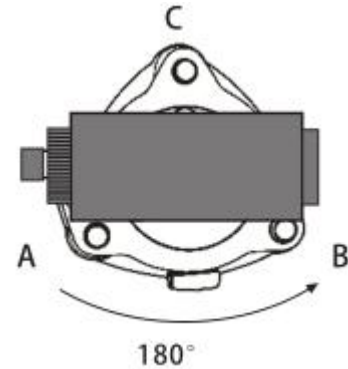

► Correction steps

- 1) Place and fix the instrument onto a stable device.
- 2) Roughly level the instrument.
- 3) Rotate the instrument to make its tubular level parallel to a line connecting two of the three foot screws on the base; adjust the two foot screws to set the tubular level bubble at the center.
- 4) Rotate the instrument by 180° ; when the bubble gets stable, make fine adjustment of the screws by using a calibration pin, driving the bubble to move toward the tubular level center by half distance.
- 5) Repeat steps 3) and 4) until the bubble can remain at the center of the tubular level when the tubular level rotates to any position after precise leveling.

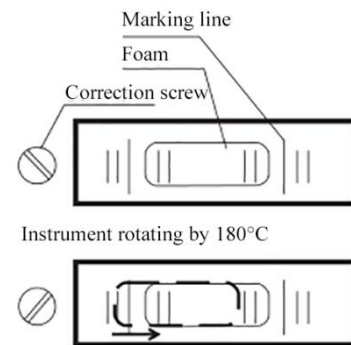
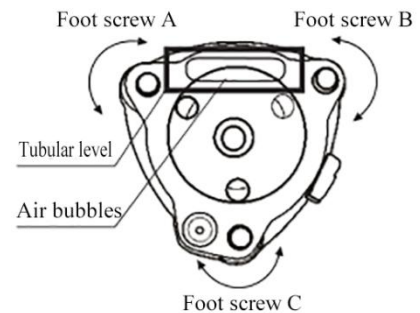

Tip:

- If you cannot center the bubble following the calibration process above, please contact the manufacturer or the distributor.

26.3 Inspection and calibration of the circular level

► Check steps

1) Place and fix the instrument onto a stable device; use the tubular level for precise leveling of the instrument;

☞ Refer to steps 3) to 5) in “3.2 Leveling”

2) Observe if the circular level bubble is centered; if it is, no correction is required; or otherwise if the bubble moves out of the range, adjustment should be made.

► Correction steps

1) Place and fix the instrument onto a stable device; use the tubular level for precise leveling of the instrument.

☞ Refer to steps 3) to 5) in “3.2 Leveling”

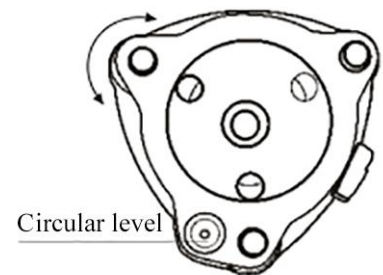

2) Adjust the three correction screws by using an allen wrench to make the bubble at the center of the circular level.

Circular level
Correction screw

Base bottom

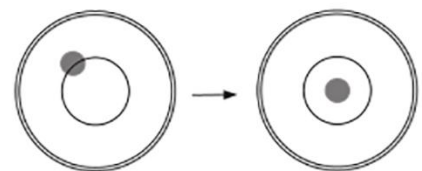

💡 Tip:

- If you cannot center the bubble following the calibration process above, please contact the manufacturer or the distributor.

26.4 Check and correction of the telescope's coarse sighting device

► Check steps

- 1) Put the instrument on a tripod and fix it.
- 2) Set a cross mark target 50m away from the instrument.
- 3) Collimate the telescope of the instrument to the cross mark target.
- 4) Observe if the coarse sighting device collimates the cross mark; if it does, no correction is required; or otherwise if it deviates, adjustment should be made.

► Correction steps

- 1) Put the instrument on a tripod and fix it.
- 2) Set a cross mark target 50m away from the instrument.
- 3) Collimate the telescope of the instrument to the cross mark target.
- 4) Loosen the 2 screws fixing the coarse sighting device, adjust the device to a proper position, and then tighten the 2 screws.

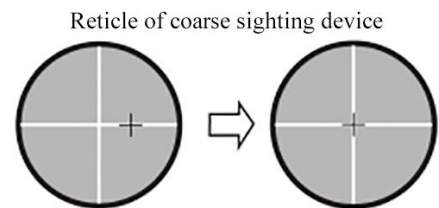
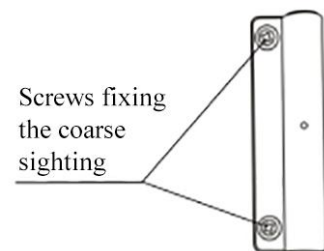

26.5 Check and correction of laser centering device

► Check steps

- 1) Set the instrument on a tripod and fix it.
- 2) Put a mark right under the instrument.

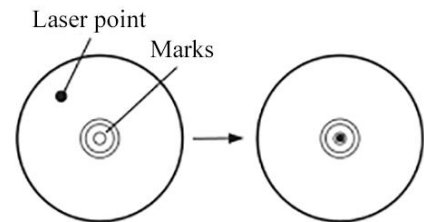

- 3) Turn the three foot screws on the instrument base to make the laser point overlap with the cross mark on the ground.

Protective cover screw



- 4) Rotate the instrument by 180°; observe if the laser point overlaps with the cross mark on the ground; if it does, no correction is required; if it deviates, adjustment should be made.

► Correction steps

- 1) Remove the instrument from the three-jaw base;
- 2) Turn screws on the protection cover at the bottom of the instrument counterclockwise, and remove the protective cover;
- 3) Remount the instrument onto the three-jaw base;
- 4) Fix the instrument on the tripod, and place a cross mark right below it;
- 5) Turn the foot screws on the instrument base to make the laser beam centering point overlap with the cross mark on the ground;
- 6) Turn the instrument horizontally by 180°; make fine adjustment of two screws by using a calibration pin, moving the cross mark on the ground toward the laser beam centering point by half distance (there are totally three screws, and the one shown in the right figure may not be adjusted by using a calibration pin).
- 7) Repeat steps 5 and 6 until the cross mark on the ground always overlaps with the laser beam centering point when the instrument is turned to any direction.



26.6 Check and correct the vertical line of telescope reticle

If the vertical line of the reticle is not perpendicular to the horizontal axis of the telescope, correction is required (because one point on the vertical line may be used to collimate the target for horizontal angle measurement or for vertical staking).

Inspection procedures

- 1) Set the instrument on a tripod and precisely level it.
- 2) Set a point A at 50m away from the instrument.
- 3) Collimate the instrument's telescope to point A, and turn the vertical inching hand wheel; if point A moves along the vertical line of the reticle, no adjustment is required; or otherwise if it deviates from the vertical line, adjustment should be made.

► Correction steps

- 1) Place the instrument and set point A at 50m away.
- 2) Turn the protective cover of the reticle counterclockwise, and remove the cover to expose the four screws fixing the eyepiece.
- 3) Use a cross screwdriver to slightly loosen the four screws fixing the reticle.
- 4) Turn the eyepiece end until the vertical line of the reticle overlaps with point A; finally tighten the four screws fixing the reticle.
- 5) Repeat calibration until point A always moves along the vertical line of the reticle.

Screws fixing the reticle

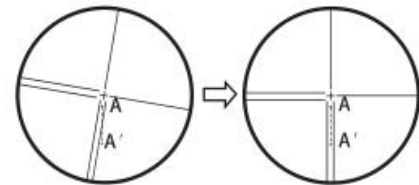
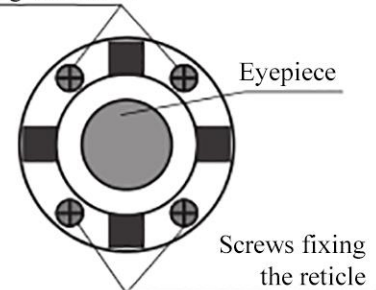

Tip:

- If the vertical line of the reticle is calibrated, please check the collimation error and index error of the instrument after calibration.
- Upon completion of the calibration above, please check the coaxiality of the EDM optical axis and sighting axis for distance measurement.

Refer to “27.10 Optical axis and telescope sighting axis for distance measurement”

- Upon completion of the calibration above, please check to make sure C value falls within the required range.

Refer to “27.7 Check and correct the instrument collimation error”

26.7 Check and correct the instrument collimation error

When the telescope sighting axis is not perpendicular to the horizontal axis, the angle C at which it deviates from its vertical position is called the sighting error or collimation error. Though best efforts are made to satisfy specified requirements upon installation of the instrument, it is impossible to realize exact consistency; besides, transport and use of the instrument may also incur collimation errors. Therefore, collimation error is objectively present.

► Check steps

1) Place the instrument on a stable device or a tripod and precisely level it.

 Refer to steps 3) to 5) in “3.2 Leveling”

2) Sight the cross line of the collimator reticle or a visible object at distance; observe through the left circle and then through the right circle.

3) Obtain the left circle reading H_l and right circle reading H_r ; calculate the collimation error $C = (H_l - H_r \pm 180^\circ) / 2$;

If $C < 8''$, no adjustment is required; if $C > 8''$, adjustment should be made.

► Correction steps

1) Place the instrument on a stable device or a tripod and precisely level it.

 Refer to steps 3) to 5) in “3.2 Leveling”

2) At the reverse lens position, turn the flat plate inching hand wheel to make the reverse lens reading $H_r' = H_r + C$.

3) Loosen screws fixing the protective cover of the telescope reticle.

4) Adjust the left and right adjusting screws to make the telescope reticle and collimator or target at distance overlap.

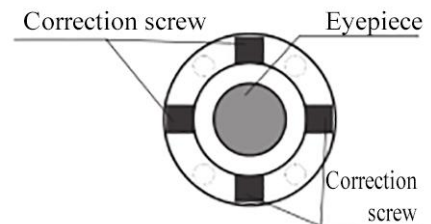

5) Repeat verification and correction until conformity is realized.



Tip:

- First loosen the correction screw at the end to which the vertical line of the reticle will move; then tighten the correction screw on the other end to the same amount. Turn counterclockwise for loosening, and clockwise for tightening. The turning amount shall be the same as far as possible.
- Upon completion of the calibration above, please check the coaxiality of the EDM optical axis and sighting axis for distance measurement.

 Refer to “27.10 Optical axis and telescope sighting axis for distance measurement”

26.8 Check and correct the index error i of the vertical circle

The inconsistency between the physical zero position of the vertical circle and the horizontal direction incurred by reason of installation is the installation index error of the vertical circle. Upon vertical angle measurement, it is required to consider both and apply a simple addition/subtraction means in the program to offset the error, namely electronic compensation of the installation index error. The purpose of vertical circle correction is to calculate the installation index error of the vertical circle and provide data for correction by software. Since the correction may affect correctness of the measured data, do operate in strict observation of the Manual.

As the installation index error of the vertical circle is closely related to the zero position of the compensation, it is required to test and correct the zero position of the compensator in the X direction upon correction of the vertical circle; upon reading, the tilt value should be basically stable.



Tip:

- This verification and correction should be performed after reticle correction and 2C error correction.

 Refer to “27.6 Check and correct the vertical line of telescope reticle” and “27.7 Check and correct the instrument collimation error”

► Check steps

1) Place the instrument on a stable device or a tripod, precisely level it and turn it on.

 Refer to steps 3) to 5) in “3.2 Leveling”

2) Collimate the telescope respectively at the left and right circle positions to a collimator reticle of around $\pm 10^\circ$ vertical angle or a target at distance, to obtain the left circle reading V_l and the right circle reading V_r .

3) Calculation: Index error $i = (V_l + V_r - 360^\circ) / 2$.

4) If the index error is less than $10''$, no correction is required; if it is greater than $10''$, adjustment should be made.

► Correction steps

1) On the main screen, press [F4] (Setting) to enter the <Setting> menu.

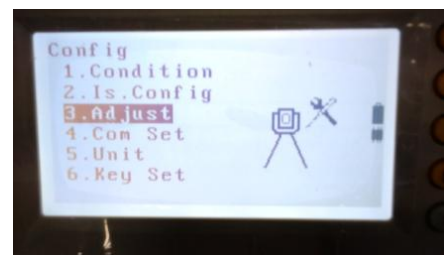

2) Select “Instrument correction” to enter the <Instrument correction> screen. Instrument correction

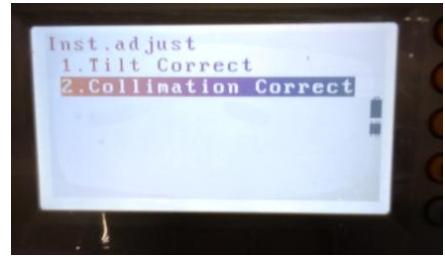

3) Select “Sighting error correction” to enter the <Sighting error correction> screen.

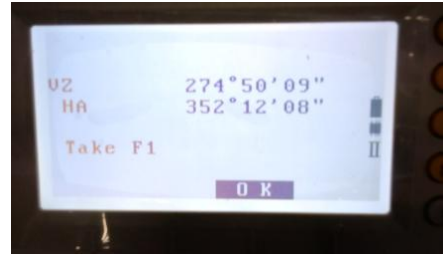

4) Collimate the left circle precisely to a reference point, and then press [F3] (OK).

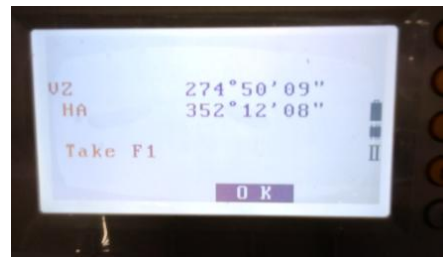

5) Turn the alidade by 180°; collimate the right circle precisely to the same reference point, and then press [F3] (OK).

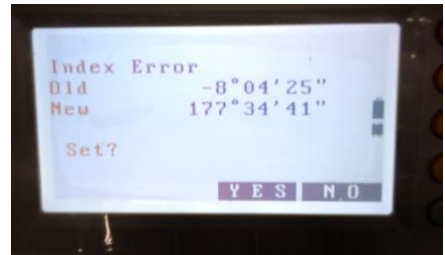

6) Press [F3] (Yes) to set the index error correction, and return to the <Instrument correction> screen.

- Press [F4] (No) to cancel the setting, and return to the <Instrument correction> screen.



Tip:

- If the index error cannot be calibrated to the specified range through the process above, please check the zero position error of the compensator.

Refer to “27.9 Check and correct zero position error of the tilt compensator”

26.9 Check and correct zero position error of the tilt compensator

After precise leveling of the instrument, the tilt angles displayed of the left and right circles shall add to approximate zero; or otherwise it means there is a zero position error of the tilt compensator that may affect the measurement result. You may calibrate zero position of the tilt compensation following the steps below.

► Calibration steps

1) Precisely level the instrument.

 Refer to steps 3) to 5) in “3.2 Leveling”

2) Tighten the horizontal braking screw; on the first page menu in the measurement mode, press [F4] (Zero setting) to set the horizontal angle to zero.

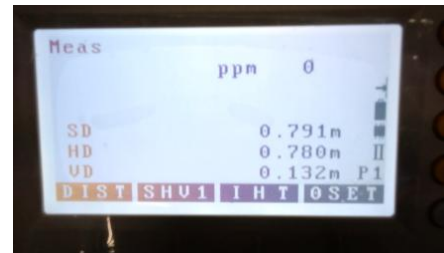

3) On the main screen, press [F4] (Setting) to enter the <Setting> menu.

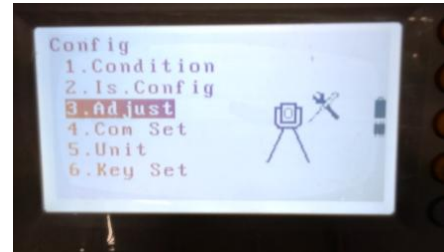

4) Select “Instrument correction” to enter the <Instrument correction> screen. Instrument correction

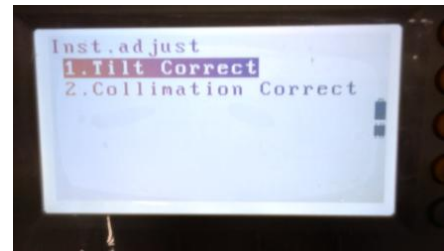

5) Select “Compensator correction” and enter; wait a minute, and then read the automatically compensated tilt angles X1 and Y1.

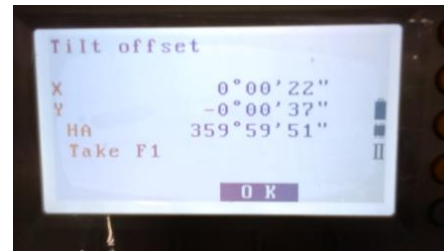

6) Loosen the horizontal braking screw to rotate the alidade by 180°, and then tighten the horizontal braking screw. Wait a minute, and then read the automatically compensated tilt angles X2 and Y2.

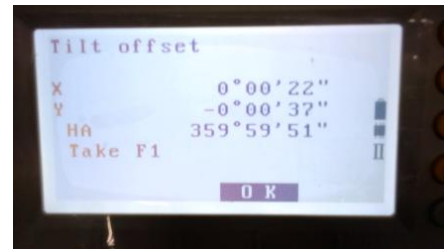

7) Use the following formulas to calculate the zero position error of the tilt compensator:

Deviation in X direction = $(X1 + X2) / 2$

Deviation in Y direction = $(Y1 + Y2) / 2$

If the deviations obtained through calculation falls within $\pm 20''$, no correction is required; or otherwise follow the steps for correction.

8) Press [F3] (OK) to save X2 and Y2, and "Right circle reading" will appear on the screen.

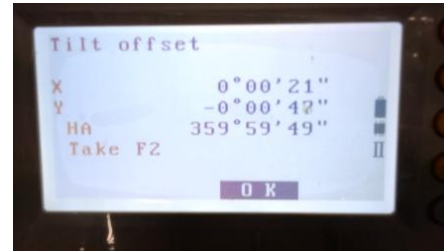

9) Loosen the horizontal braking screw to rotate the alidade by 180°, and then tighten the horizontal braking screw.

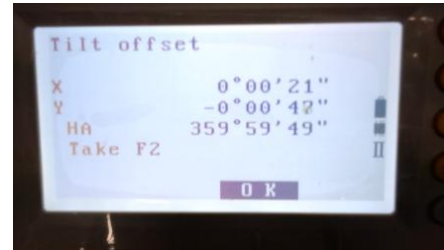

10) Wait a minute, and then press [F3] (OK) to save X1 and Y1. The screen will display the original correction and the new correction in the X and Y directions.

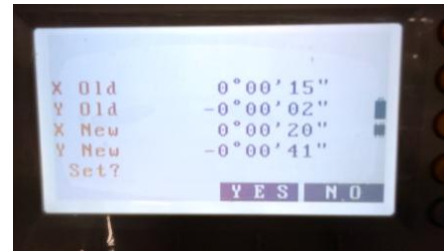

11) Press [F3] (Yes) to save the new of X and Y values. Return to the <Instrument correction> screen.

- Press [F4] (No) to save the new X and Y values.



Tip:

- If the right screen appears during calibration, please contact the manufacturer or the distributor.

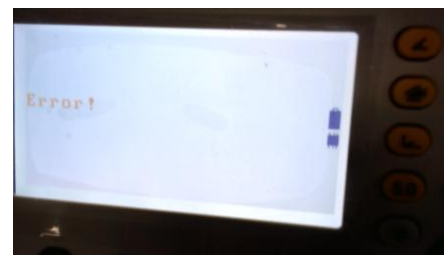

26.10 Optical axis and telescope sighting axis for distance measurement

Check optical axes of the rangefinder and theodolite for consistency; after correction of the eyepiece reticle, make sure to perform this check and correction.

► Check steps

- 1) Place the instrument on a stable device or a tripod, precisely level it and turn it on.
- 2) Attach the reflector plate supplied along at 5m~20m away from the instrument.
- 3) Collimate the reflector plate, and align the reticle with that on the reflector plate.
- 4) Set the instrument to the signal test mode.

📖 Refer to “5.1 Distance and angle measurement”

5) Generally, you cannot see the red laser point through a telescope. You may observe the target from above or side of the telescope. If the laser point hits on the reticle, then the precision requirement is satisfied. If the laser point hits beyond the limited scope of the reticle, then the laser beam should be adjusted.

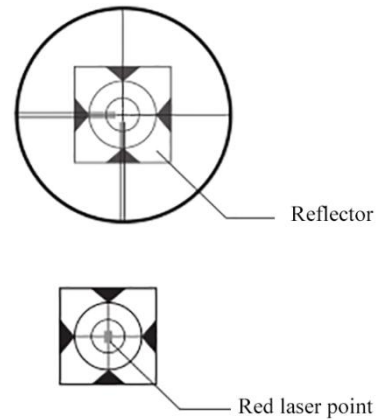

Tip:

- If adjustment is required, please contact the manufacturer or distributor.

27. Attachments

• Packing container	1
• Main unit	1
• Spare onboard battery	1
• Charger	1
• Rinse aid	1
• Conformity certificate	1
• Packing list	1
• Operation Manual of the instrument	1
• Software CD supplied along the instrument	1
• RS-232C communication cable	1
• Calibration pin	2
• Lens wiping cloth	1 piece
• Screw driver	1
• Internal hexagonal wrench	1
• Lens brush	1
• Reflector (30×30mm)	4
• Reflector (60×60mm)	1

Appendix 1: Atmospheric correction formula and atmospheric correction graph (only for reference)

Standard setting value of the instrument: 20°C, 1013hpa, 0ppm

Atmospheric correction:

$$K_{pt} = 278.960 - 0.2902 * p / (1 + 0.0036 * t) \dots\dots\dots E3$$

Where:

p – atmospheric pressure (hPa)

t-temperature (°C)

K_{pt}-atmospheric correction (ppm)

Example:

t=20°C, p=1013hpa, L₀=1000m

Then: K_{pt}=4ppm

$$L = L_0 (1 + K_{pt}) = 1000 \times (1 + 4 \times 10^{-6}) = 1000.004m$$

The atmospheric correction can be found on the atmospheric correction graph. The horizontal axis represents temperature, the vertical axis represents atmospheric pressure, and the diagonals represent required atmospheric correction.

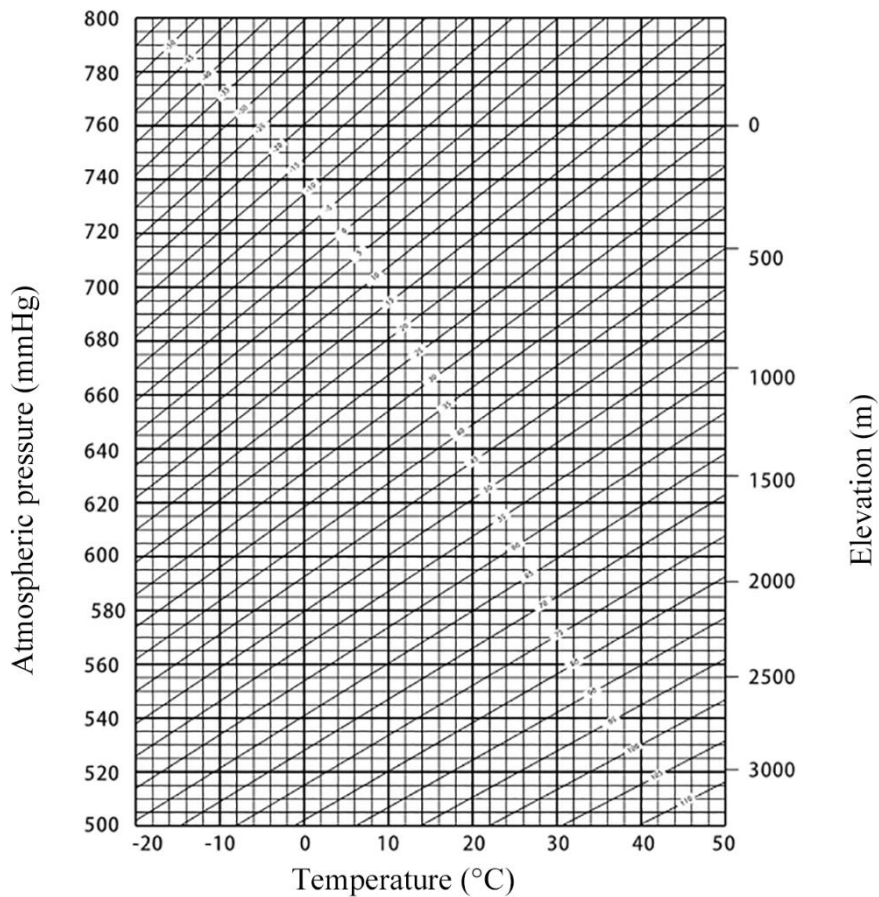

Appendix 2: Atmospheric refraction and earth curvature correction

Considering possible distance-measuring error resulted from atmospheric refraction and earth curvature, the instrument calculates the slope distance, horizontal distance and height difference by using the following formulas, and automatically applies correction of the earth curvature and average atmospheric refraction ($K=0.14$ or 0.20). Average calculation is relative to the instrument elevation other than the telescope elevation.

$$SD = D_0 \times (1 + \text{ppm} \times 10^{-6}) + \text{mm}$$

SD—slope distance shown on the instrument (m)

D_0 —uncorrected distance (m)

ppm—scale correction coefficient (mm/km)

mm—prism constant (mm)

$$HD = Y - A \times X \times Y$$

$$VD = X + B \times Y^2$$

HD—horizontal distance (mm)

VD—vertical difference (mm)

$$Y = SD |\sin \xi|$$

$$X = SD \cos \xi$$

ξ —zenith distance reading

$$A = \frac{1 - \frac{K}{2}}{R}$$

$$B = \frac{1 - \frac{K}{2}}{2R}$$

$K = 0.142$ or 0.20

$R = 6.37 \times 10^6$ (m)

Without considering distance measurement error caused by atmospheric refraction and earth curvature correction, the horizontal distance (HD) and vertical distance (VD) can be calculated by using the formula:

$$HD = SD \cos \xi$$

$$VD = SD |\sin \xi|$$

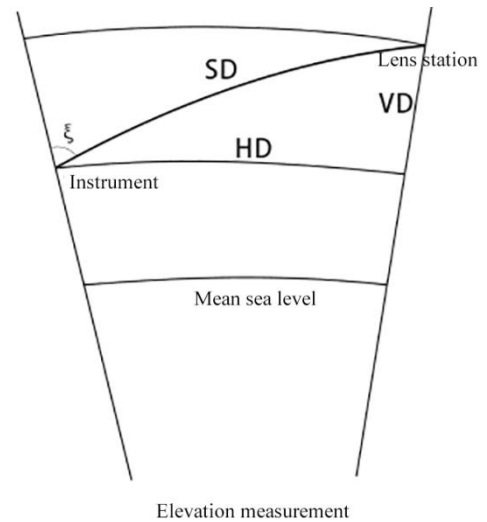

Note: Before delivery of the instrument out of the factory, the atmospheric refraction coefficient is set to 0.142; to modify the K value, refer to section 3.10.

Appendix 3: Removal of three-jaw base

Loosen or tighten the fixing rod screw to remove the instrument from or install it onto the three-jaw base.

- Remove the tester
 - ① Turn the fixing screw of the three-jaw base counterclockwise to loosen the fixing rod.
 - ② Hold the instrument handle tight with one hand and the three-jaw base with another hand; lift the instrument to remove it.
- Install the instrument
 - ① Hold the instrument handle with one hand and put the instrument onto the three-jaw base; align the lower aligning plate to the aligning slot on the three-jaw base.
 - ② Turn the fixing rod screw of the three-jaw base clockwise to tighten the rod.

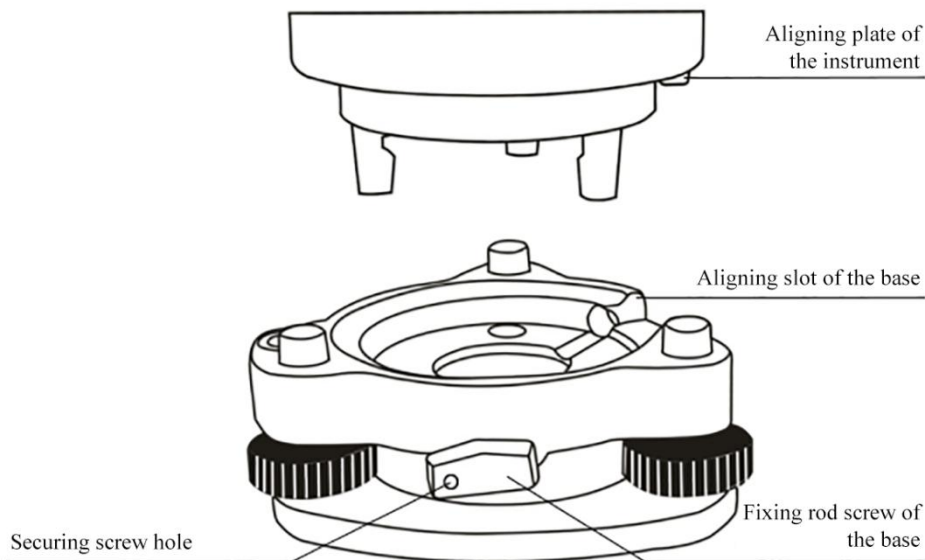

- Lock the fixing rod screw of the three-jaw base to prevent unexpected loosening of the screw. This function is particularly necessary if it is not needed to frequently install and remove the upper part of the instrument. It is only required to screw out the securing screw in the screw hole on the fixing rod by using a screwdriver supplied along among the accessories.

*To be the leading provider of high-precision professional,
solution & service in the global geospatial industry*



Shanghai eSurvey GNSS Co., Ltd.

Address: Building 4, No.651 Wanfang Rd, Pujiang Town, Minhang District, Shanghai, China

E-mail: Sales: info@esurvey-gnss.com Support: support@esurvey-gnss.com

Tel.: +86 21 54467213

Website: <https://esurvey-gnss.com/>